

CEILING SHAPES SMALL INSTALL GUIDE

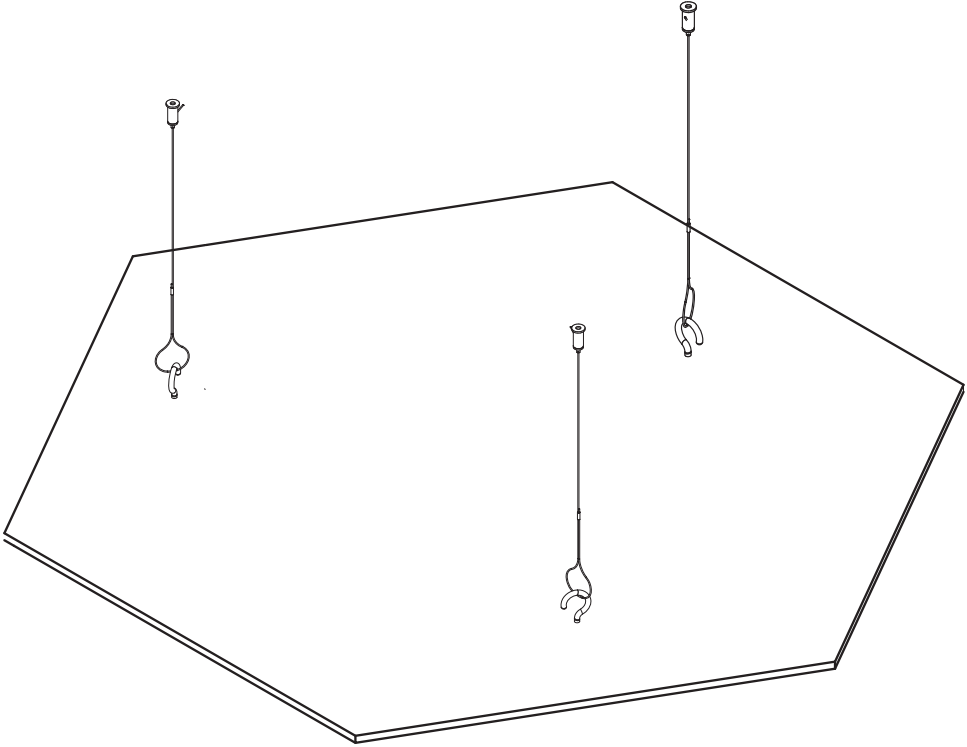

zindra
zindraacoustic.com

CEILING SHAPES SMALL ASSEMBLY

1) Using provided template to match ceiling shape, mark position of **3 off** cup hooks on back of ceiling shape and screw in eye hooks.

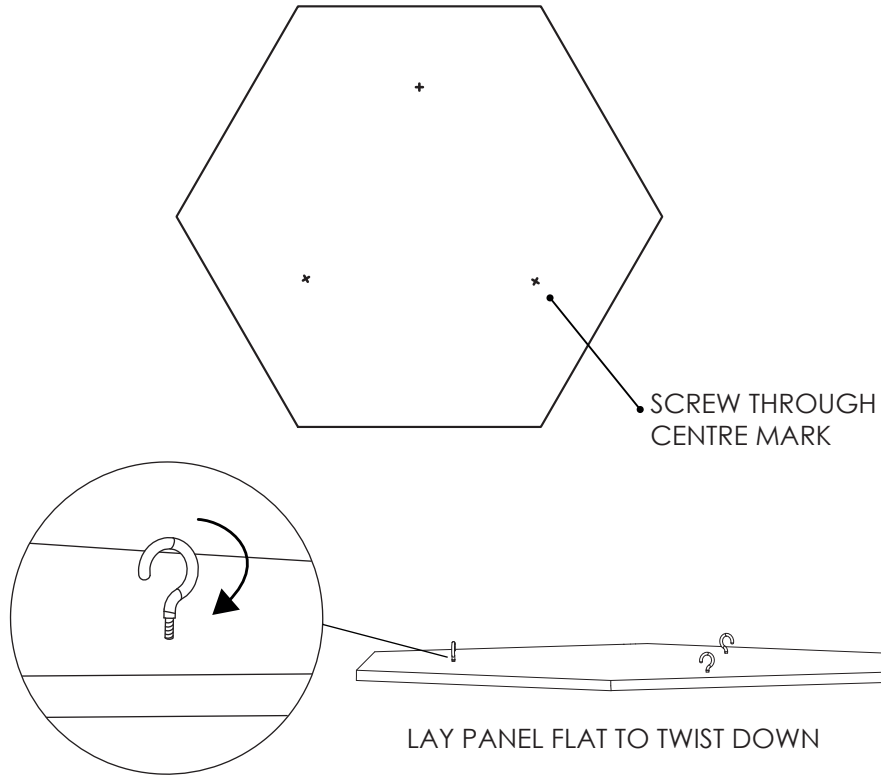

STEP 1

2) Place template up to ceiling in desired location. Mark position of **3 off** through holes which correspond to the cup hooks.

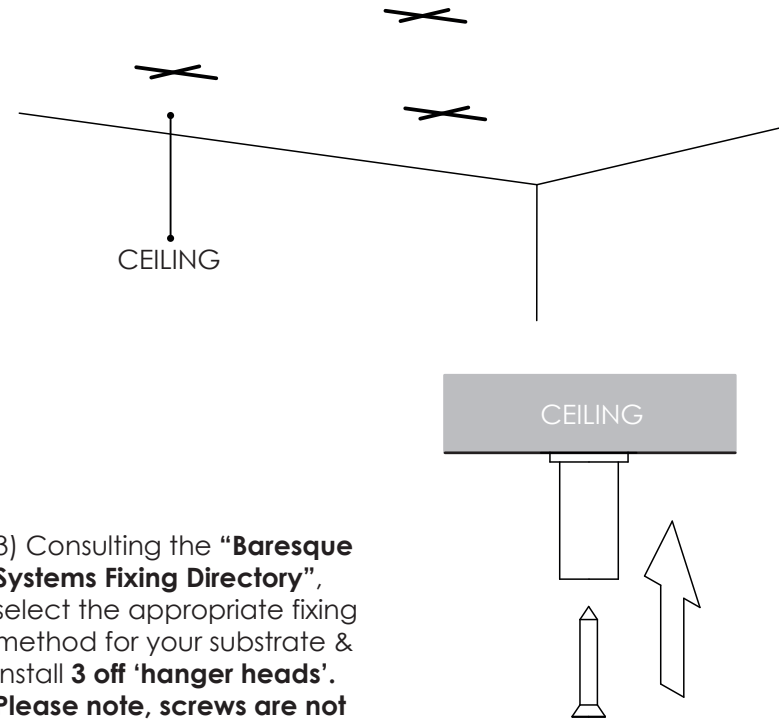

STEP 2 & 3

3) Consulting the “**Baresque Systems Fixing Directory**”, select the appropriate fixing method for your substrate & install **3 off** ‘hanger heads’. **Please note, screws are not supplied.**

CEILING SHAPES LARGE SUSPENSION GUIDE

4) Feed swaged wire through tip of 'wire adjuster' (as shown). Push button (shown in grey) to adjust wire length. Release the button to lock in place.

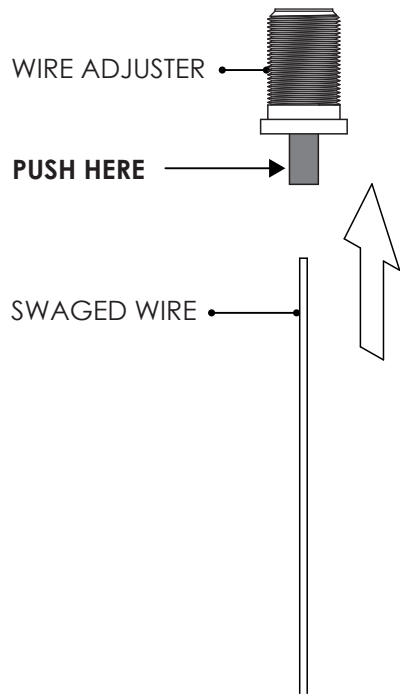

5) Feed swaged wire through hole in the side of 'hanger head'. Screw 'wire adjuster' into 'hanger head', then adjust wires so they finish at approx. the same length.

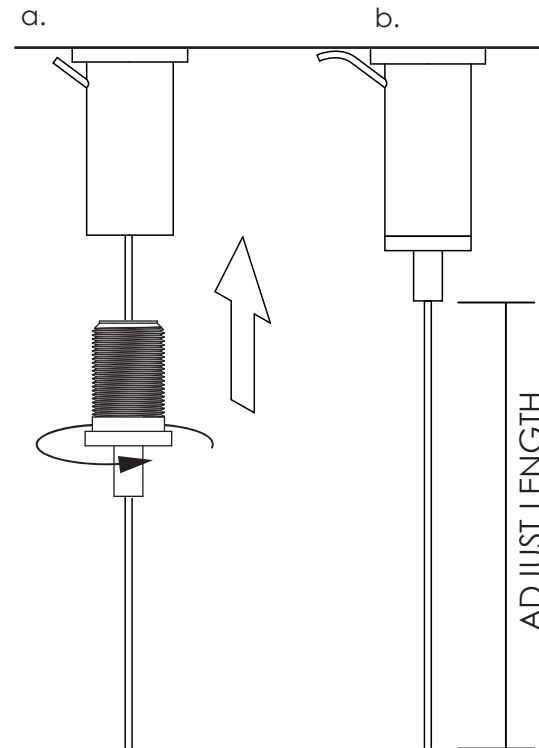

STEP 4 & 5

6) Suspend ceiling shape by looping cup hooks through swaged wire.

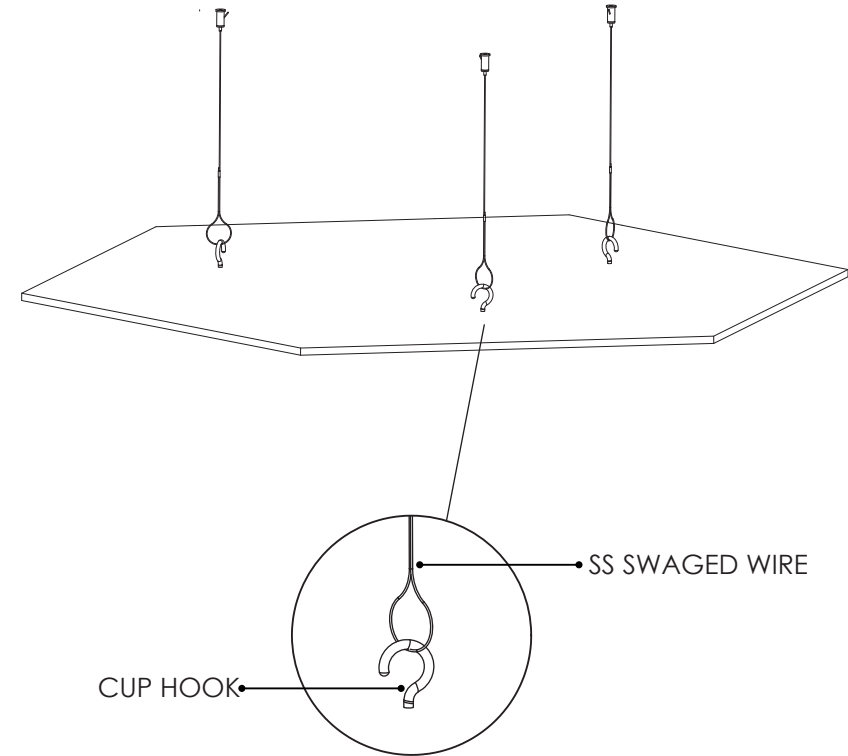

STEP 6

CEILING SHAPES SMALL INSTALL GUIDE

CEILING SHAPES SMALL SUSPENSION GUIDE

6) Re-adjust wire length as explained in STEP 5 until ceiling shape hangs level. Trim excess wire for a neat finish.

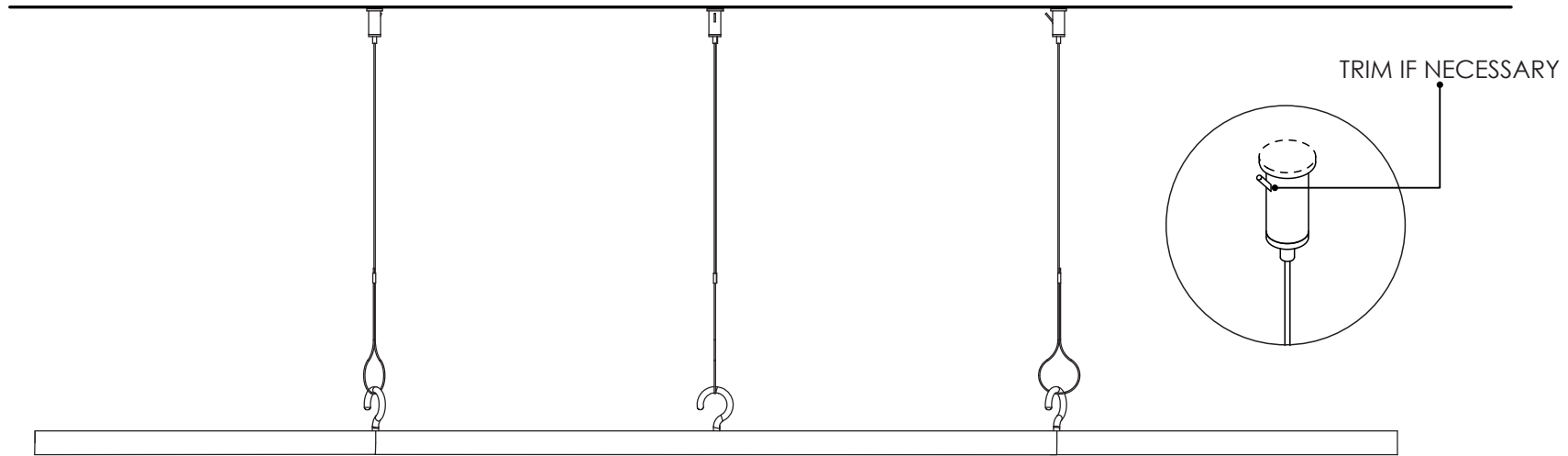

STEP 6

CEILING SHAPES SMALL INSTALL GUIDE

*Please note, above linework is representative only.
Your ceiling shape may not be depicted.

CEILING SHAPES SMALL PARTS

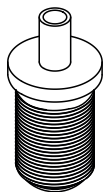

WIRE ADJUSTER
3 OFF

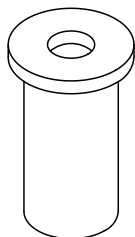

HANGER HEAD
3 OFF



CUP HOOK
3 OFF

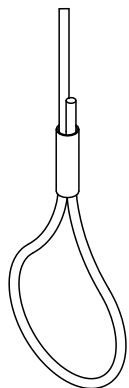

SWAGED WIRE
3 OFF

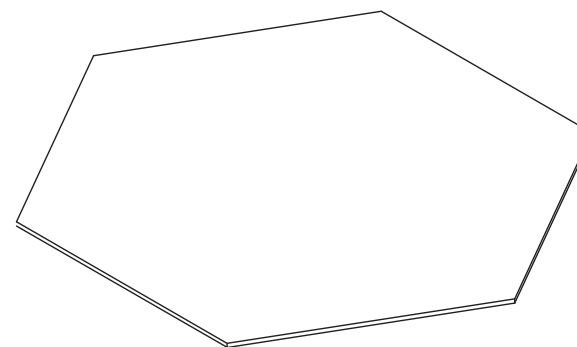

CEILING SHAPE
1 OFF

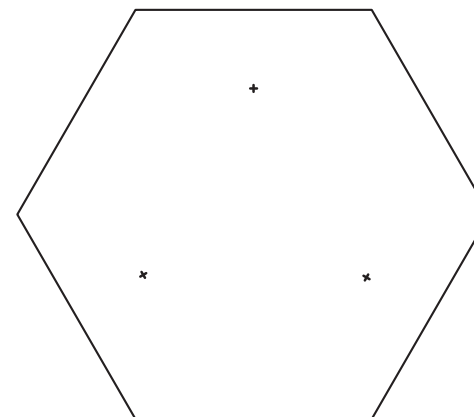

CEILING TEMPLATE
1 OFF

CEILING SHAPES SMALL INSTALL GUIDE

CEILING SHAPES SMALL
SHAPE OPTIONS

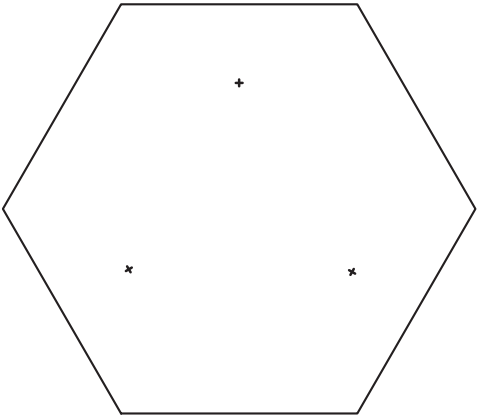

HEXAGON

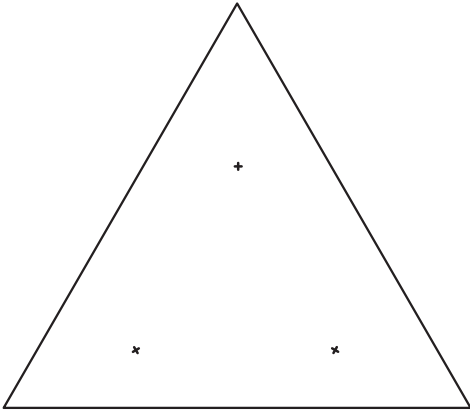

TRIANGLE

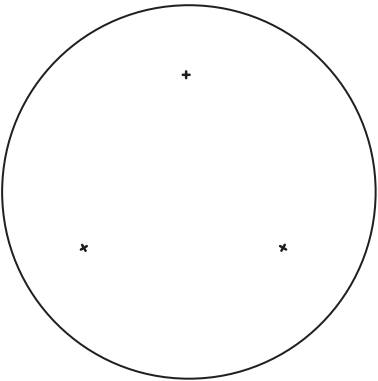

CIRCLE

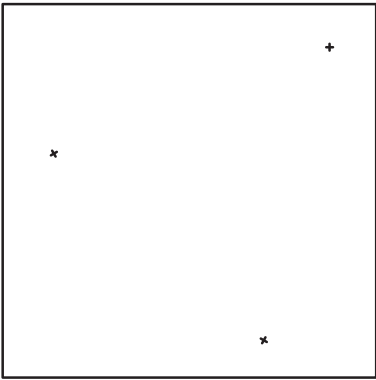

SQUARE

CEILING SHAPES SMALL
INSTALL GUIDE

*Please note, above linework is representative only.
Your ceiling shape may not be depicted.