

- Y-hook Cable hangers: ...6
- Wire Clamps:5
- Mesh:1
- Quills:219

Mesh Baffle - Random

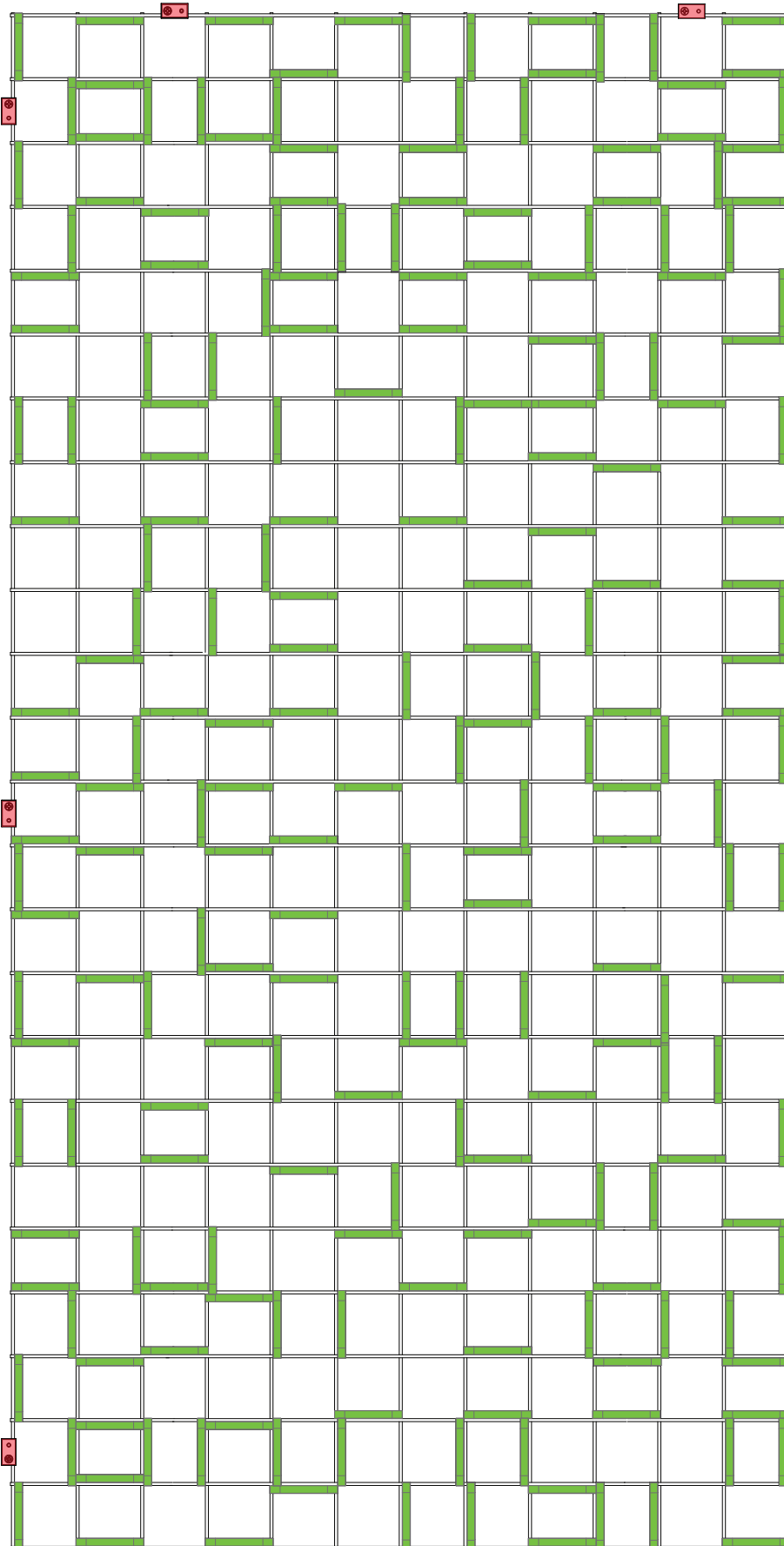

PARTS AND HARDWARE

FOR A TYPICAL ASSEMBLY

Mesh

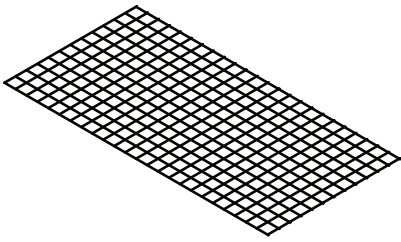

Cable

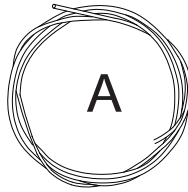

Y-hook gripper

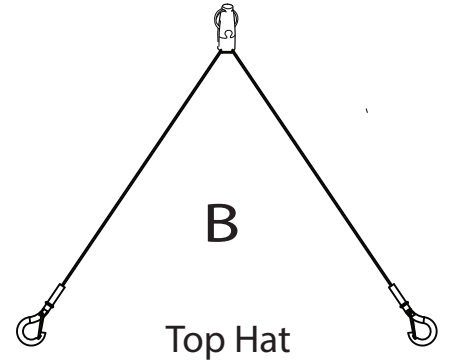

Wire Clamp

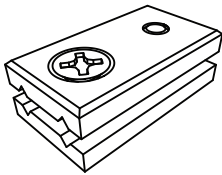

Quill

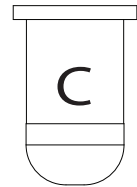
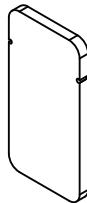

YOU WILL NEED

FOR A TYPICAL ASSEMBLY

LASER LEVEL

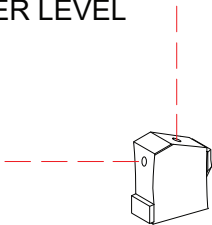

Marker pen



TYPE MEASURE

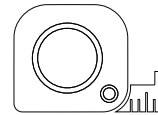

DRILL

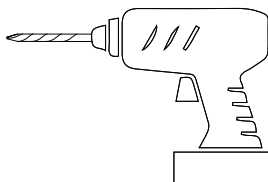

10 GAUGE SCREW

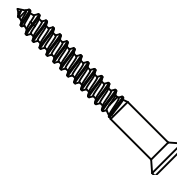



ZINTRA MESH BAFFLES

Random- Y-hook locations

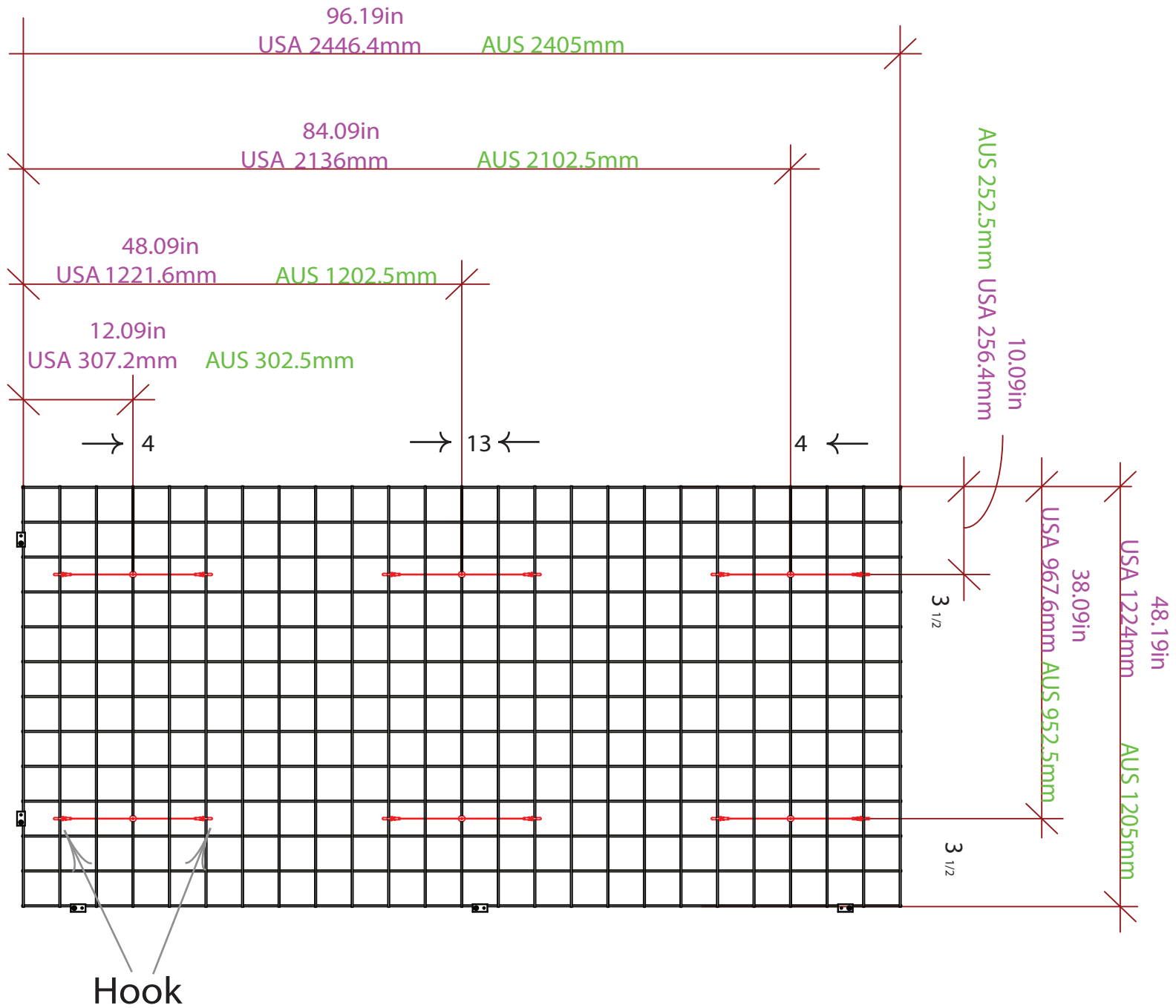

1

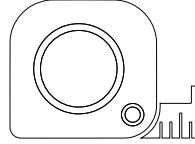

Determine the dimensions required from ceiling to underside of the quills by subtracting finished install height from the ceiling height. Place a mark at this dimension on the cable.
This will serve as a reference point to make leveling easier

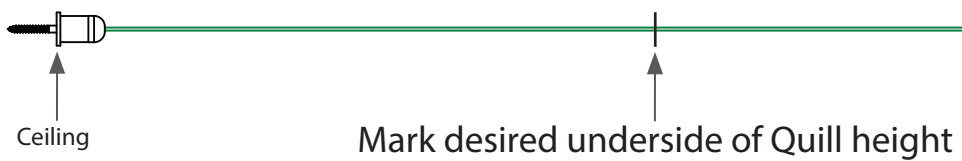

2

Pre Assembly the Y-hook cable hanger sets by threading cable (A) through the top hat (C).
Then by Sliding the y-hook gripper (B) up cable (A) until it reaches your reference mark from Step 1.

Note: this is only a temporary location to aid with leveling off.

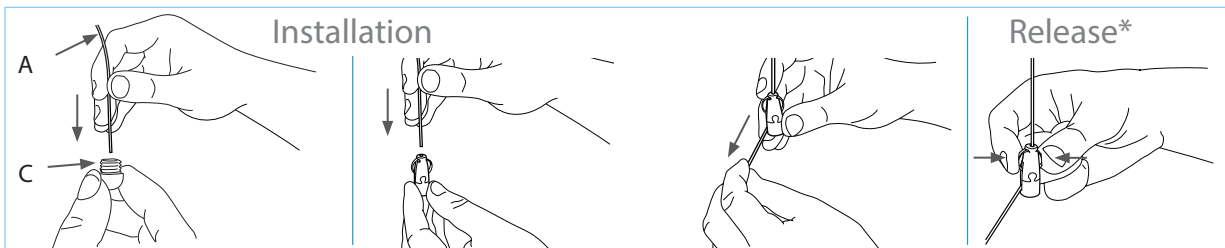

* When releasing: 1. Remove load, 2. Squeeze wings, 3. Raise or lower on cable

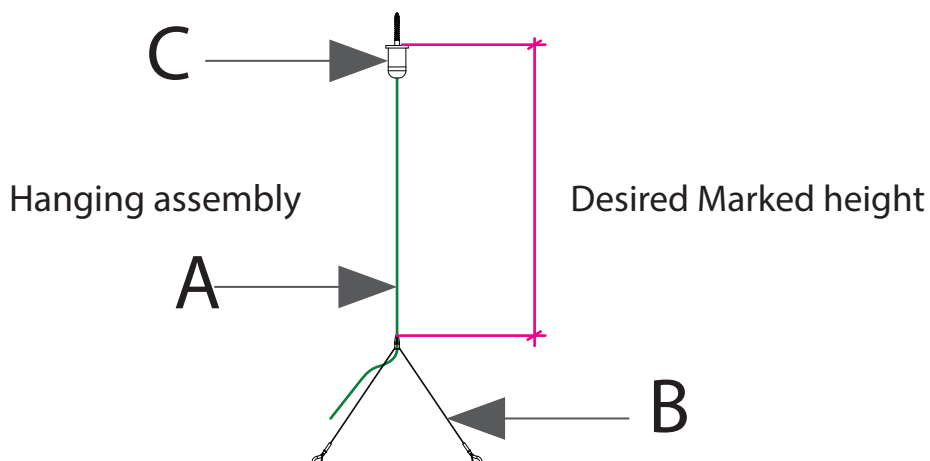

- 3** With your laser level, measure and mark fixing locations on the ceiling.
Tip: laying your mesh on the floor can help visualize where the fixing locations need to be. Drill as required.

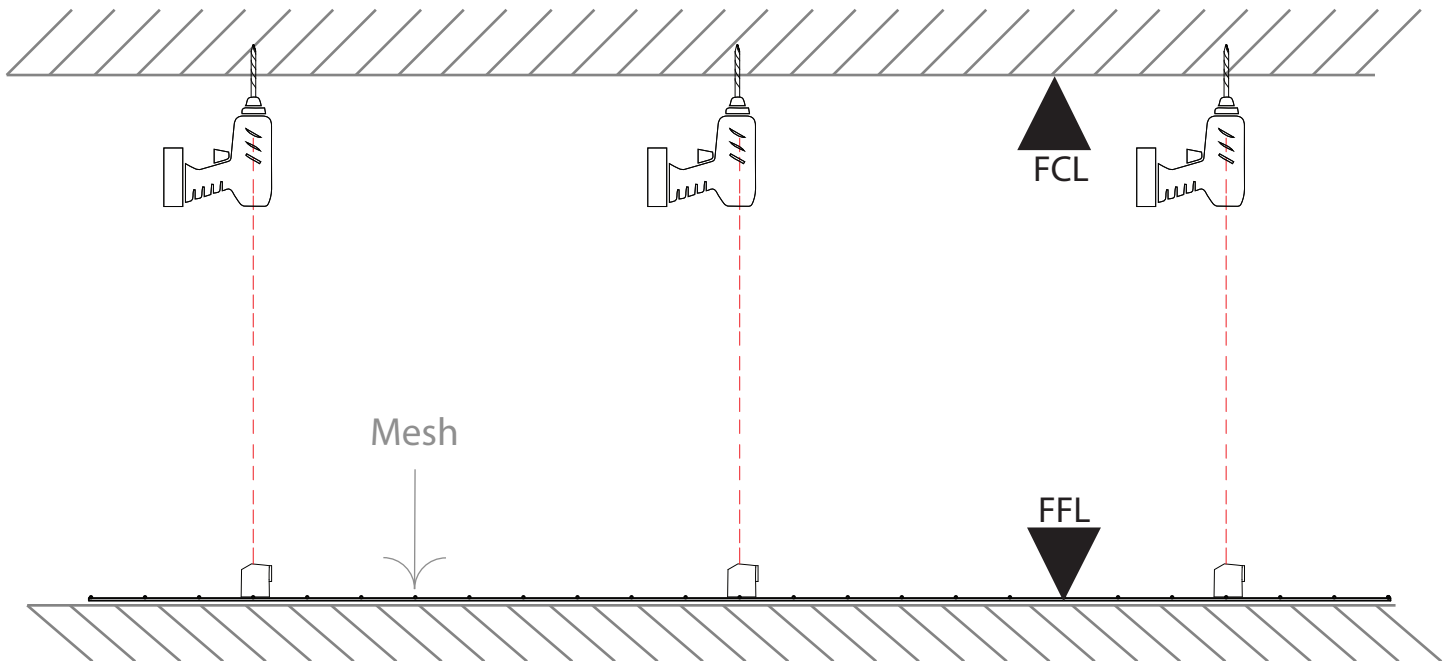

4

Fix Hanging assembly (A) to ceiling
as indicated below

If you have a concrete ceiling, use concrete plug anchors with
10gauge screws (not supplied).

For other ceiling types please consult hardware specialist for correct fastener type.

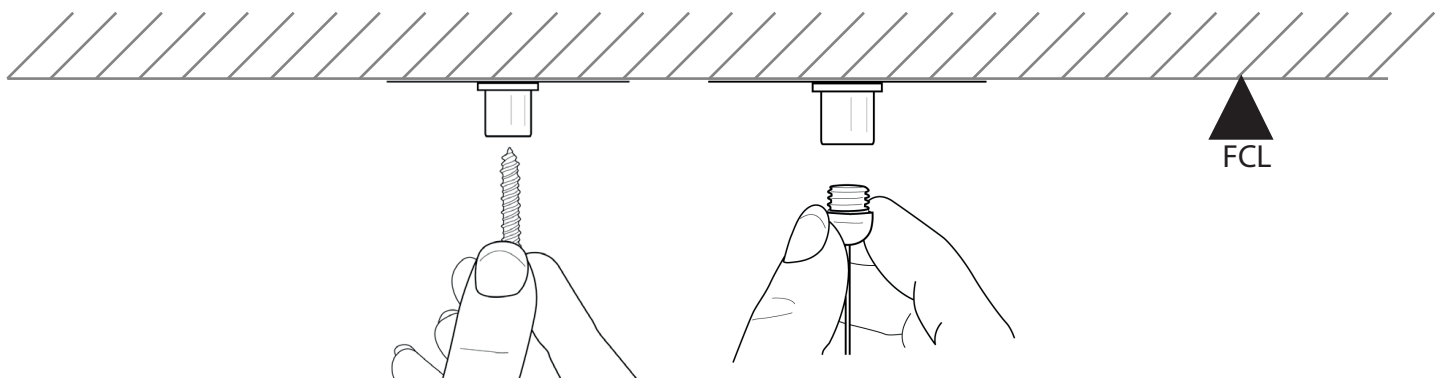

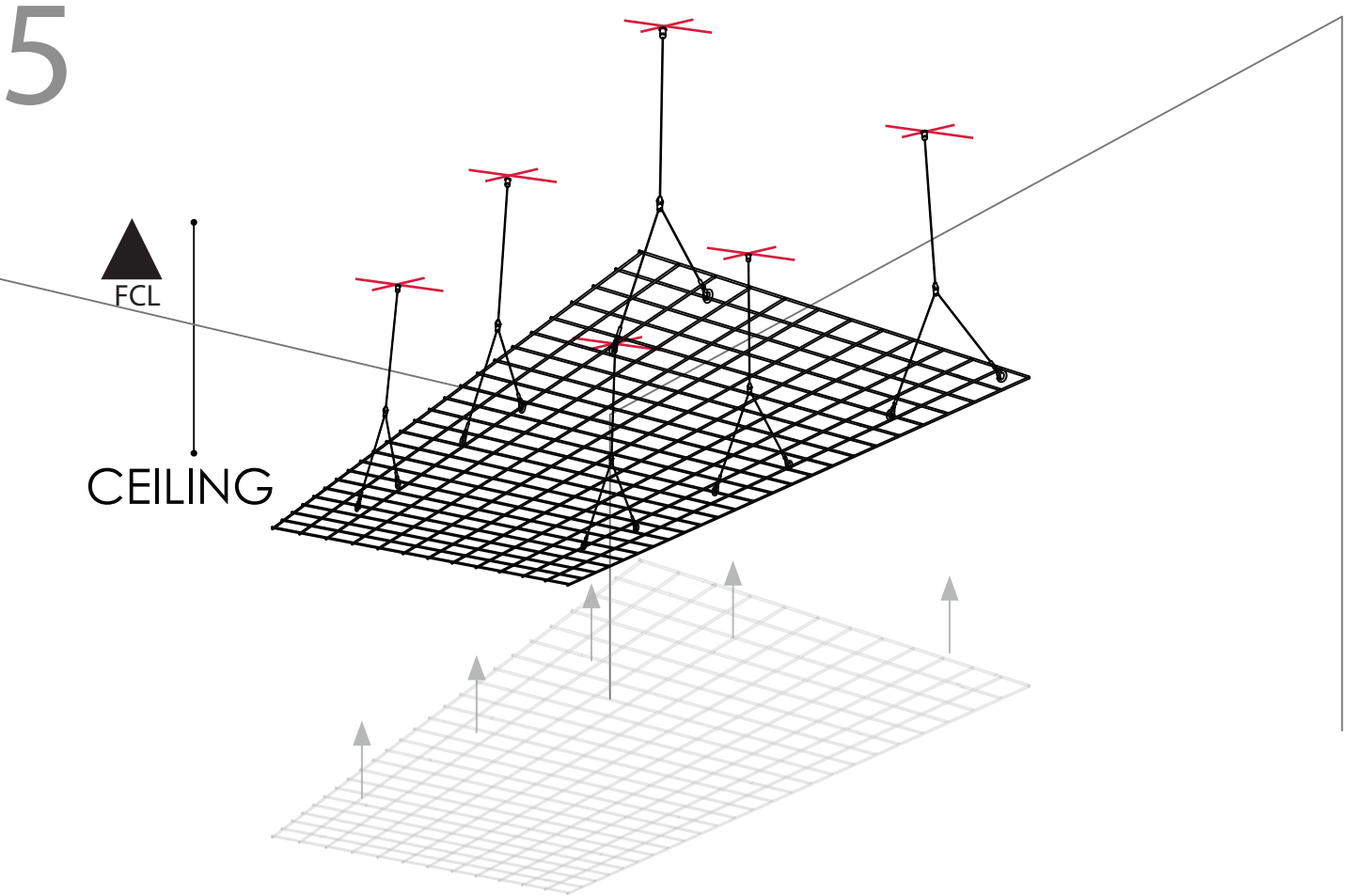

Hang the mesh onto the hooks. Follow the hook position from selected pattern

ZINTRA MESH BAFFLES

Mesh Baffle - Random

6

Set up a laser level at a convenient height below the mesh and measure at each hook location to ensure the Mesh is hanging level. ensure a tolerance of no more than 3mm (1/8") deviation across 2400mm (96") is met. For reference, the bottom edge of the quill measures 161mm (6.32") below the mesh. Once entire install is level, trim excess cable leaving a minimum 25mm (1") tail. Note: Use sharp wire cutters to avoid wire fraying.

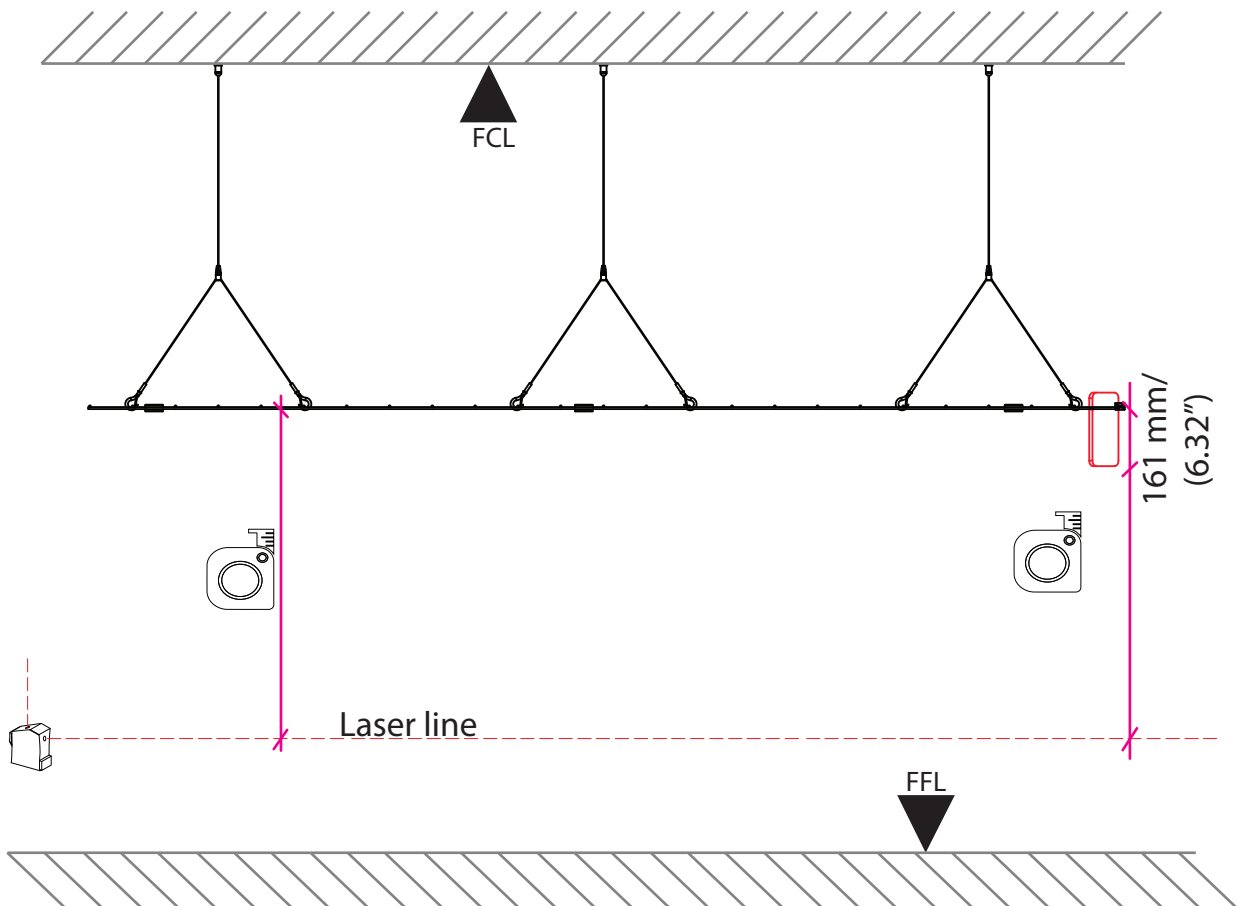

7

Level the mesh by adjusting the height of hanging assembly (B). To adjust, squeeze the clamp and pull on cable or lift the clamp block. release to lock in place.

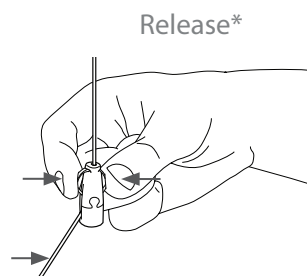

- 8** Following the Quill pattern layout diagram,
fit Quills into mesh by inserting and rotating to lock quills into place.
Slide the quill to either side of the opening as per Quill pattern layout diagram

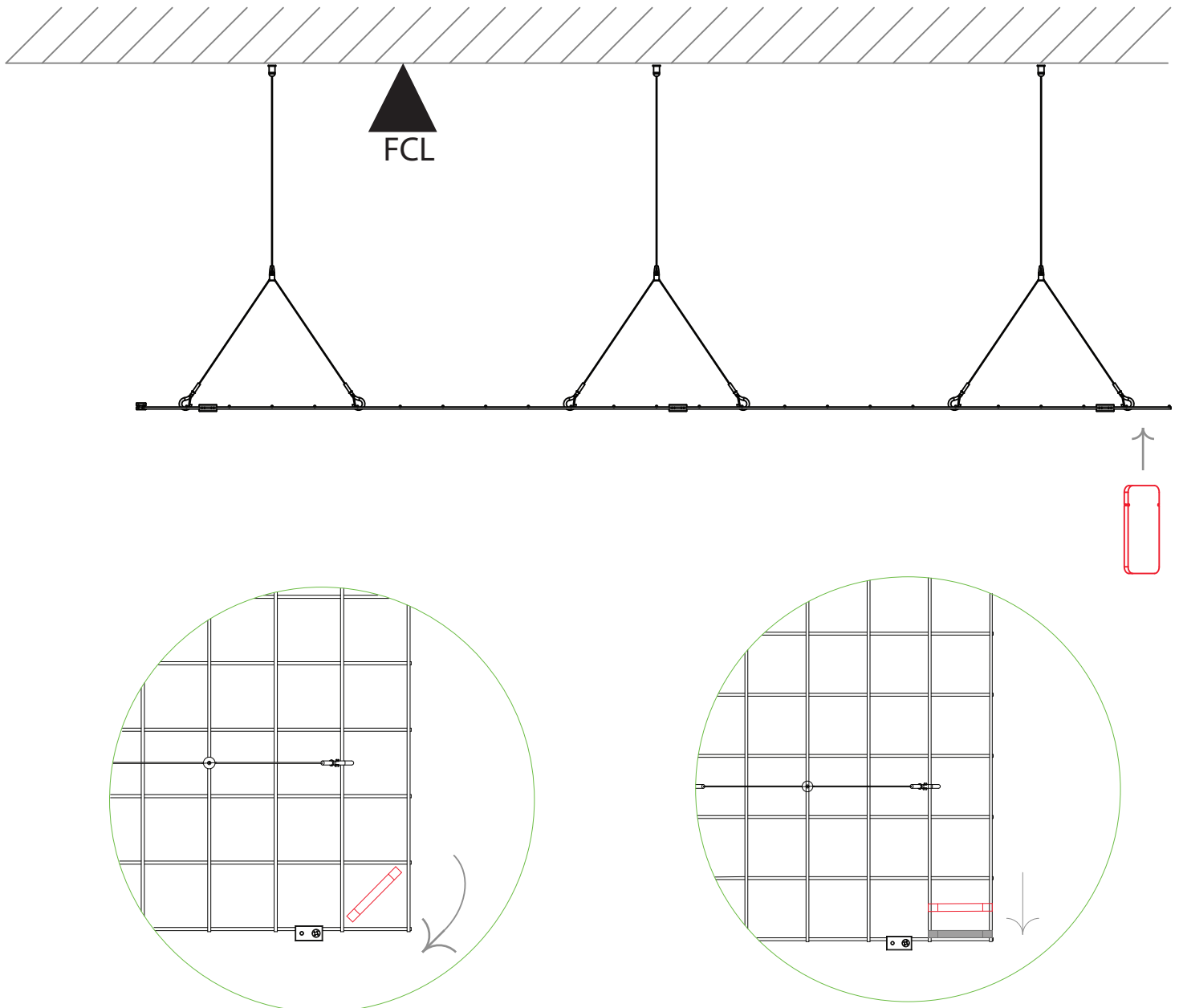

ZINTRA MESH BAFFLES

Mesh Baffle - Random

9 To join mesh baffle sets together, use the provided wire rope clamps.

We recommend:

- 2 Equally clamps on the short side
- 3 Equally spaced clamps on the long side
- For best results fix close to ends of mesh panels

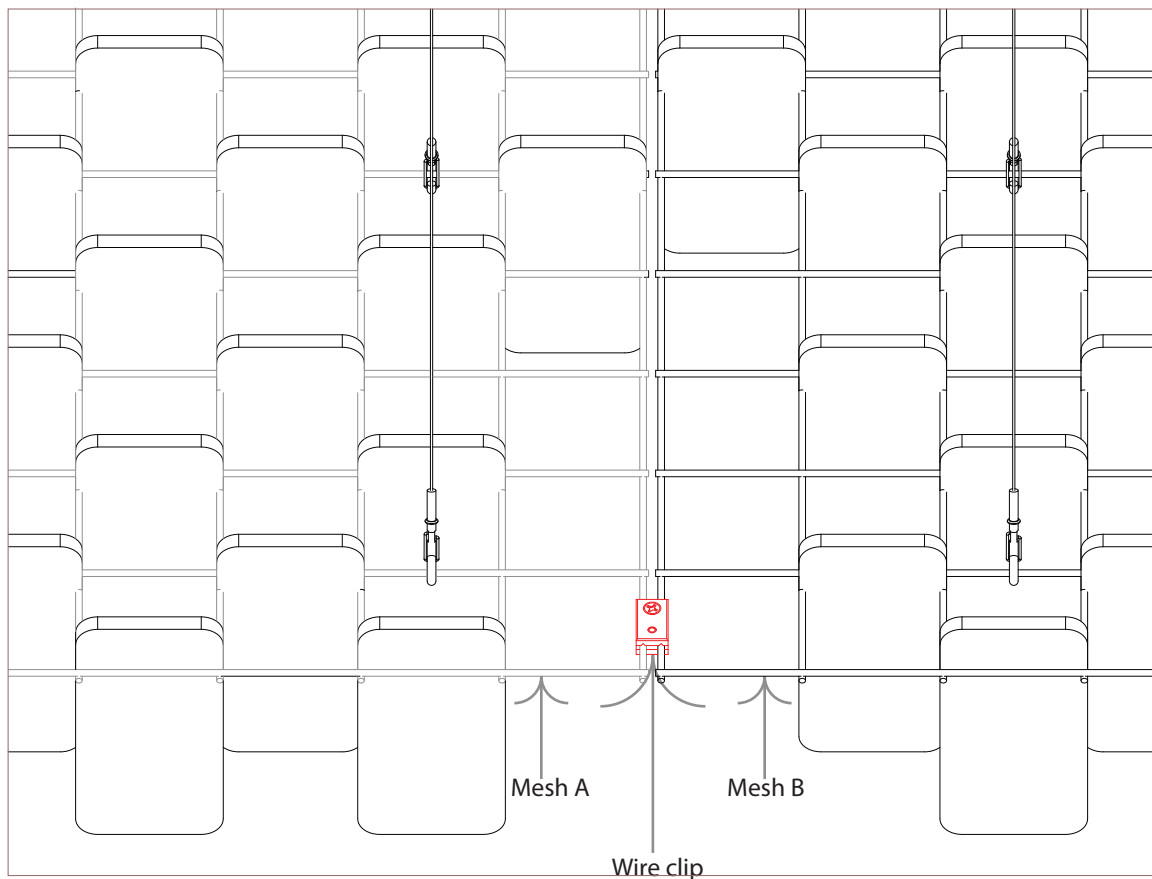

Single system

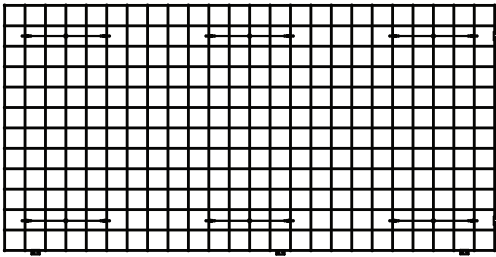

Double system long side

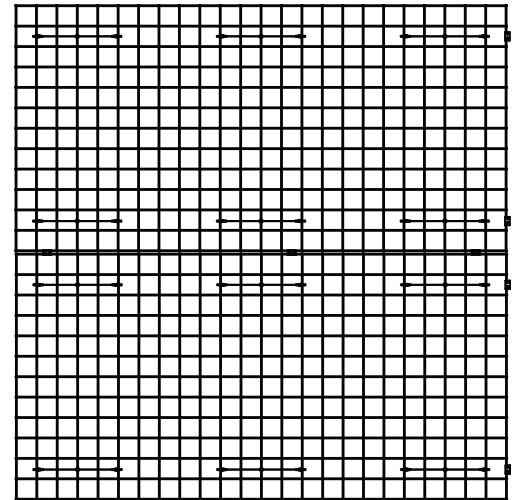

Double system short side

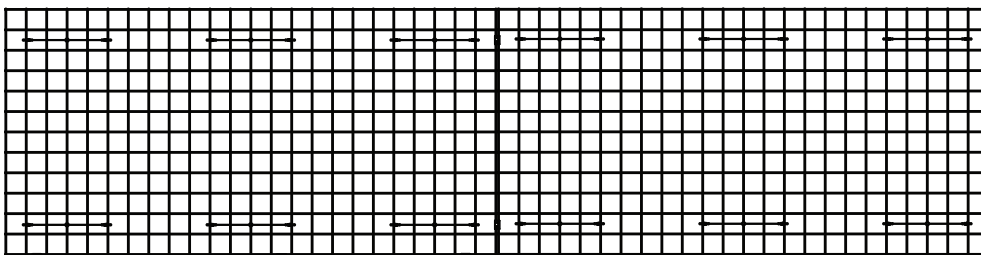

Triple + system

