

Kit Contents:

12 x 3M Adhesive Dual Lock Tab (2"x1")

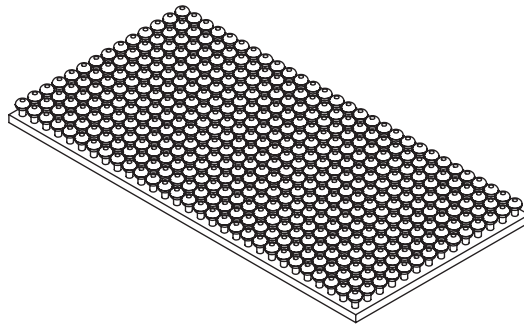

12 x 3M Command™ Adhesive Large Picture Hanging Strip

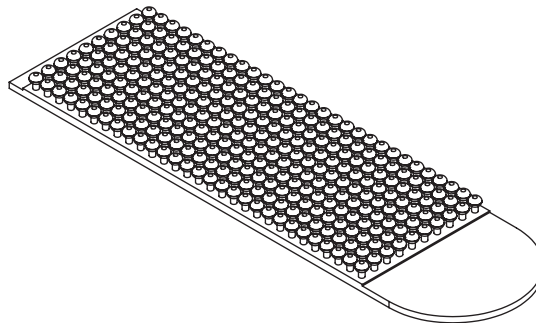

Total number of kits provided as required by P.O.

Step One:

Apply 2"x1" Dual Lock Tab to back of Zintra by removing protective film.

Fix according to recommended fixing patterns below.

Press firmly on entire surface area of adhesive tab for 3-5 seconds to secure bond.

For box tiles fix to face of corner support.

For full Zintra sheets and panels the recommended maximum distance between fixing points is 24"
Increasing the number of fixings is recommended to reduce "oil-canning" effect.

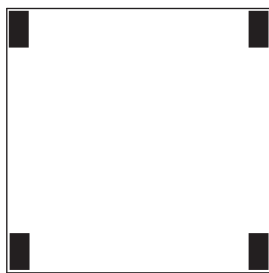

16x16in.



12x24in.



6x36in.

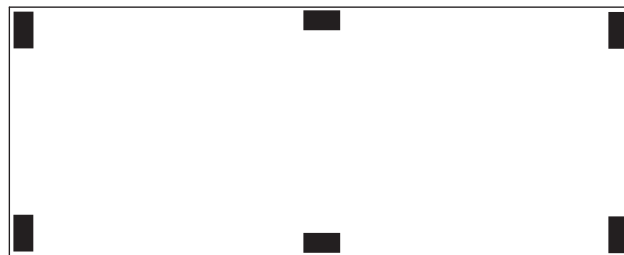

15x36in.

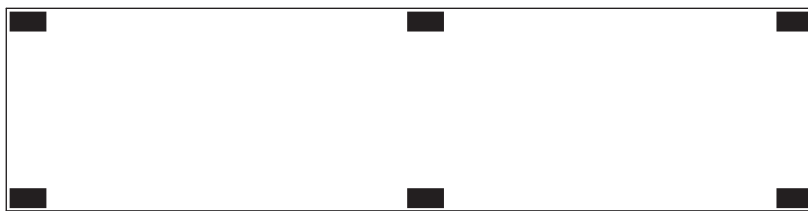

12x48in.

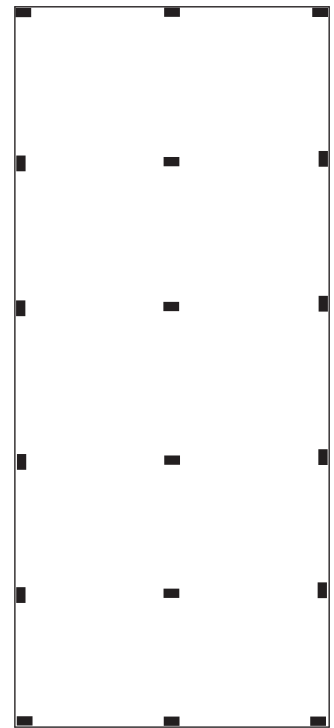

Full Sheet - 48x110in.

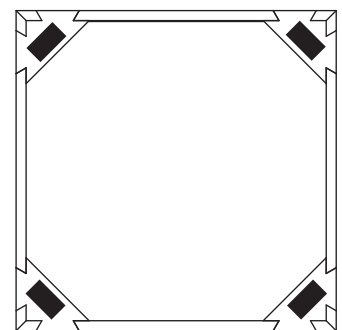

Box Tile - 16x16in.

Step Two:

Apply Command™ Adhesive Large Picture Hanging Strips to Dual Lock tabs on Zintra product.

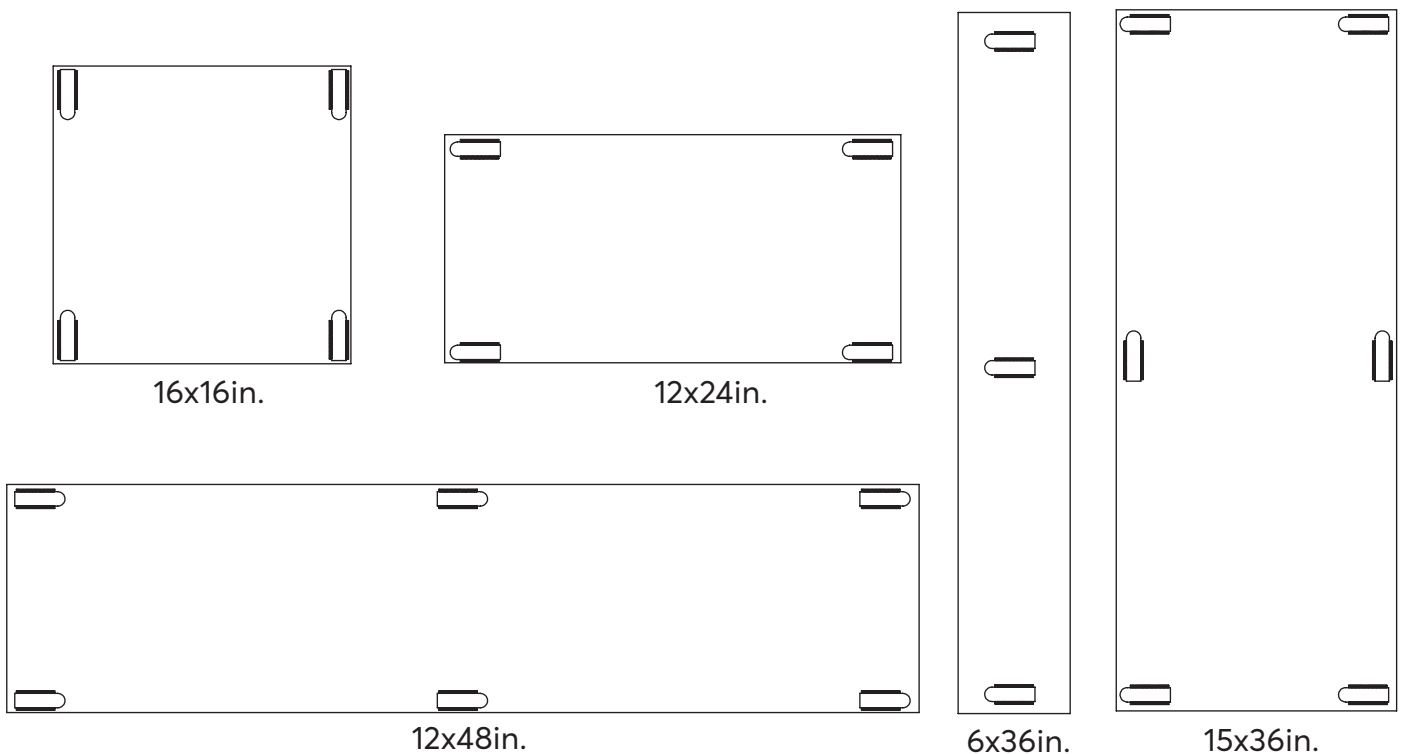

Step Three:

Remove protective film from Command™ strip and apply tile or sheet to wall.

Make sure to apply a firm pressure at fixing points to ensure a secure bond to wall.

If tile or sheet needs realignment, apply at least 30 seconds of pressure before removing tile to ensure the wall strip stays on the wall and the bond is broken at the dual lock allowing for repositioning or rotating of tiles.

For more information on how to use Command™ adhesive picture hanging strips, and to check whether this product suits your application go to [command.com/howtouse](https://www.command.com/howtouse).