

rolly toys Kundendienst Deutschland:

Tel: +49 (0) 95 68 / 856-142
Fax: +49 (0) 95 68 / 856-183
e-mail: service@rollytoys.de

2021/05

508.000.800.00

WARNING

- CHOKING HAZARD - Small parts, Danger of being swallowed. Contains small parts in non assembled state. Must be assembled by adults.
- Toy is not suitable to carry children.
- If toy is defective stop using it, repairs may only be carried out by adults.
- Adult supervision required.
- Never use near steps, slopes, driveways, hills, roadways, alleys or swimming pool areas.
- Always wear shoes.
- Conforms to the requirements of ASTM Standard Consumer Safety Specification on Toy Safety, F 963.

AVERTISSEMENT

- RISQUE D'ÉTOUFFEMENT - Petites pièces. Risque d'ingestion. Contient des petites pièces à l'état non assemblé. Doit être assemblé par un adulte.
- Le jouet ne convient pas au transport des enfants.
- Si le jouet est défectueux, cessez de l'utiliser. Toute réparation ne doit être effectuée que par un adulte.
- Surveillance d'un adulte requise.
- Ne jamais utiliser à proximité des marches, des pentes, des allées, des collines, des routes, des allées ou des piscines.
- Portez toujours des chaussures.
- Conforme aux exigences de la norme internationale ASTM Standard Consumer Safety Specification on Toy Safety, F 963.

<input type="checkbox"/>	rolly Dreiradtraktoren	05 ●●●
<input type="checkbox"/>	rollyMinitrac	13 ●●●
<input type="checkbox"/>	rollyKid	01 ●●● / 02 ●●●
<input checked="" type="checkbox"/>	rollyJunior	80 ●●● / 81 ●●●
<input checked="" type="checkbox"/>	rollyFarmtrac	60 ●●● / 61 ●●●
<input checked="" type="checkbox"/>	rollyFarmtrac Classic	03 ●●● / 04 ●●●
<input checked="" type="checkbox"/>	rollyFarmtrac Premium	70 ●●● / 71 ●●●
<input checked="" type="checkbox"/>	rollyX-Trac	03 ●●● / 04 ●●●
<input checked="" type="checkbox"/>	rollyTruck (Unimog)	03 ●●●

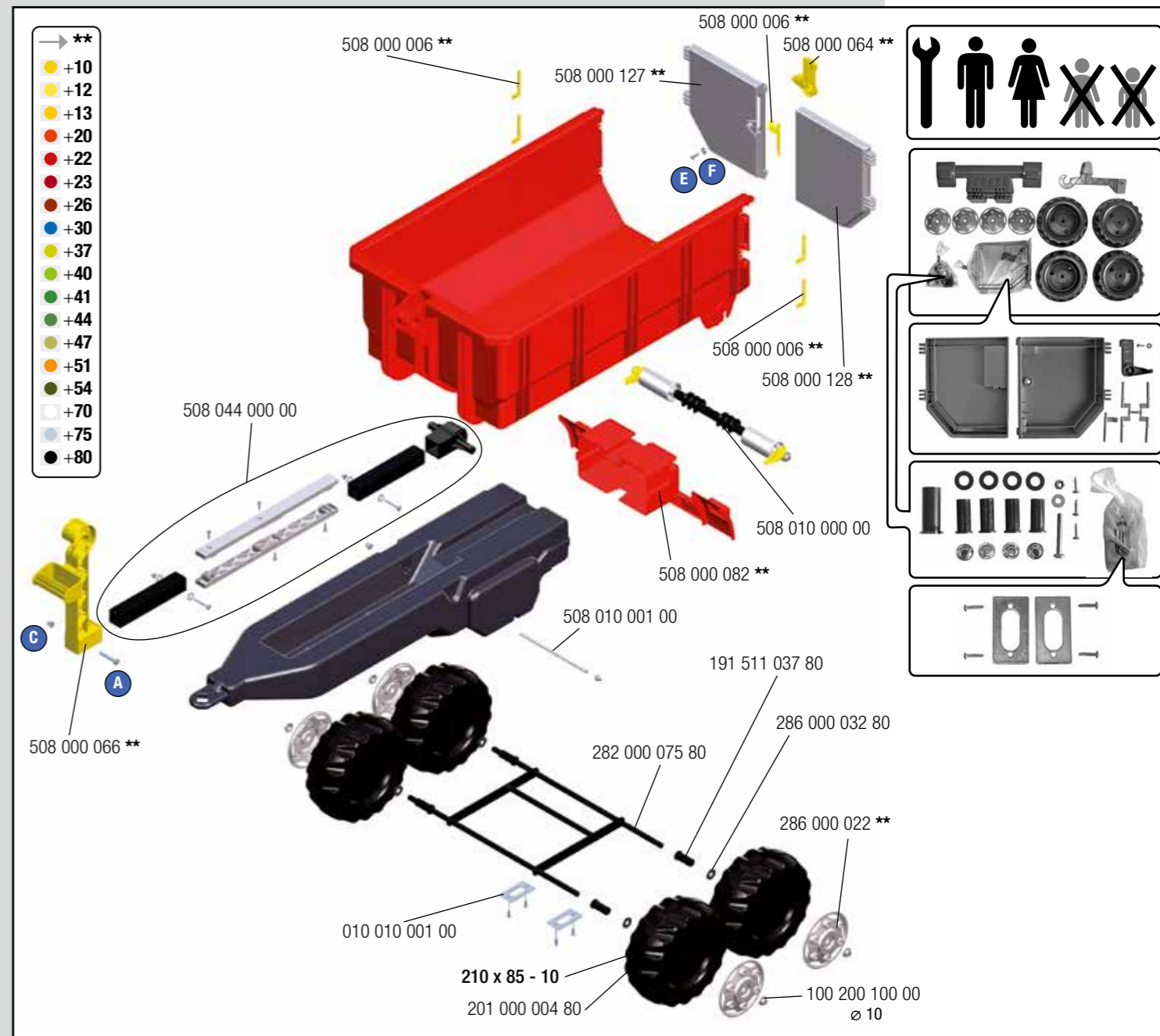

WARNING:

CHOKING HAZARD – Small parts.
Not for children under 3 years.

---NORTH & SOUTH AMERICA only---

180 days warranty

From the date of purchase + guaranteed spare part service
The warranty does not cover damages caused by improper use or neglect



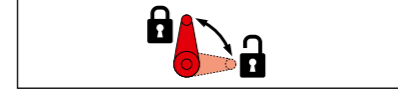
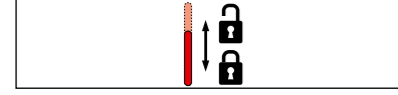
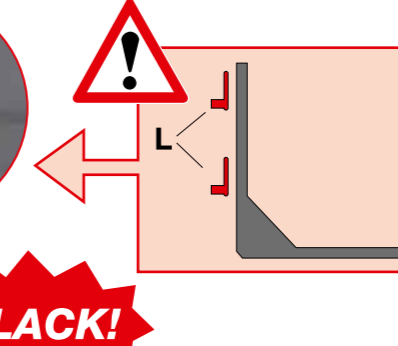
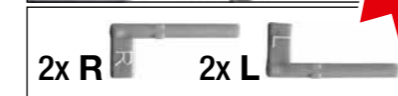
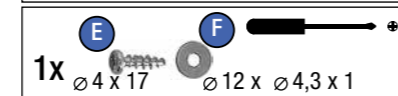
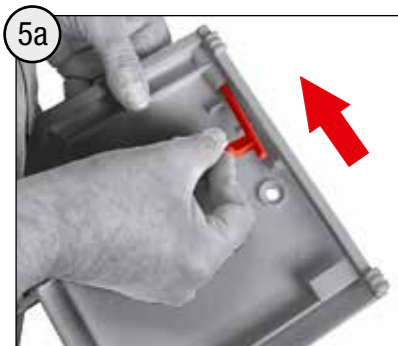
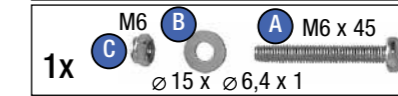
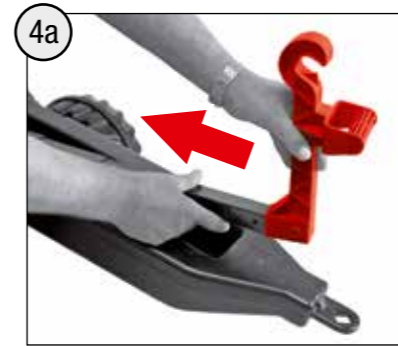
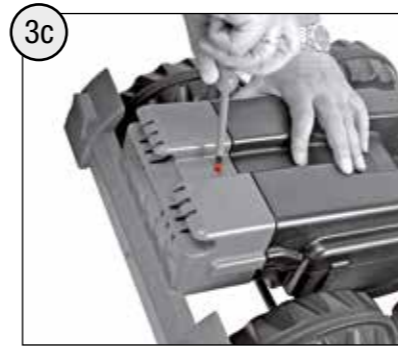
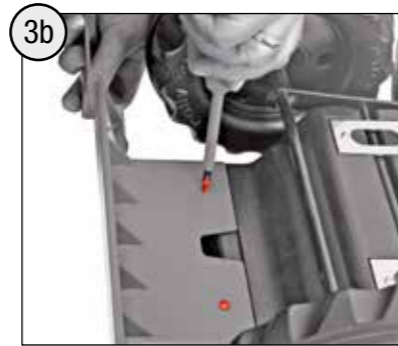
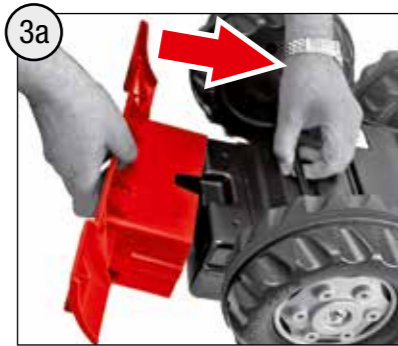
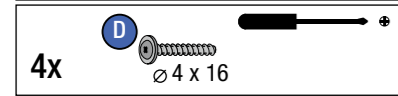
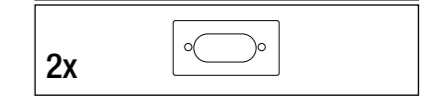
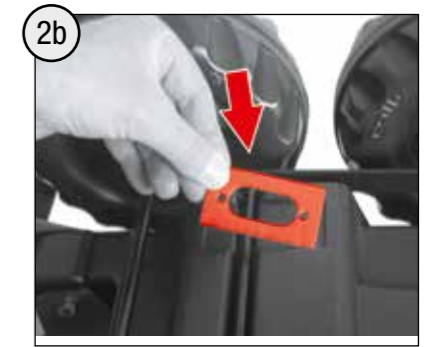
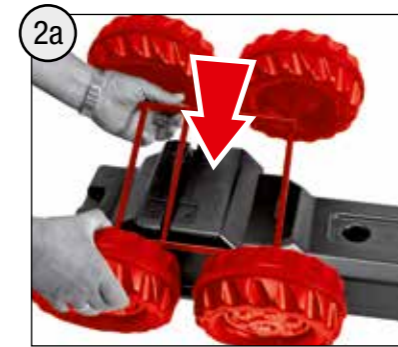
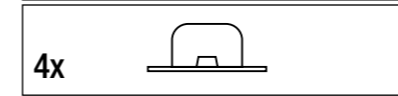
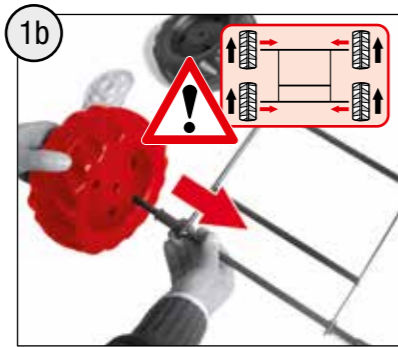
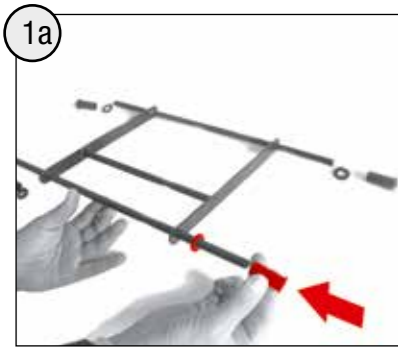

Parts list for steps 5e and 5f:

- A: 1x M6 x 45 screw
- B: 1x ø 15 x ø 6,4 x 1 washer
- C: 1x M6 nut
- D: 4x ø 4 x 16 screw
- E: 4x ø 4 x 17 screw
- F: 1x ø 12 x ø 4,3 x 1 washer

Scale: 0 to 50 mm (metrisch • metric)