

# Luftbereifung

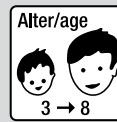

**rolly toys Kundendienst Deutschland:**

Tel: +49 (0) 95 68 / 856-142

Fax: +49 (0) 95 68 / 856-183

e-mail: service@rollytoys.de



2021/05

**984.000.800.00**

**WARNING:**  
**CHOKING HAZARD – Small parts.**  
 Not for children under 3 years.

**A1**  
 0-3

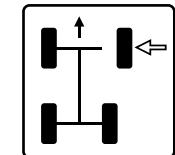
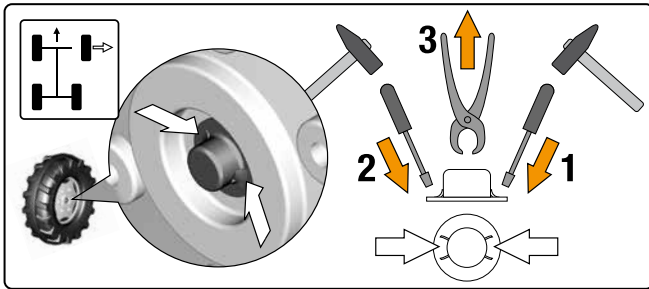

- 001 002 000 12
- 001 002 000 20
- 001 002 000 70
- 001 002 000 75

- 001 003 000 12
- 001 003 000 20
- 001 003 000 70
- 001 003 000 75



**made in Germany**

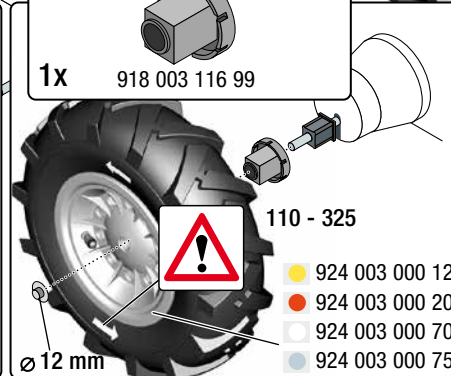
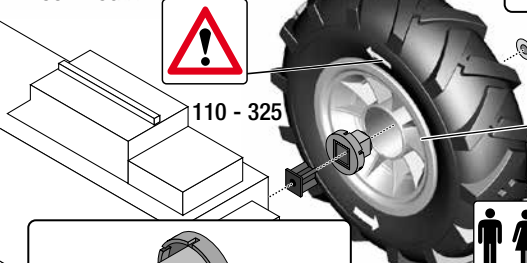
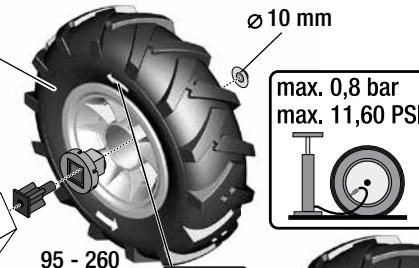
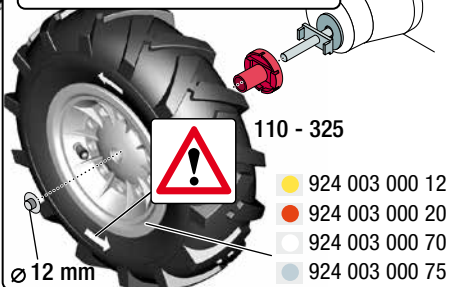

(BG) Предупреждение!	(LT) Įspėjimas!
(CZ) Varování!	(LV) Uzmanību!
(D) Achtung!	(M) Avvis!
(DK) Advarsel!	(MK) Внимание!
(E) Aviso!	(N) OBS!
(EST) Hoiatus!	(NL) Waarschuwing!
(F) Attention!	(P) Aviso!
(FIN) Varoitus!	(PL) Ostrożnie!
(GB) Warning!	(RO) Avertisment!
(GR) Προσοχή!	(RUS) Внимание!
(H) Figyelmeztetés!	(S) Varning!
(HR) Pažnja!	(SK) Varovanie!
(I) Avviso!	(SLO) Opozorilo!
(IRL) Rabhchán!	(TR) Dikkat!

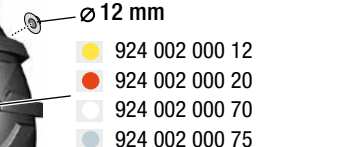
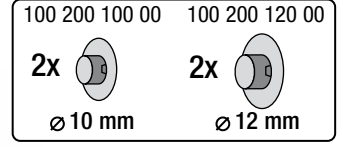
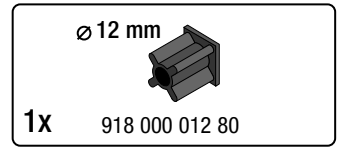
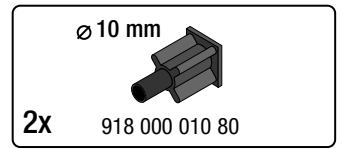

---NORTH & SOUTH AMERICA only---  
**180 days warranty**

From the date of purchase + guaranteed spare part service  
 The warranty does not cover damages caused by improper use or neglect

## WARNING

- CHOKING HAZARD: Small parts. Danger of being swallowed. Contains small parts in non assembled state. Must be assembled by adults.
- Adult supervision required.
- Never use near steps, slopes, driveways, hills, roadways, alleys or swimming pool areas.

- Always wear shoes.
- Never allow more than one rider.
- The use of protective gear and a safety helmet is highly recommended.
- Conforms to the requirements of ASTM Standard Consumer Safety Specification on Toy Safety, F 963
- Not suitable for children under 3 years.



**Franz Schneider GmbH & Co KG**  
 P.O.Box 1460  
 D-96459 - Neustadt bei Coburg - Germany  
 Tel.: +49 (0) 95 68 / 856-0  
 Fax.: +49 (0) 95 68 / 856-190  
 www.rollytoys.com

