

rolly[®] trac lader

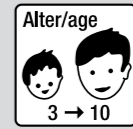

rolly toys Kundendienst Deutschland:
Tel: +49 (0) 95 68 / 856-142
Fax: +49 (0) 95 68 / 856-183
e-mail: service@rollytoys.de



2021/05

934.000.800.00

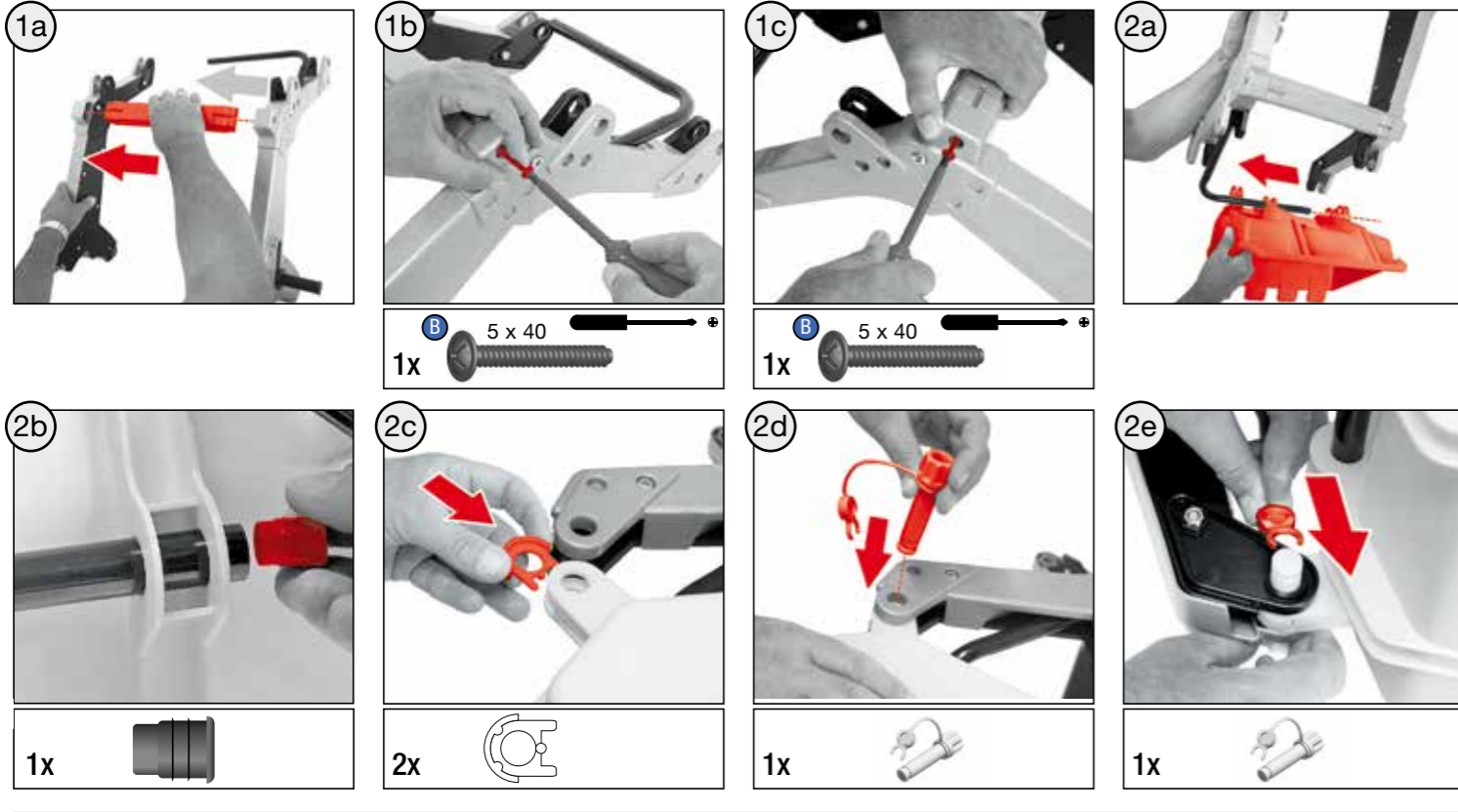

WARNING:
CHOKING HAZARD – Small parts.
Not for children under 3 years.

- CHOKING HAZARD - Small parts, Danger of being swallowed. Contains small parts in non assembled state. Must be assembled by adults.
- Toy is not suitable to carry children.
- If toy is defective stop using it, repairs may only be carried out by adults.
- Adult supervision required.
- Never use near steps, slopes, driveways, hills, roadways, alleys or swimming pool areas.
- Always wear shoes.
- Conforms to the requirements of ASTM Standard Consumer Safety Specification on Toy Safety, F 963.

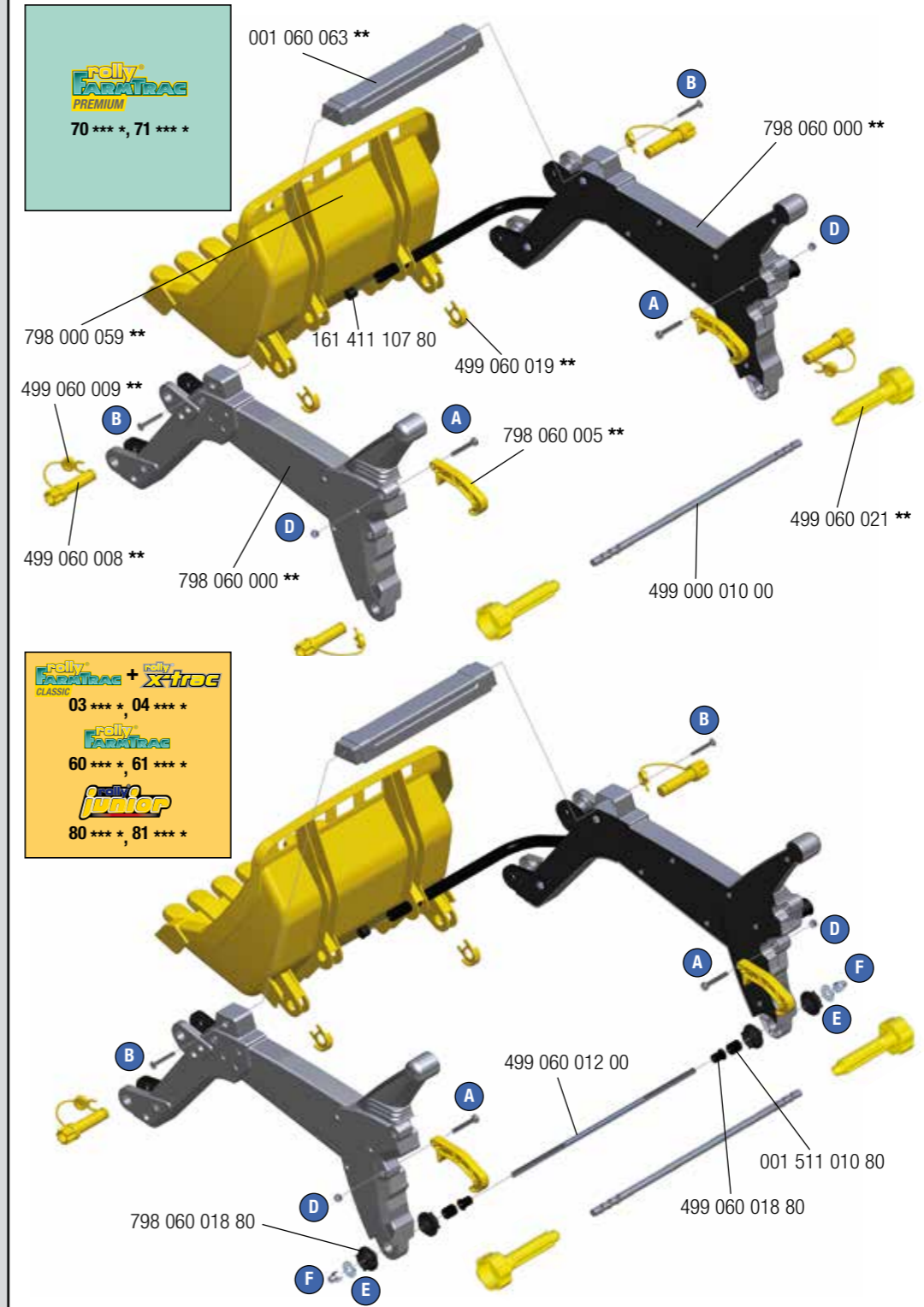
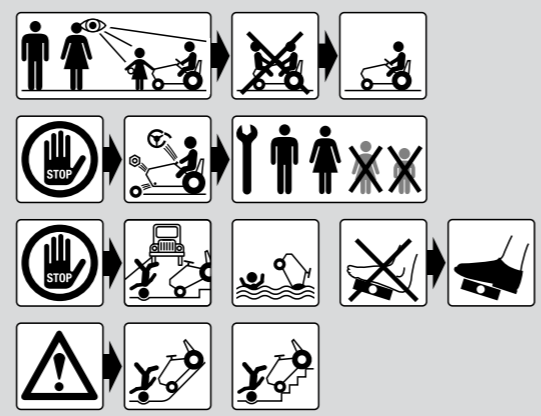

rolly FABRICATION CLASSIC + XTREME
03 *** , 04 ***
rolly FABRICATION
60 *** , 61 ***
rolly junior
80 *** , 81 ***

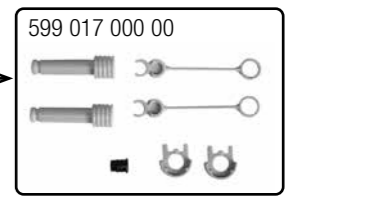
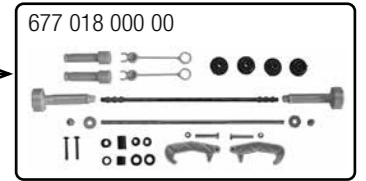

→ **	● +10	● +26	● +47
	● +12	● +30	● +51
	● +13	● +37	● +54
	● +20	● +40	● +70
	● +22	● +41	● +75
	● +23	● +44	● +80

--- NORTH & SOUTH AMERICA only ---
180 days warranty
From the date of purchase + guaranteed spare part service
The warranty does not cover damages caused by improper use or neglect

made in Germany

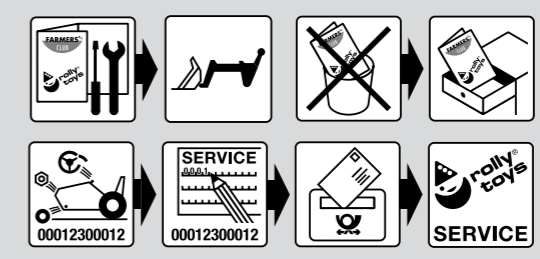

Franz Schneider GmbH & Co KG
P.O.Box 1460
D-96459 - Neustadt bei Coburg · Germany
Tel.: +49 (0) 95 68 / 856-0
Fax.: +49 (0) 95 68 / 856-190
www.rollytoys.com

rely[®]
FARATRAC
PREMIUM
70 *** , 71 ***
(A - I)

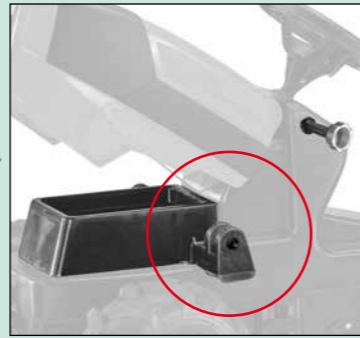
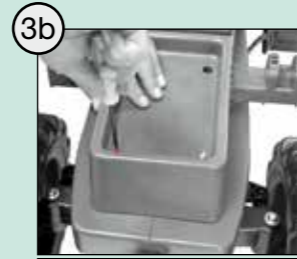
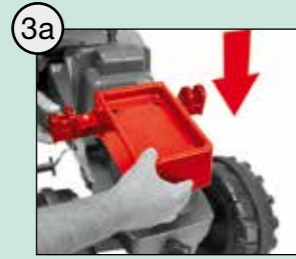

2x **B** 5 x 40
2x **C** 3 x 20

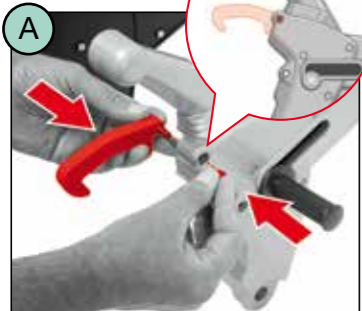

1x **A** M6 x 40
1x **D** M6

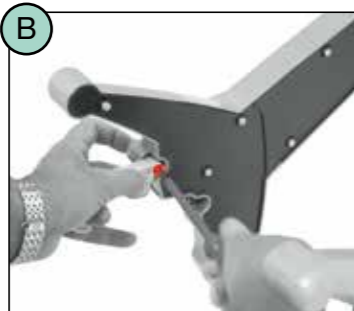

1x

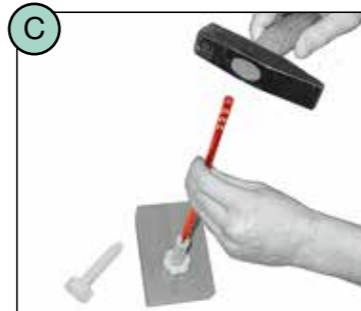

1x $\varnothing 8 \times 335\text{mm}$

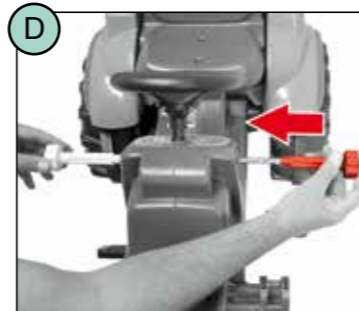

1x

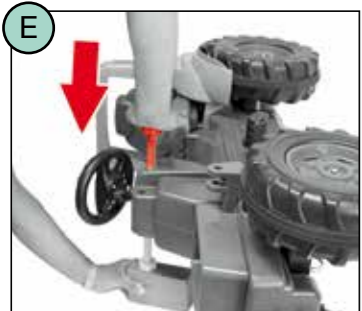

2x

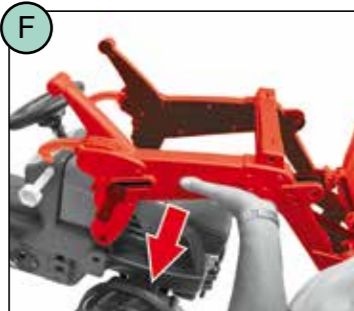

2x



2x

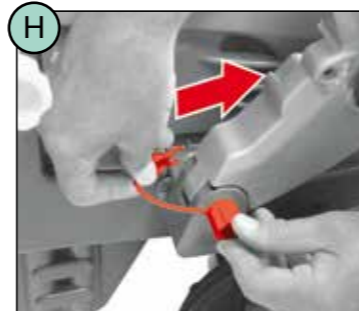

2x



KLACK!

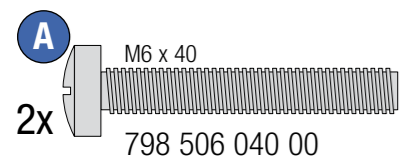

2x **A** M6 x 40
798 506 040 00

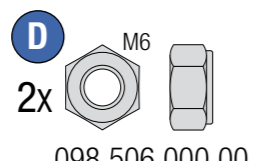

2x **D** M6
098 506 000 00

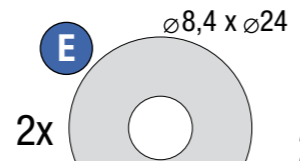

2x **E** $\varnothing 8,4 \times \varnothing 24$
902 184 000 00

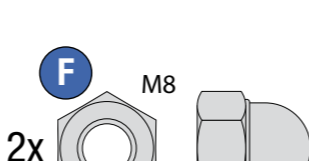

2x **F** M8
098 608 000 00

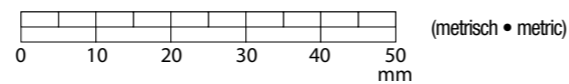

(metrisch • metric)

rely[®]
FARATRAC
CLASSIC
03 *** , 04 ***
rely[®]
FARATRAC
60 *** , 61 ***
rely[®]
junior
80 *** , 81 ***
(J - Z)

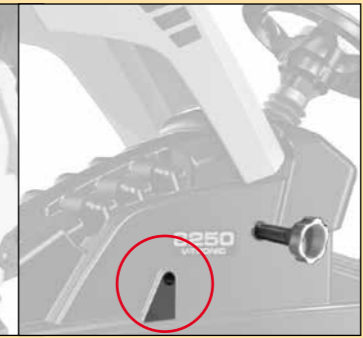
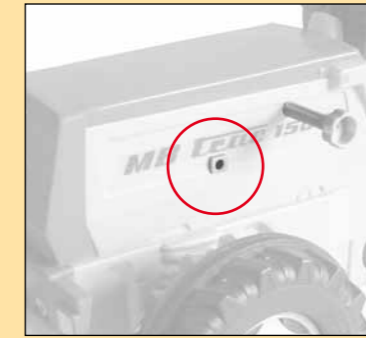

1x **A** M6 x 40
1x **D** M6

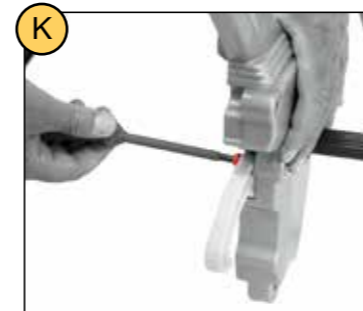

1x



1x $\varnothing 8 \times 335\text{mm}$

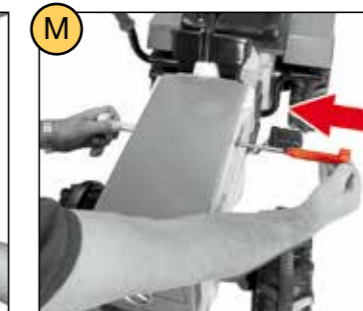

1x

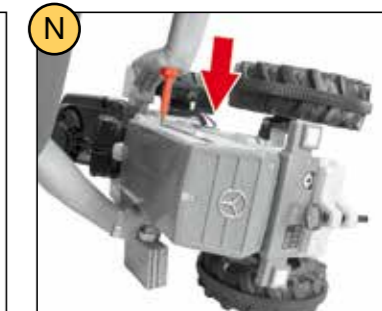

1x

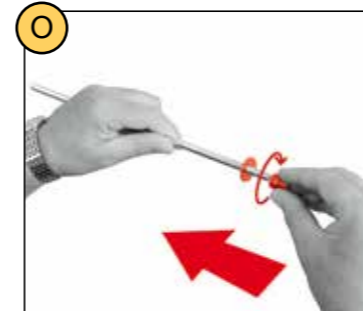

1x $\varnothing 8 \times 345\text{mm}$



2x $\varnothing 12 \times 16\text{mm}$

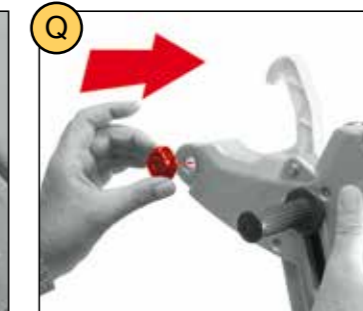

1x



1x

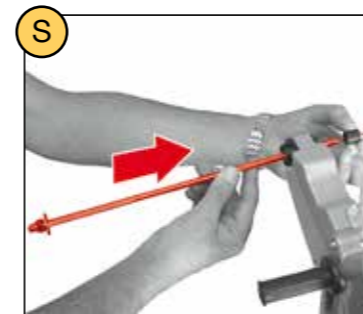

1x

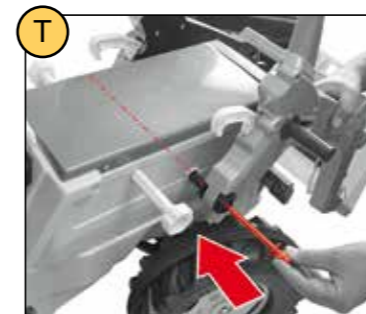

1x

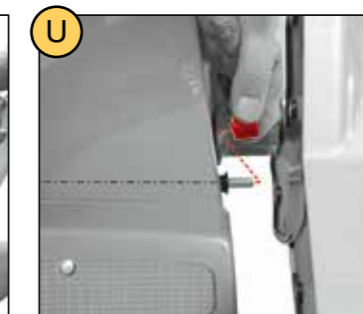

1x

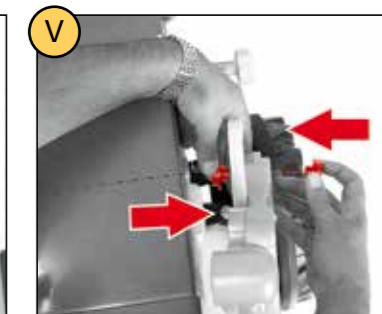

1x



1x **E** $\varnothing 8,4 \times \varnothing 24$

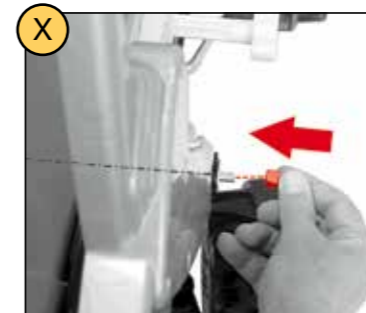

1x **F** M8



1x



KLACK!

