

RO*825X Kugelkupplung / Ball hitch

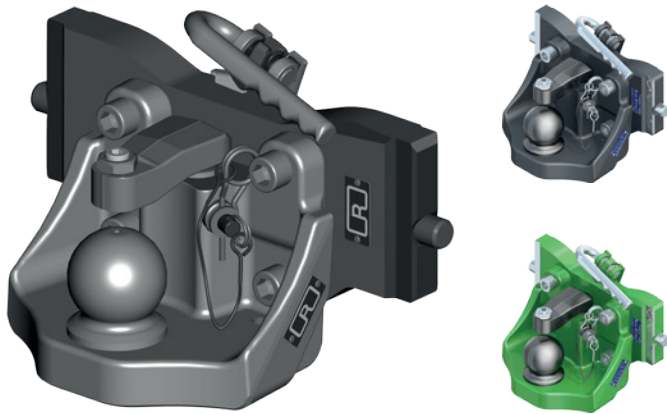

Vorteile auf einen Blick / Advantages at a glance

- DE** • Kugelkupplung mit Komforthöhenverstellung
- Kugel RO*825B auf Kupplungsträger RO*899D montiert
- EN** • Ball hitch with comfort height adjustment
- Ball RO*825B mounted on support RO*899D

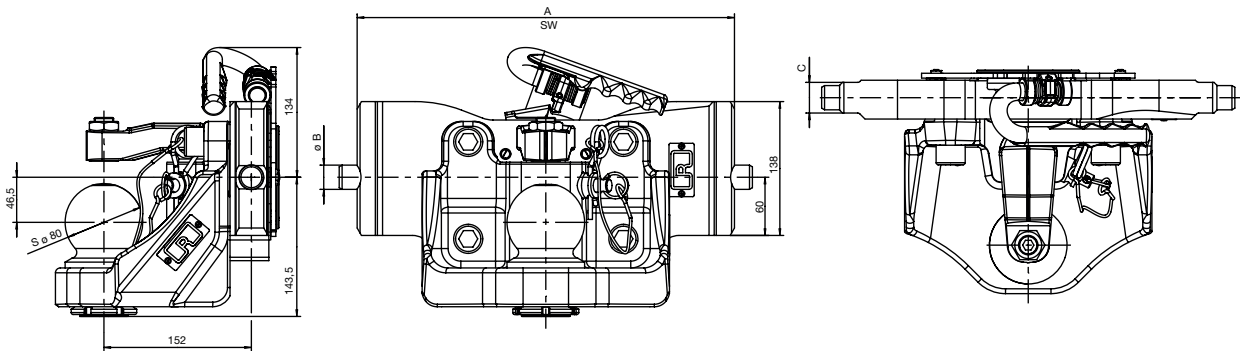

Auswahltabelle / Selection table

Artikel-Nr. / Order No.	Spurweite A,B,C / Track width A,B,C (mm)	S (t)	D (kN)	ABG (M)	EG (e1)	EA (TP)
RO825X10000	310/22/30	4,0	100,0	✓	✓	
RO825X12090 ¹	120/22/30	3,0	98,1	✓	✓	
RO825X23000	323/22/30	4,0	100,0	✓	✓	
RO825X30000	330/25/32	4,0	100,0	✓	✓	
RO825X30090 ¹	330/25/32	4,0	100,0	✓	✓	
RO825X30040 ²	330/25/32	4,0	100,0	✓	✓	
RO825X36000	336/22/30	4,0	100,0	✓	✓	
RO825X90000	390/25/32	4,0	100,0	✓	✓	
RO825X90090 ¹	390/25/32	4,0	100,0	✓	✓	
RO825X90040 ²	390/25/32	4,0	100,0	✓	✓	
RO825X90070 ³	390/25/32	4,0	100,0	✓	✓	
RO825Y30000 ⁴	330/20/30	4,0	100,0	✓	✓	
RO825X20000 ⁵	320/30/20	3,0	100,0			✓

¹ AGCO grau/AGCO grey

² John Deere grün/John Deere green

³ CLAAS grau/CLAAS grey

⁴ Für CBM Original-Anhängebock/For CBM original-ladder

⁵ Für Saueremann Drehbolzensystem/For Saueremann system

Aufrüstsatz Zwangslenkung / Upgrade kit forced steering

Benennung / Description	Artikel-Nr. / Order No.
beidseitig/bothsides	ROE74L026

DE Technische Daten
nach ISO 24347

EN Technical data
According to ISO 24347

RO*825X

Ersatzteile / Spare parts

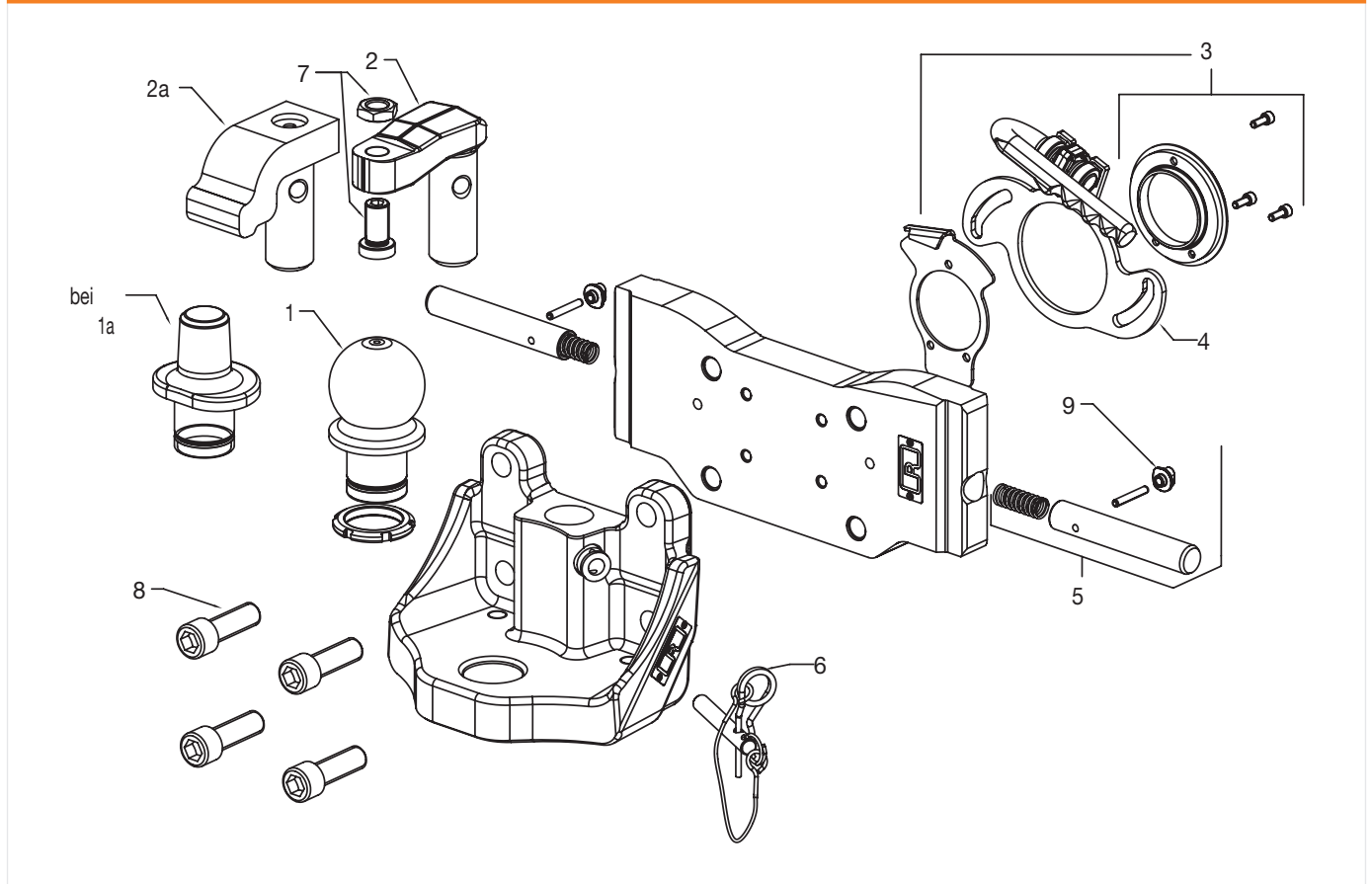

Auswahltabelle / Selection table

Pos. / Item	Benennung / Description	Spurweite / Track width (mm)		Bestell-Nr. / Order No.
1	Kugel 80/ball 80		1	ROE71177
1a	Piton Zapfen mit Mutter/piton with nut		1	ROE75L006
2	Niederhalter KS80/keeper KS80		1	ROE75L099
2a	Niederhalter Piton/keeper piton		1	ROE75L129
3	Befestigungssatz Kurvenscheibe/fastening set cam disc		1	ROE75L227
4	Kurvenscheibe/cam disc		1	ROE75L228
5	Arretierbolzen für Spurweiten/arresting bolt for track widths	D310	1	ROE75L180
5	Arretierbolzen für Spurweiten/arresting bolt for track widths	D312	1	ROE75L180
5	Arretierbolzen für Spurweiten/arresting bolt for track widths	D323	1	ROE75L181
5	Arretierbolzen für Spurweiten/arresting bolt for track widths	D330	1	ROE75L183
5	Arretierbolzen für Spurweiten/arresting bolt for track widths	D336	1	ROE75L182
5	Arretierbolzen für Spurweiten/arresting bolt for track widths	D390	1	ROE75L184
5	Arretierbolzen für Spurweiten/arresting bolt for track widths	F315	1	ROE75L238
5	Arretierbolzen für Spurweiten/arresting bolt for track widths	F330	1	ROE75L185
5	Arretierbolzen für Spurweiten/arresting bolt for track widths	F390	1	ROE75L237
6	Sicherung/lock		1	ROE75L077
7	Einstellschraube für Niederhalter/adjustment screw for keeper		1	ROE75L001
8	Schraubensatz/screw set		1	ROE74L052
9	Gleitsteine/sliding blocks		2	ROE75L187
	Staubschutzkappe für Kugel 80/dust cap for ball 80		1	ROE25522
	Kugelwinkel/ball angle			RO825B50002
	Pitonwinkel/piton angle			RO820B50000

