

# Assembly Instructions

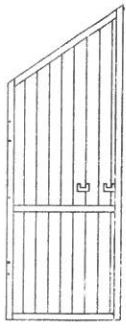

1PC

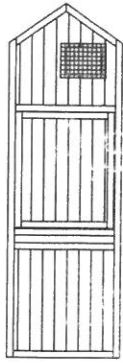

1PC

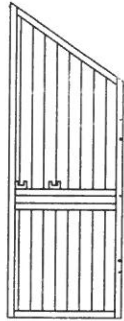

1PC

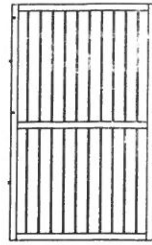

1PC

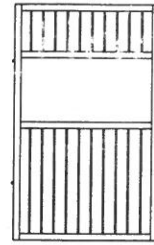

1PC



1PC



1PC



1PC

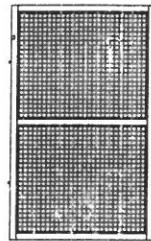

1PC

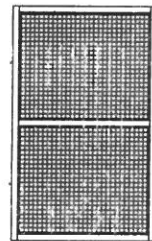

1PC

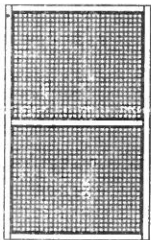

1PC

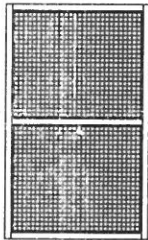

1PC

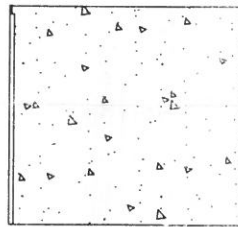

2PCS

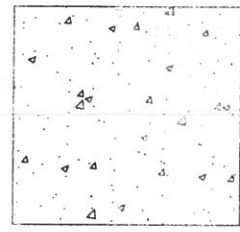

2PCS



1PC



1PC



1PC



2PCS

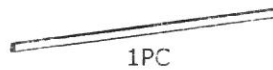

1PC



2PCS

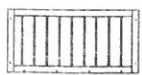

1PC



1PC



1PC



1PC



1PC



1PC



2PCS



2PCS

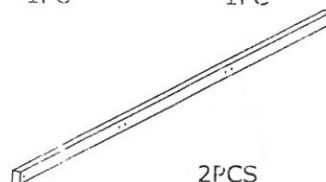

2PCS

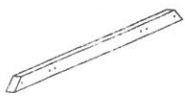

2PC



4PCS

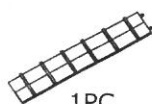

1PC



2PCS



2PCS

(A)  M3.5X60  
26+1

(B)  M3.5X50  
33+2

(C)  M3.5X40  
40+2

(D)  M3.5X35  
16+1

(E)  M3.5X25  
20+1

(F)  M3.0X16  
44+4



x6



x2



x2



x2



x1



x2

STEP-01

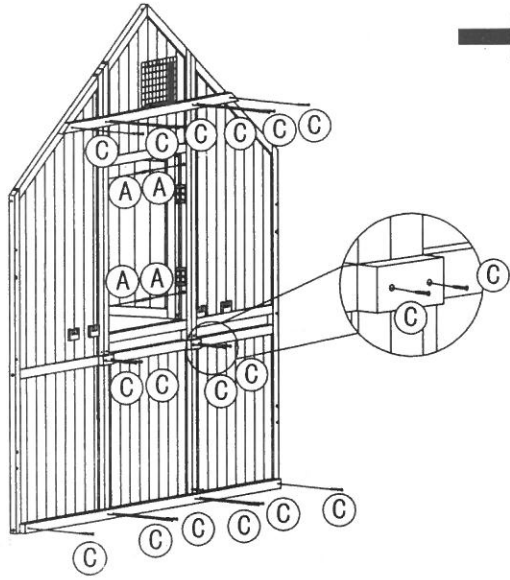

STEP-02

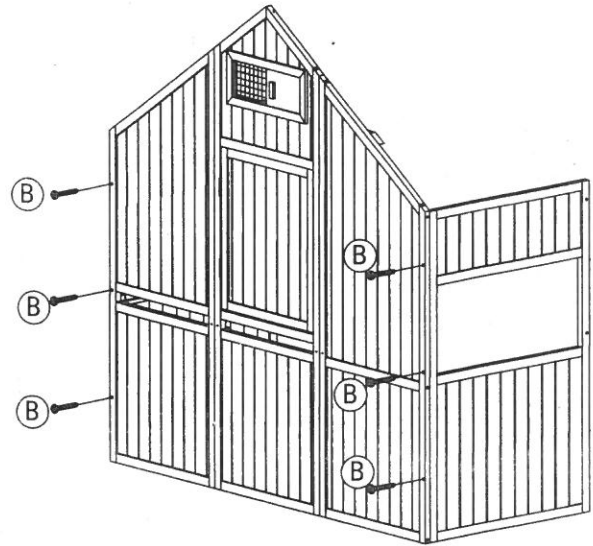

STEP-03

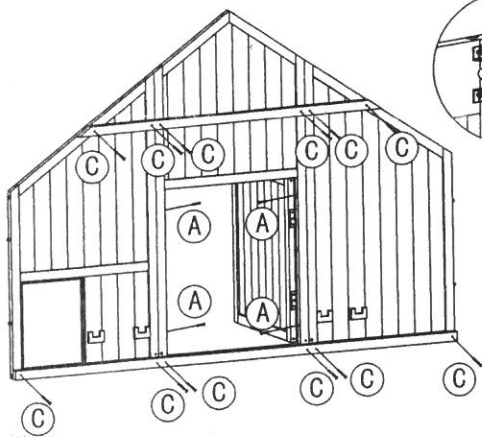

STEP-04

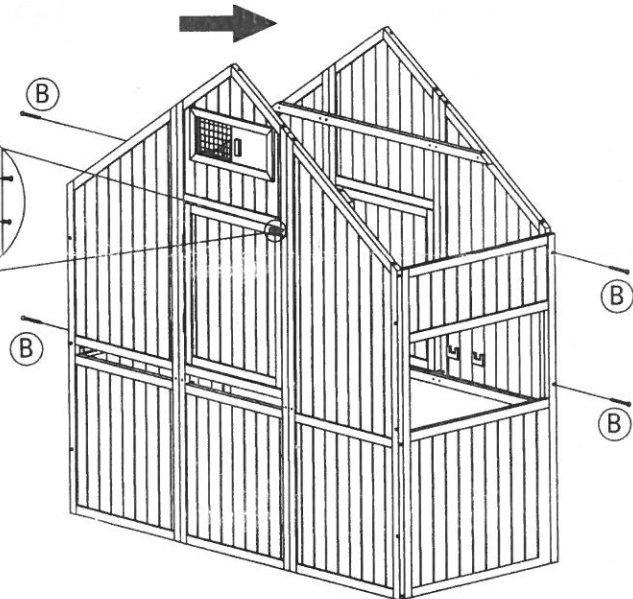

STEP-05

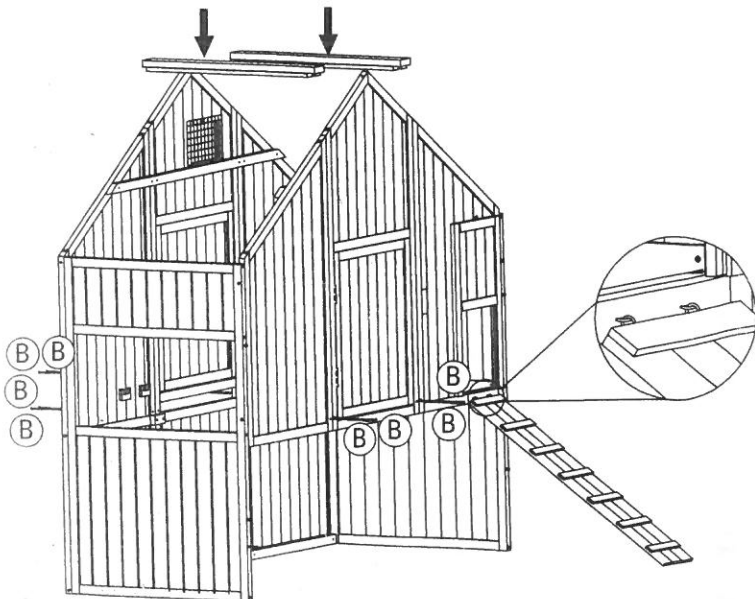

STEP-06

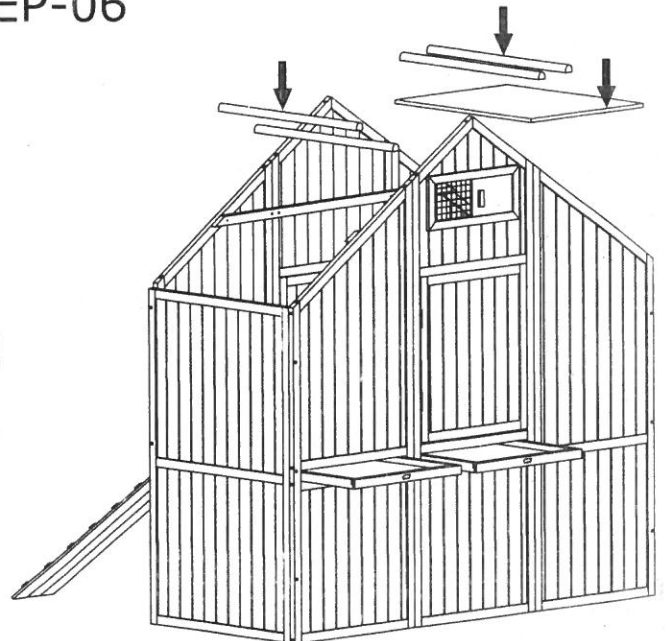

# STEP-07

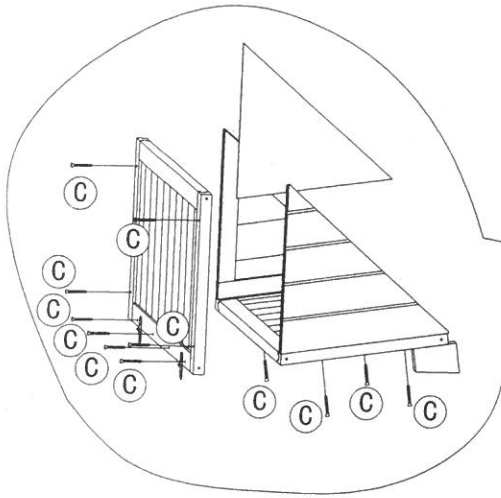

# STEP-08



# STEP-09

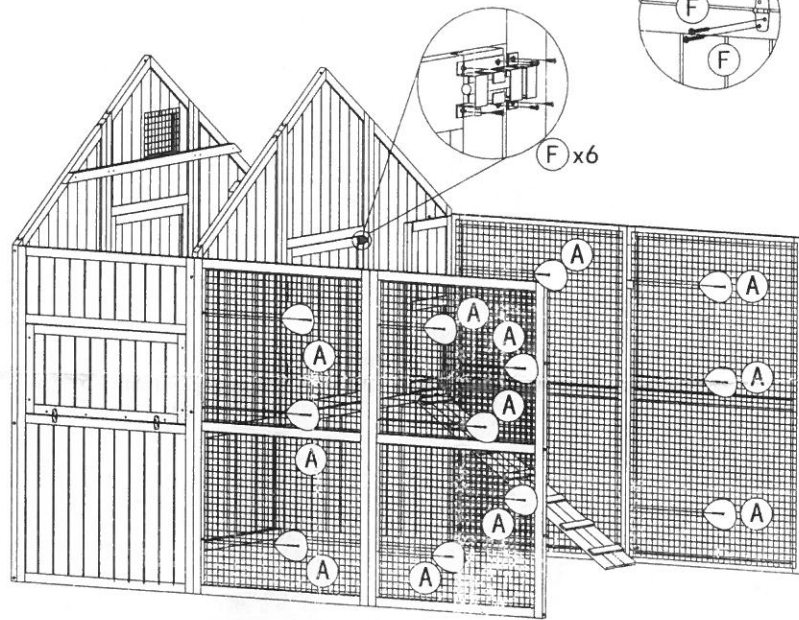

# STEP-10

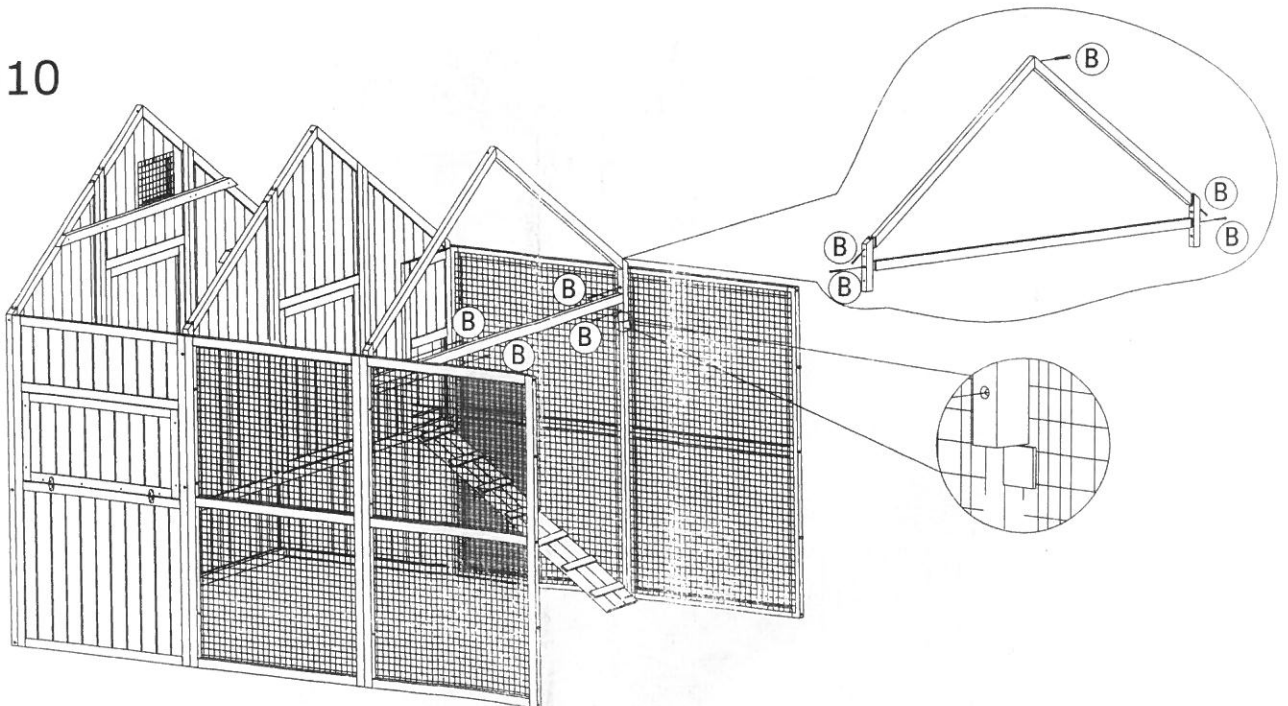

# STEP-11

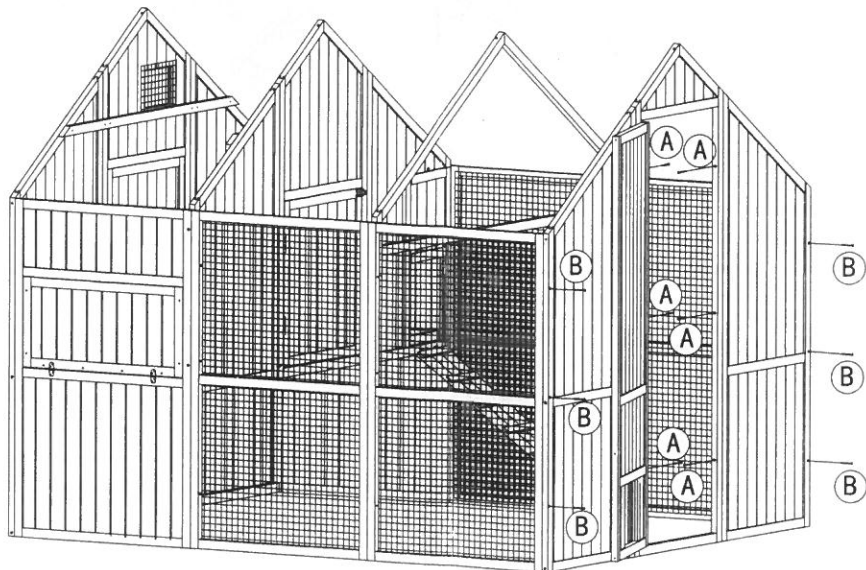

# STEP-12

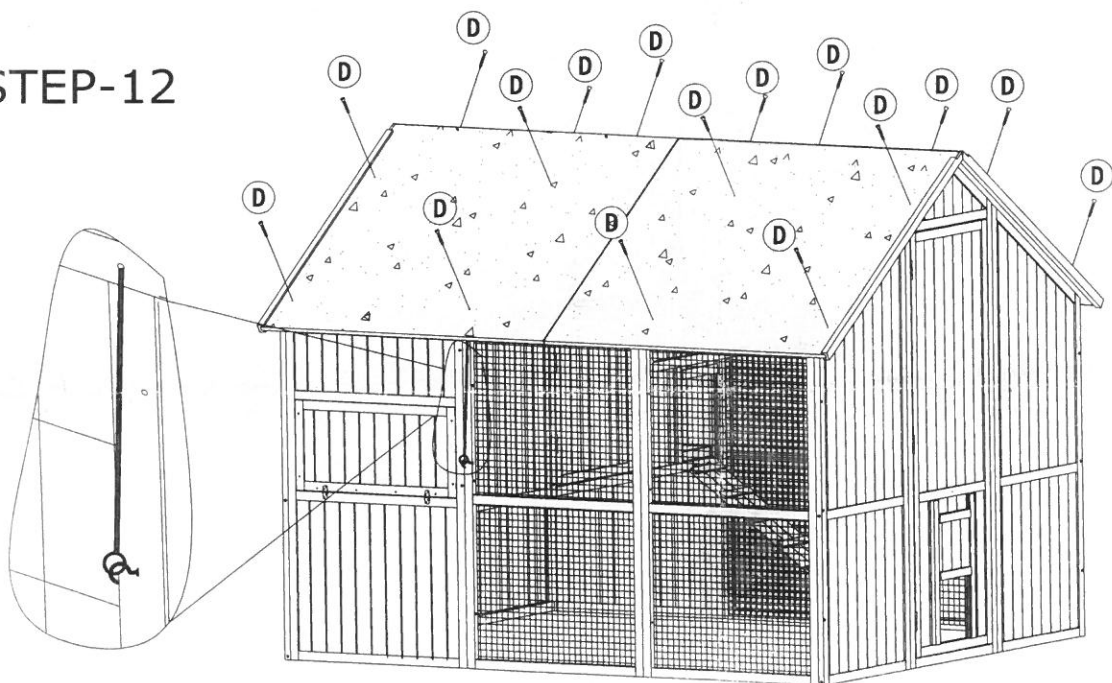

# STEP-13

