

MH 3M - MH 4M MH 5M - MH 6P - MH 7P

Instructions for use

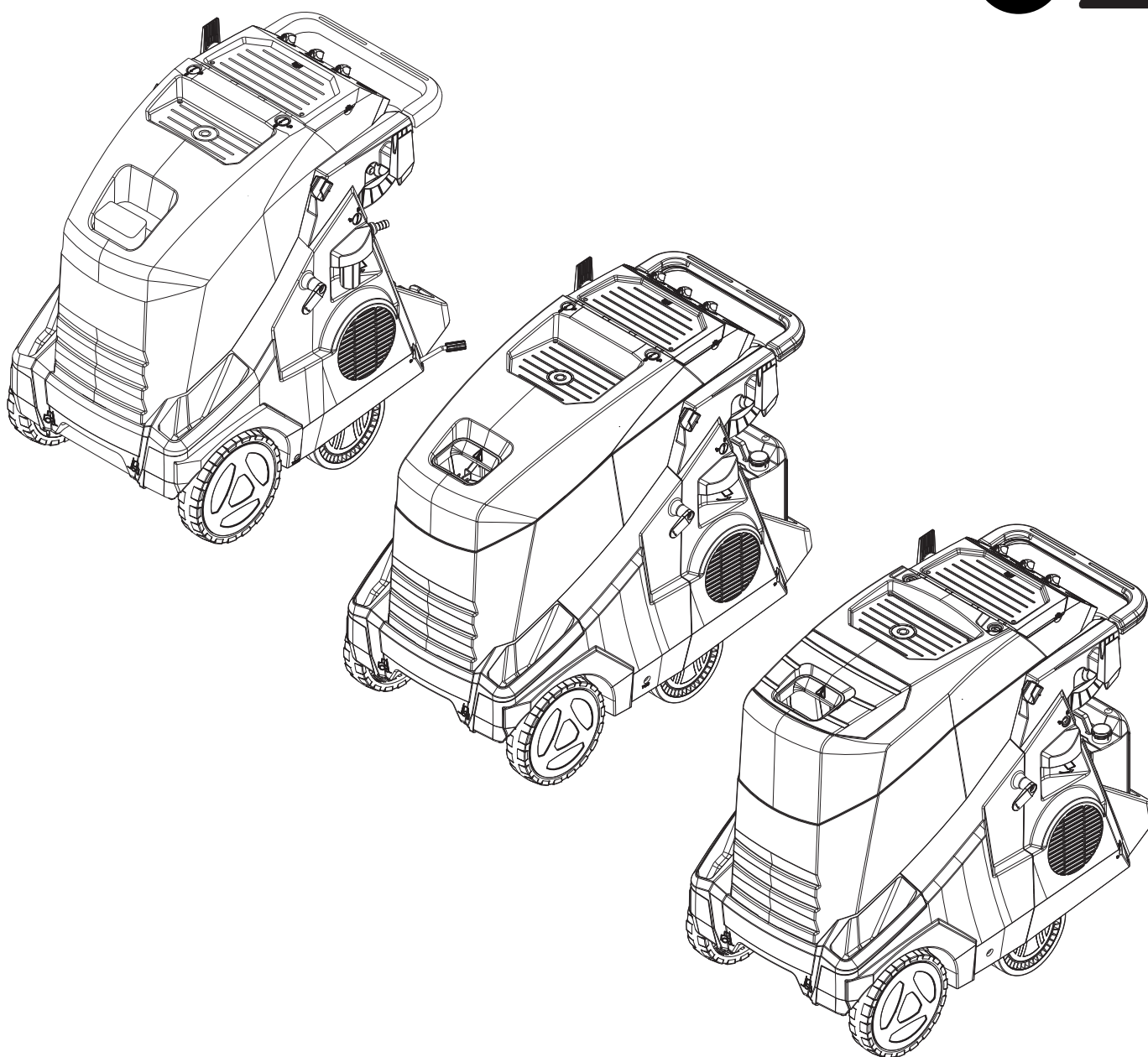

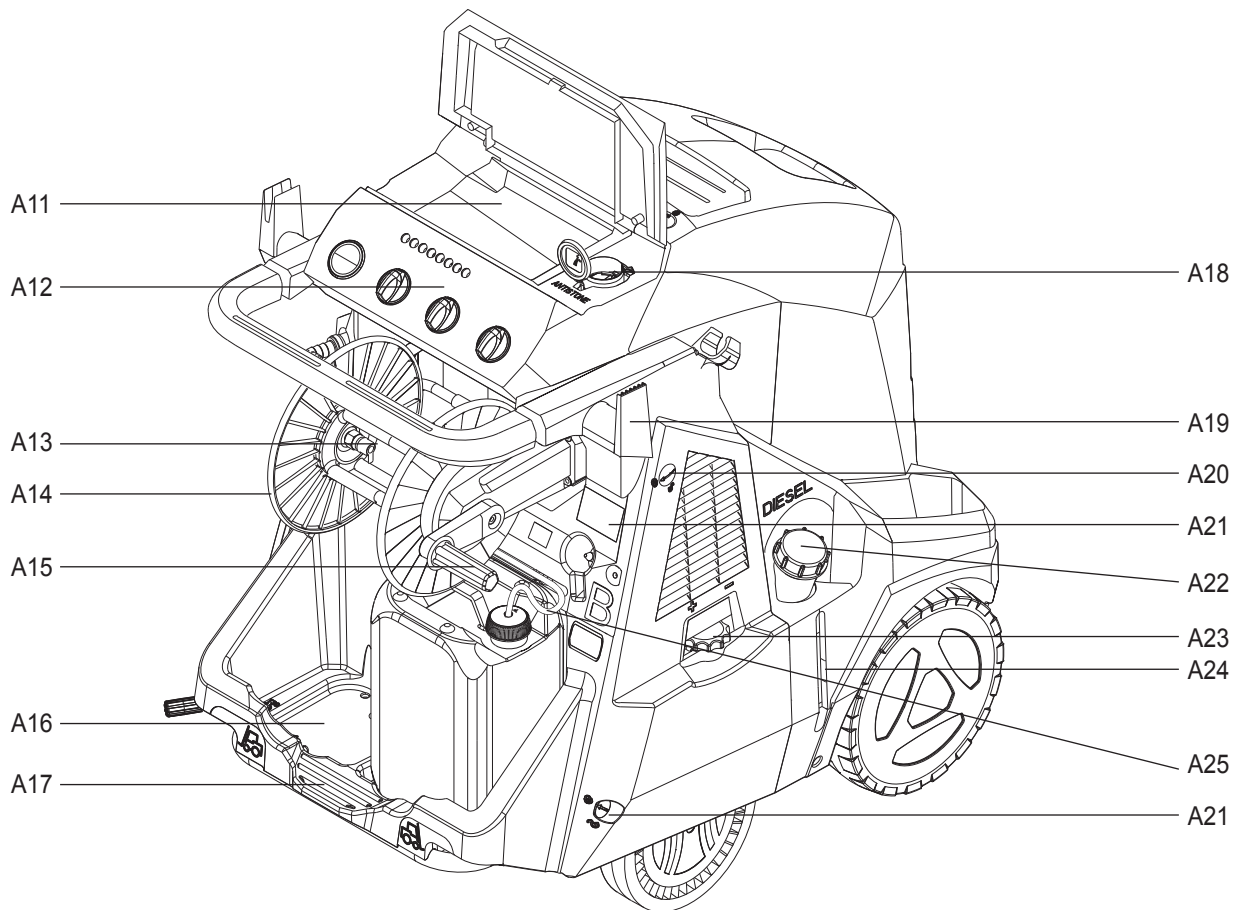
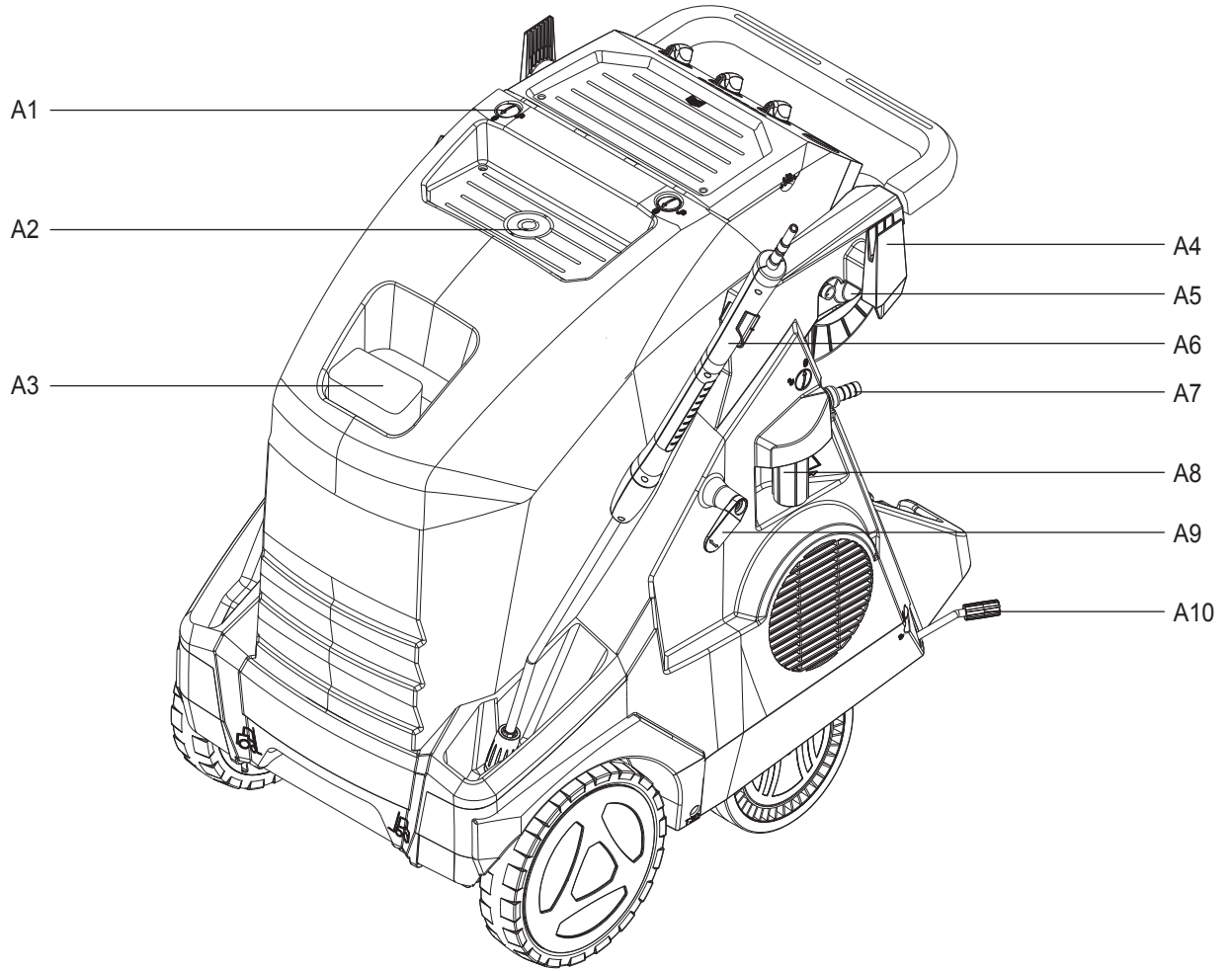

A

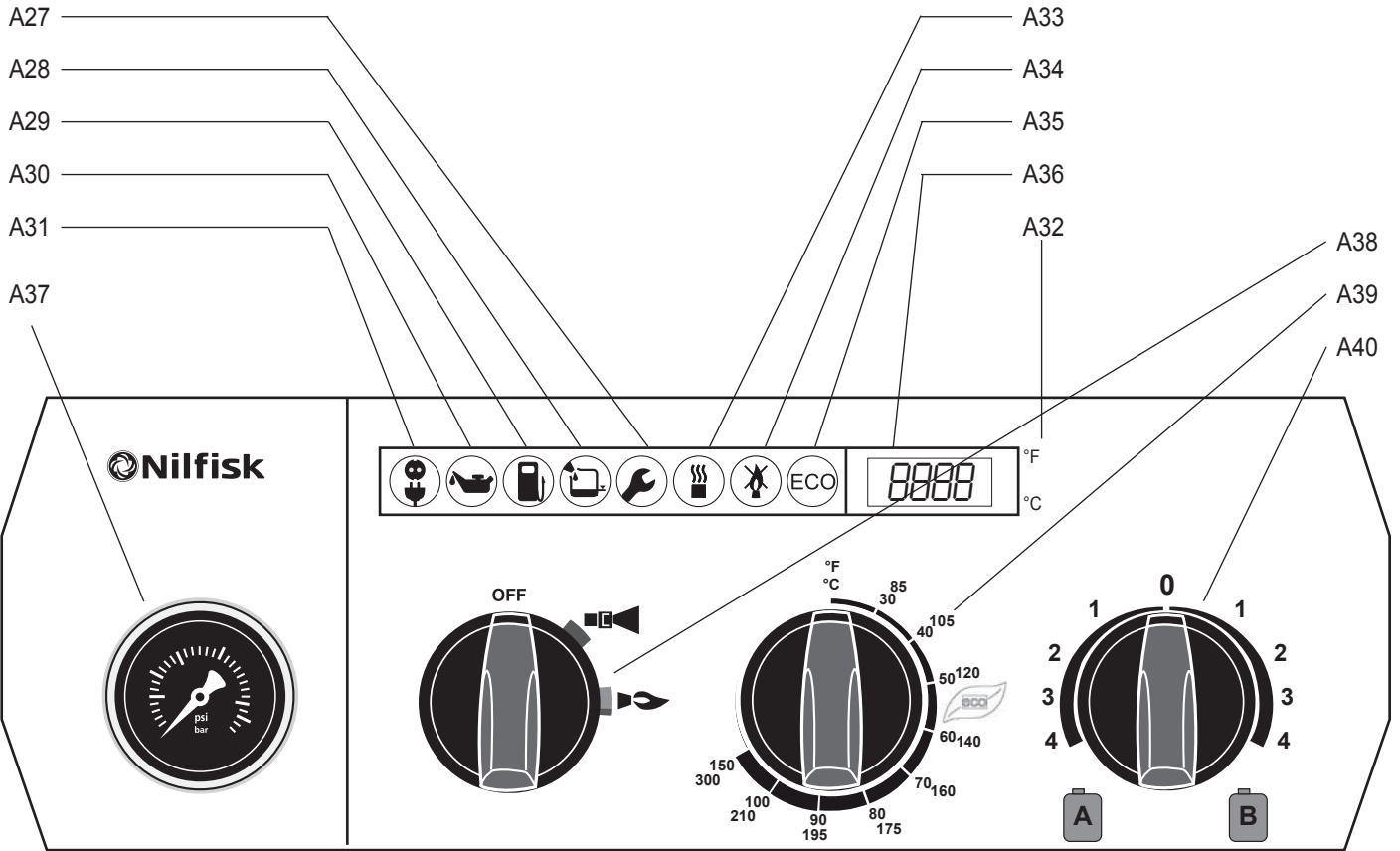

B

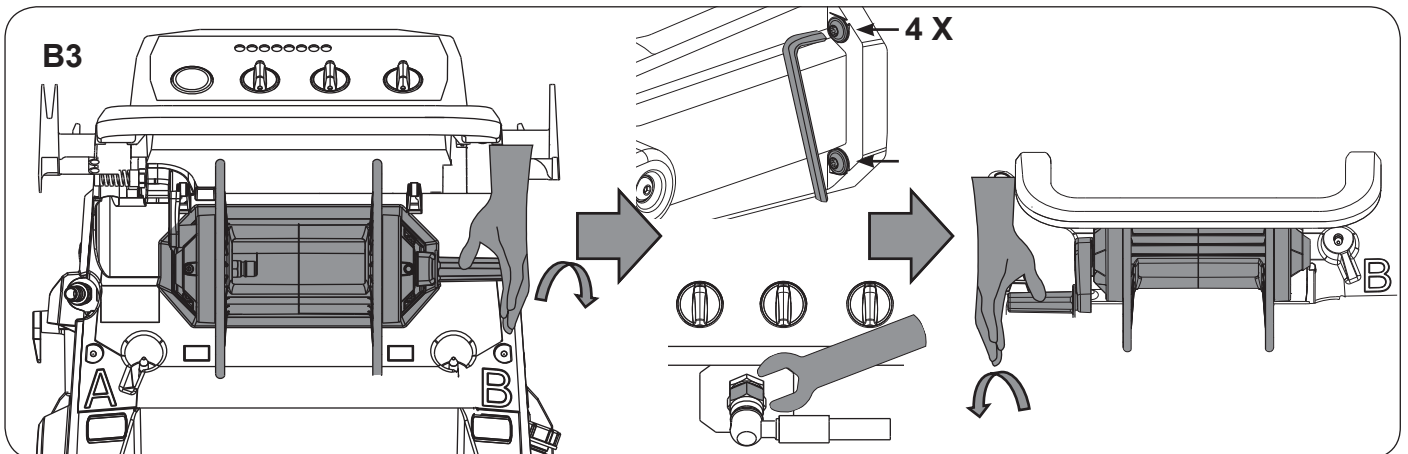
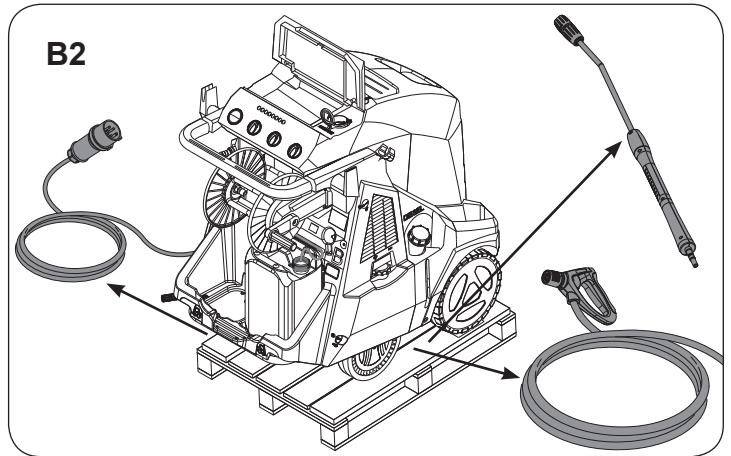
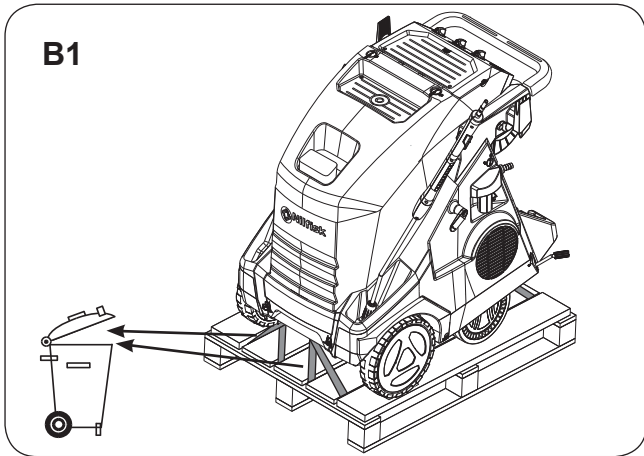

B4.a

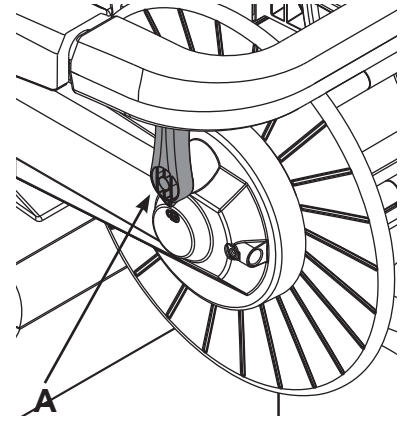
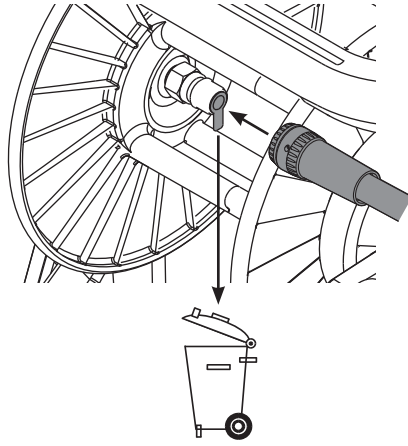
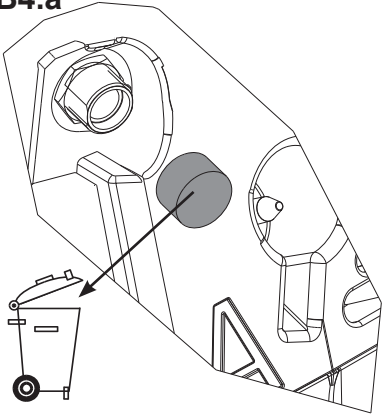

B4.b

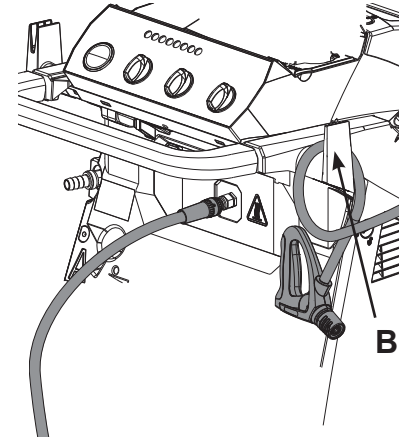
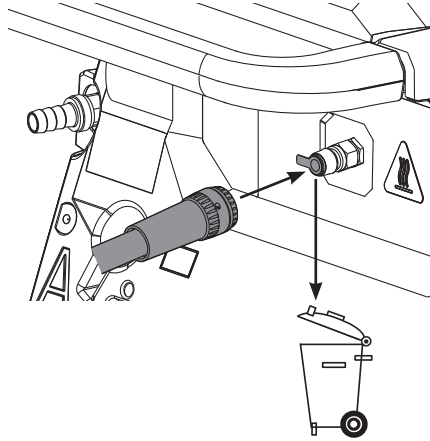
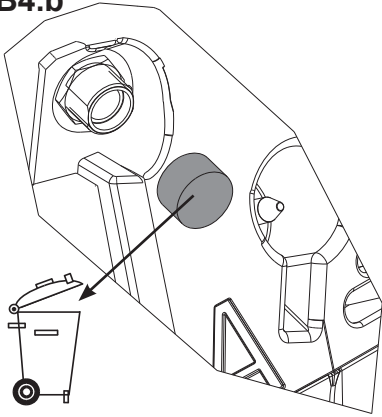

B5

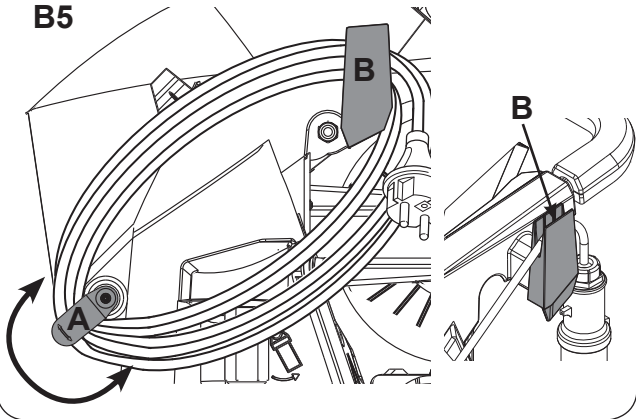

B6

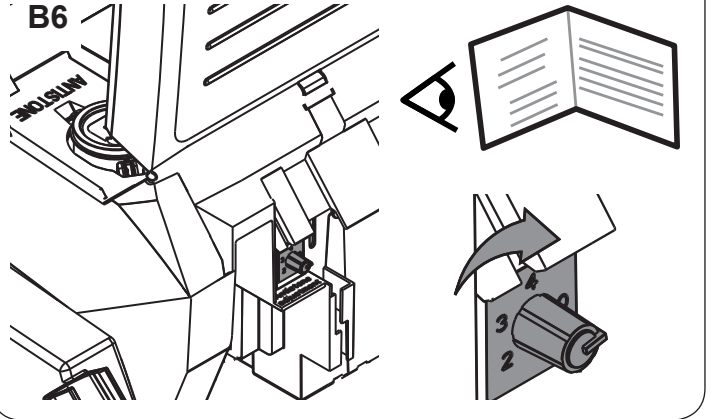

B

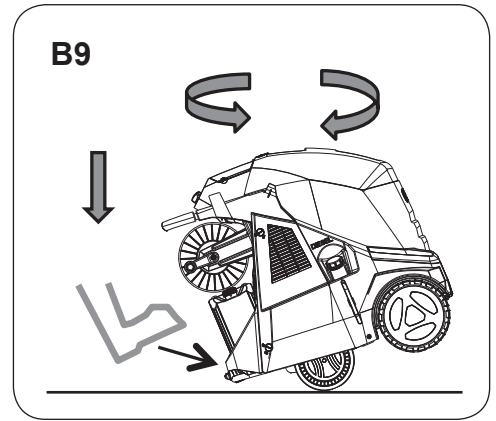
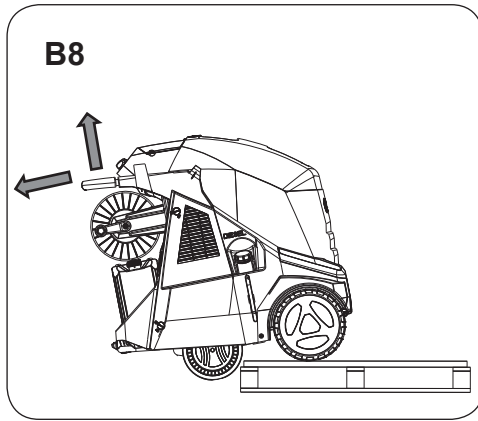
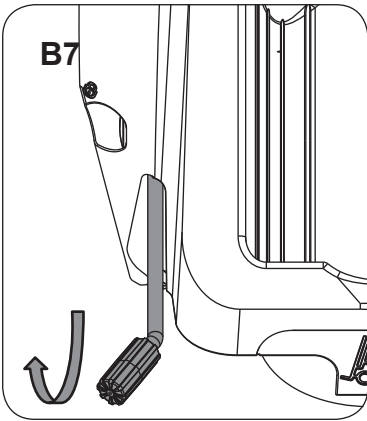

C

C1.a

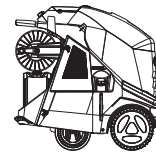
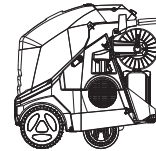
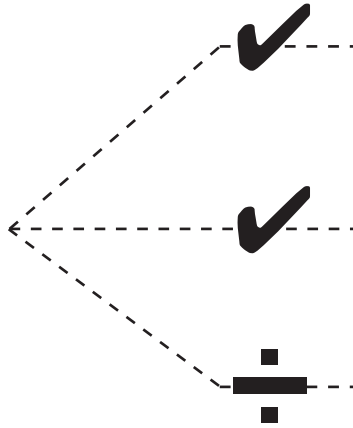
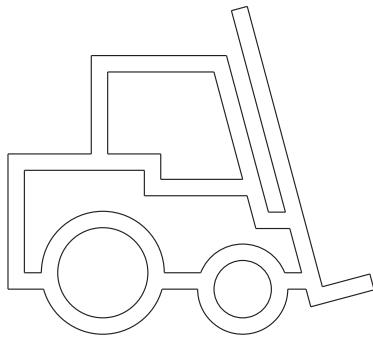

C1.b

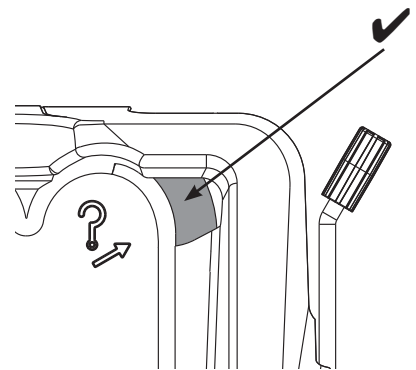
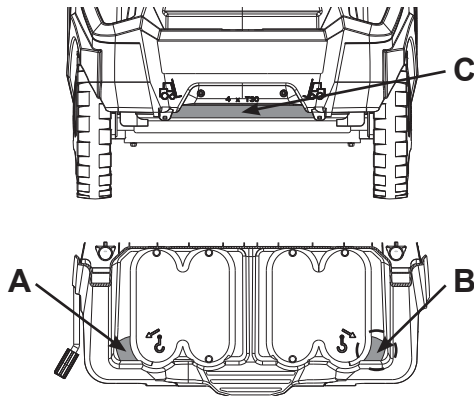
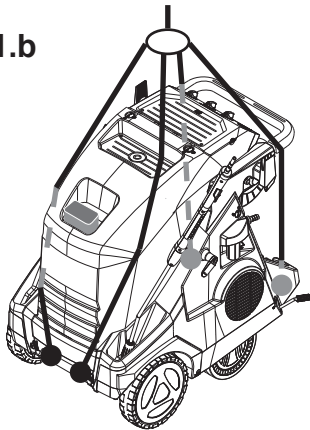

C1.c

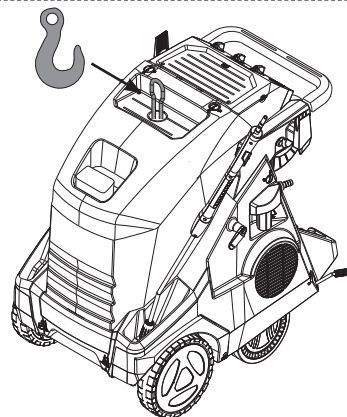
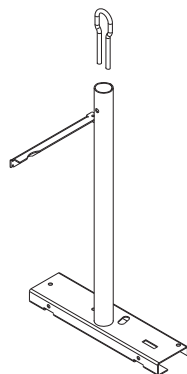

C

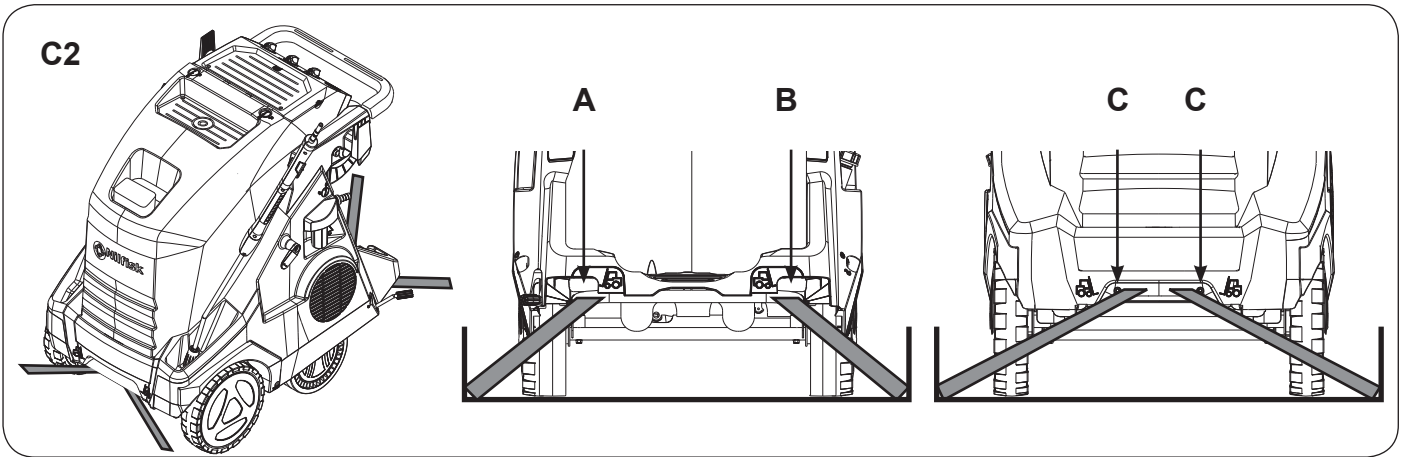

D

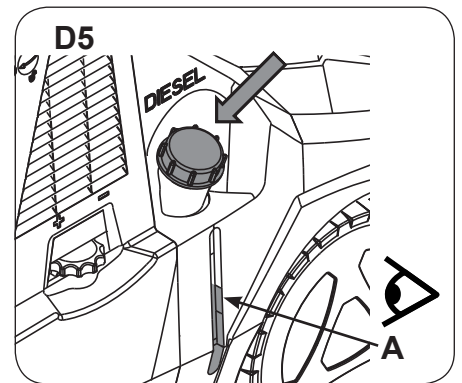
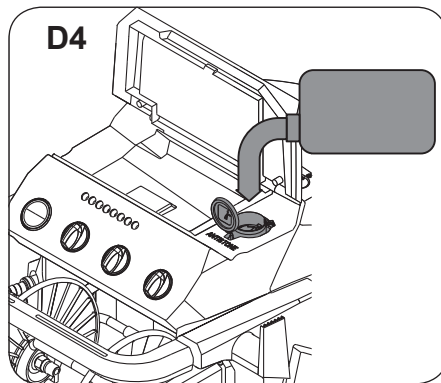
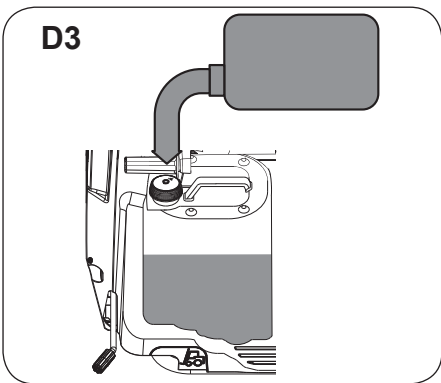
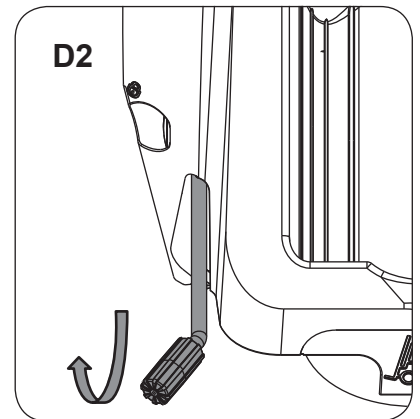
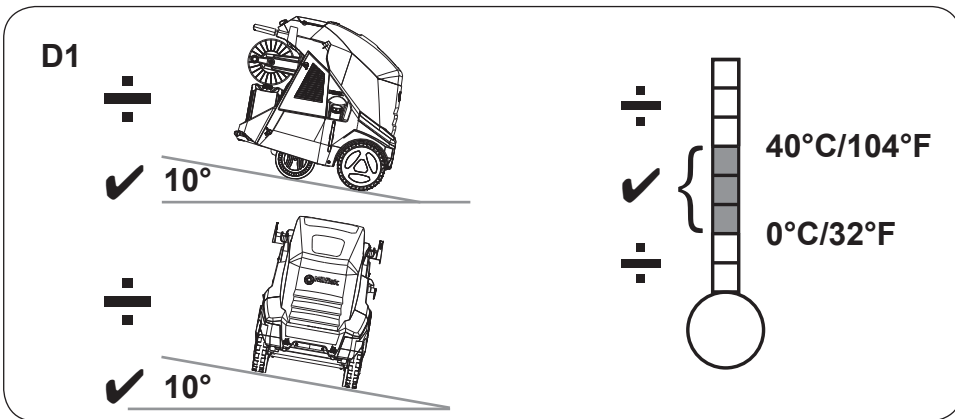

E

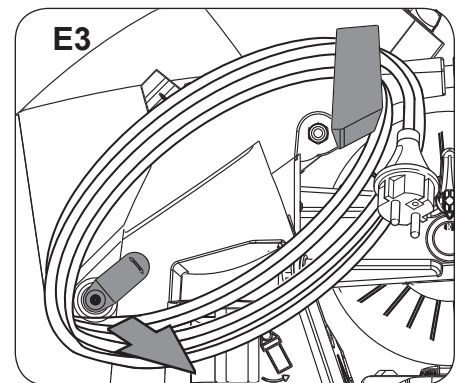
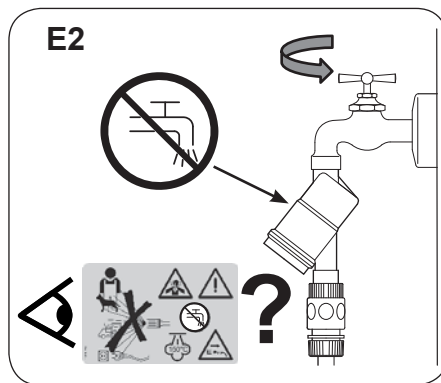
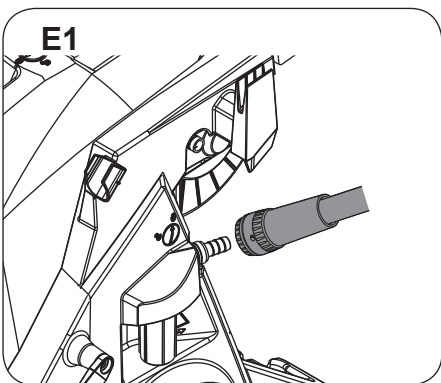

E4

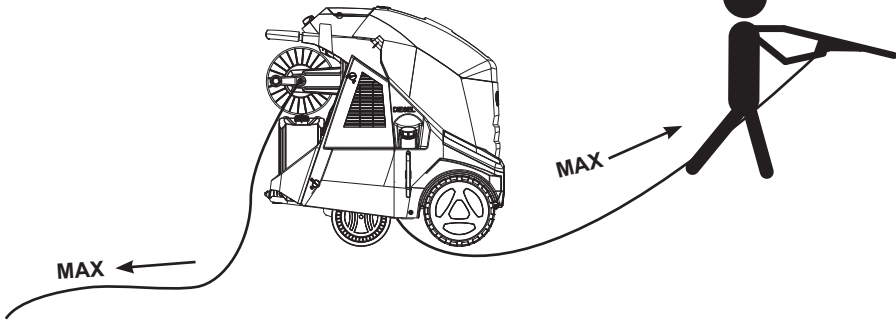

E5

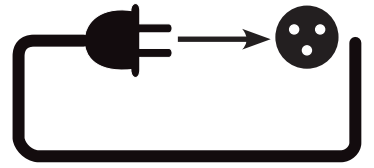

E6

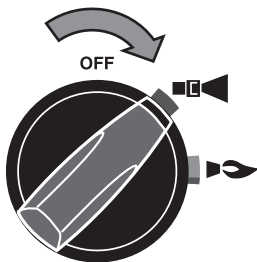

E7

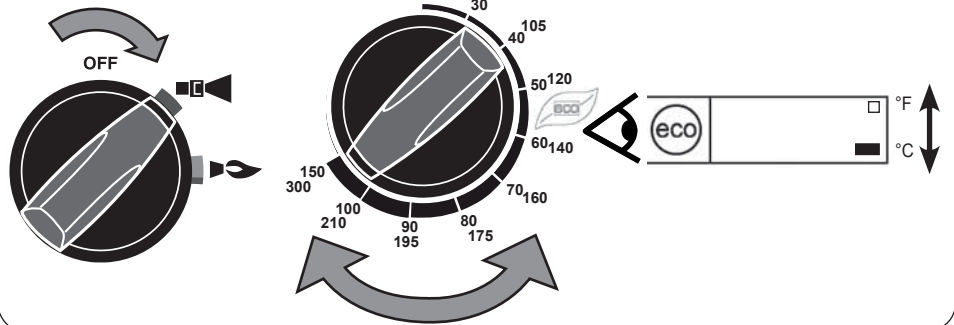

E8

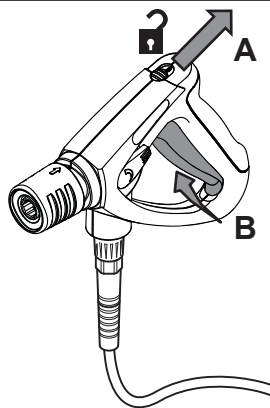
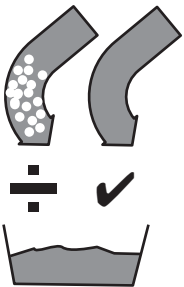

E9

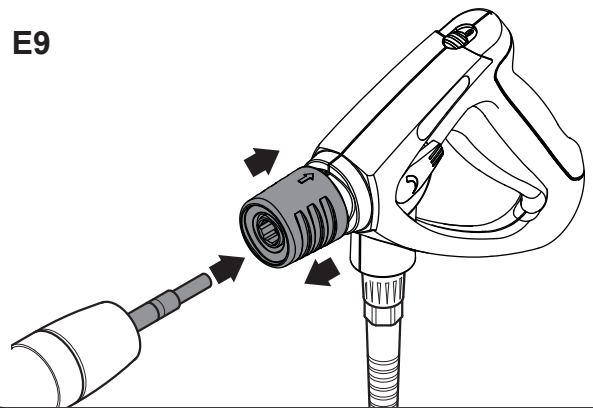

E10.a

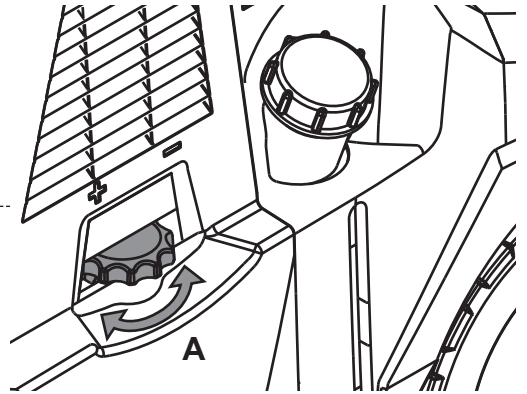
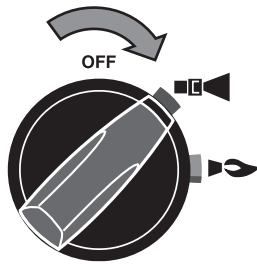

E10.b



Max 100°C/210°F

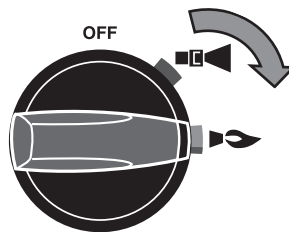
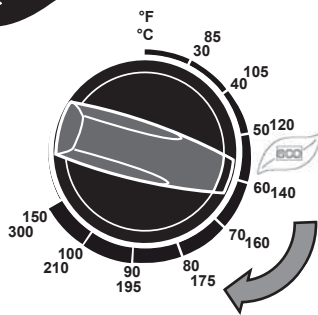

E10.c

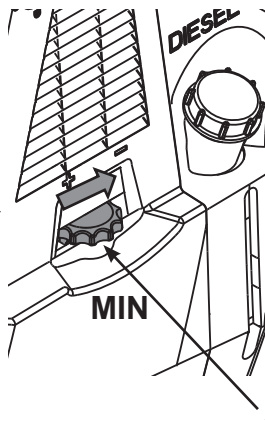
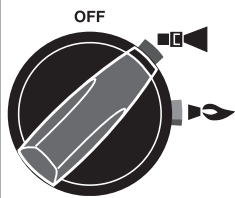

Max 32 bar

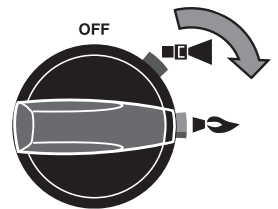
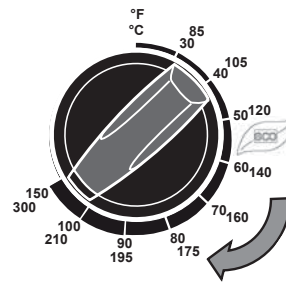

E

E11

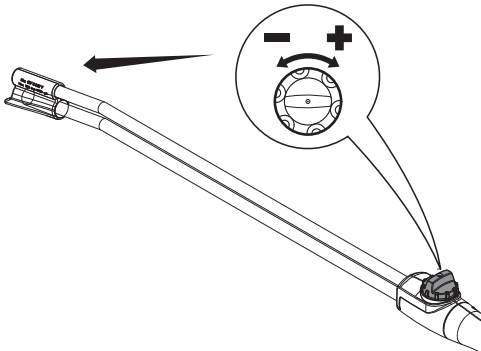
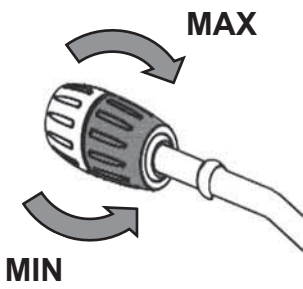
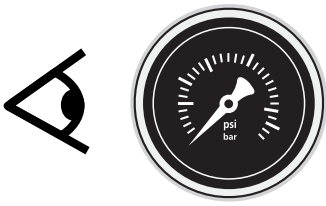

E12

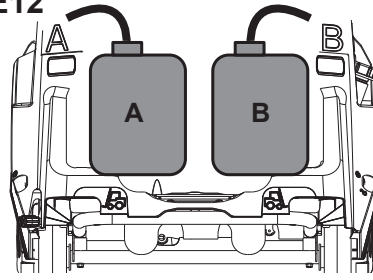

E12.b

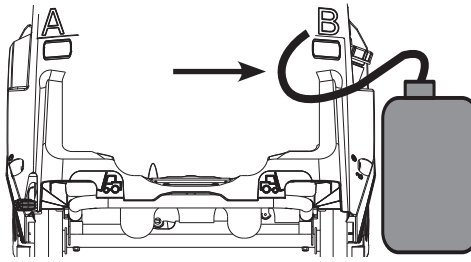

E12.c

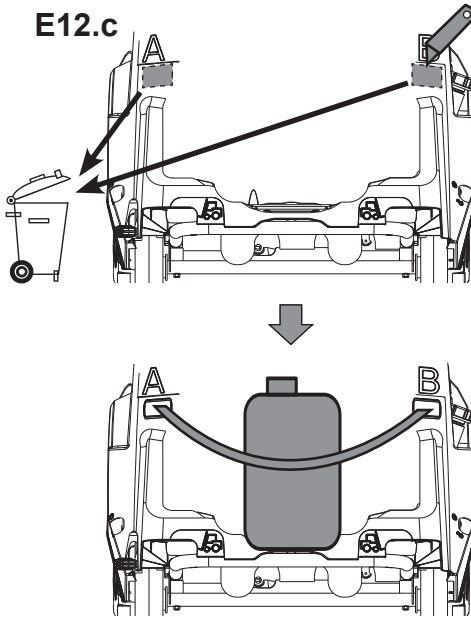

E13

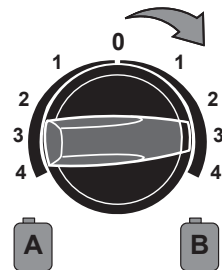
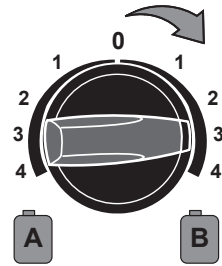
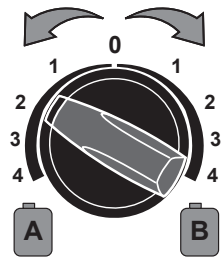

F

F1

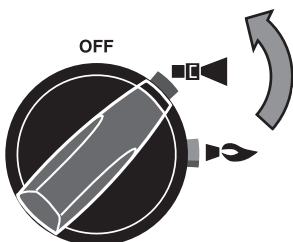

F2

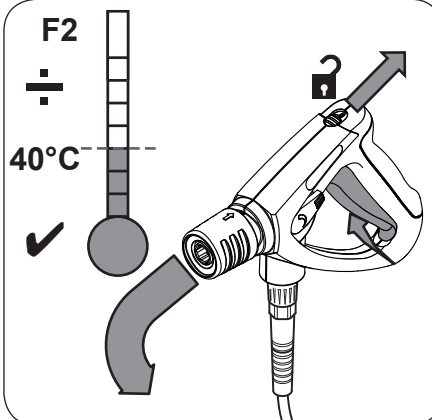

F3

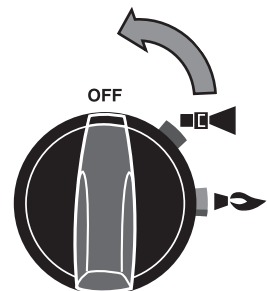

F

F4

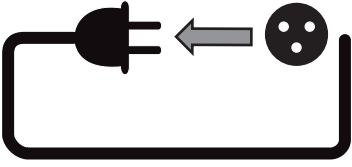

F5

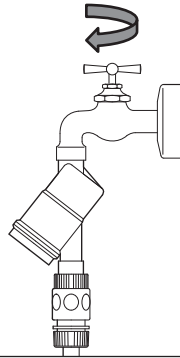

F6

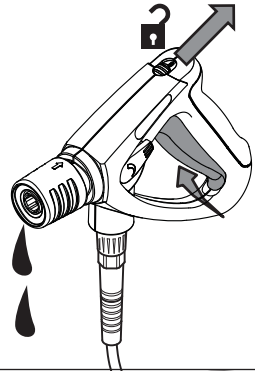

F7

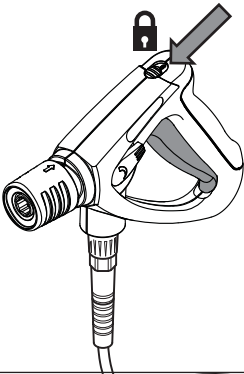

G

G1

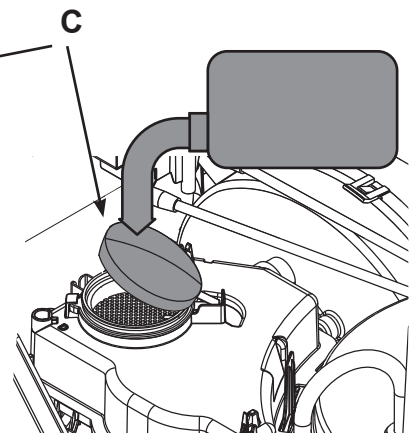
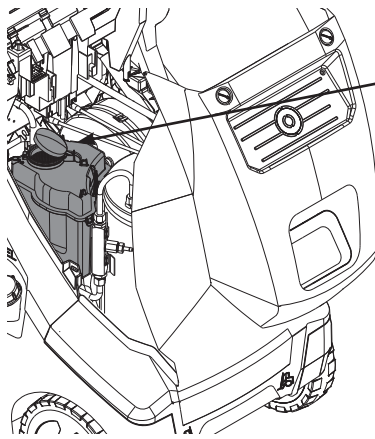
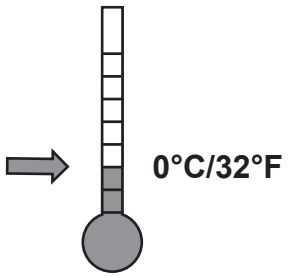

G2

B

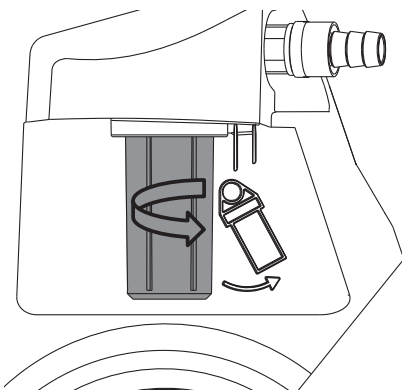

C

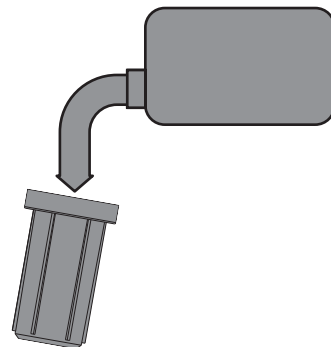

H1.a

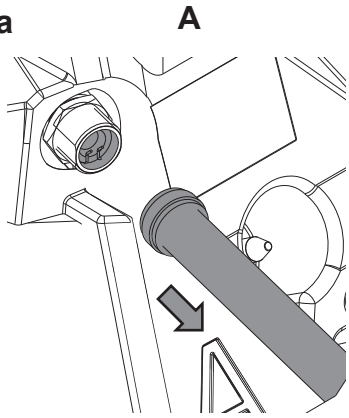

B

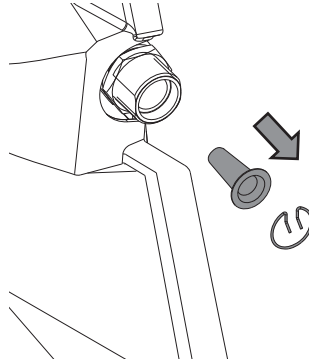

C

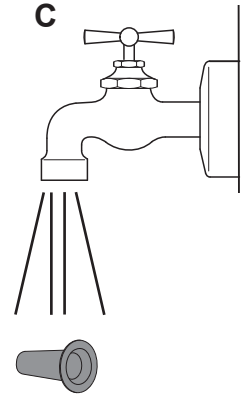

H1.b

A

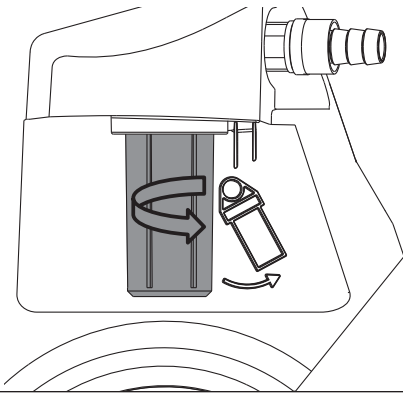

B

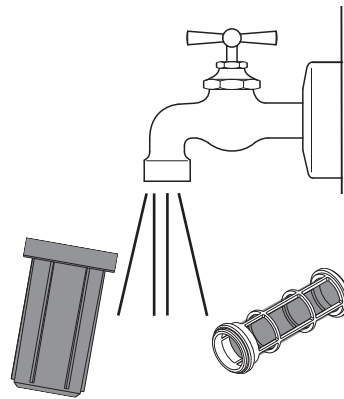

H2

A

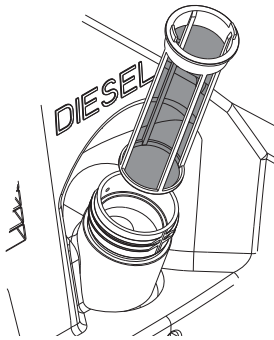

B

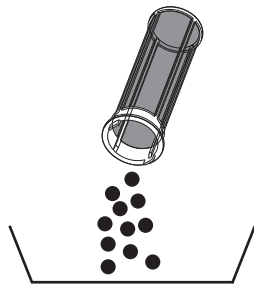

H3

A

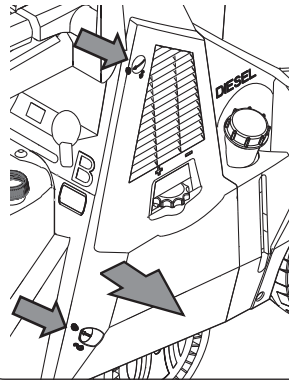

B

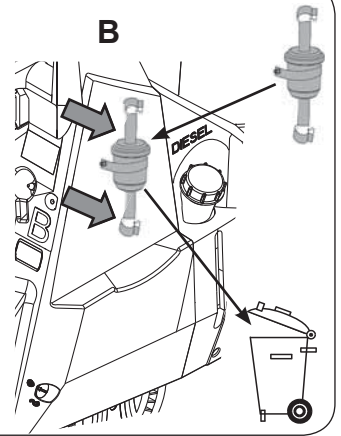

H4

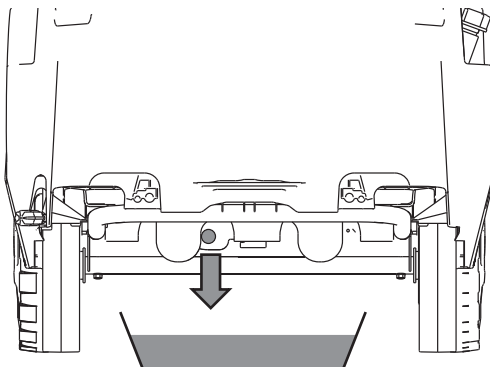

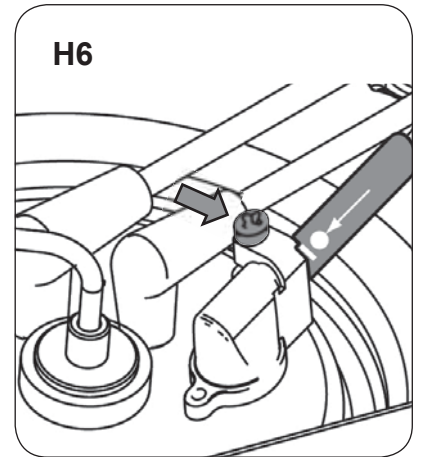
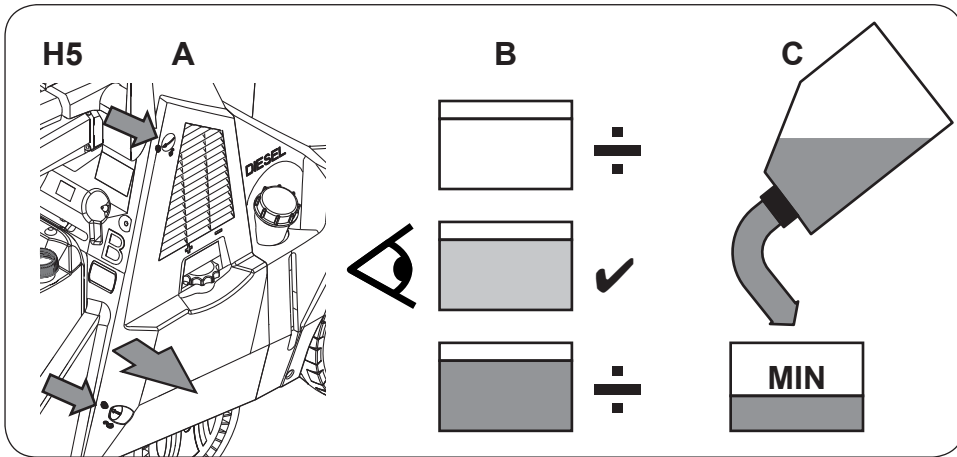

EN	Operating instructions	14
DE	Bedienungsanweisungen	18
FR	Instructions de fonctionnement	22
NL	Gebruiksaanwijzingen	26
IT	Istruzioni per l'uso	30
NO	Bruksanvisning	34
SV	Bruksanvisning	38
DA	Betjeningsvejledning	42
FI	Käyttöohje	46
ES	Instrucciones de funcionamiento	50
PT	Instruções de Funcionamento	54
EL	Οδηγίες λειτουργίας	58
TR	Kullanma Talimatları	63
SL	Navodila za delovanje	68
HR	Upute za uporabu	72
SK	Návod na obsluhu	76
CS	Návod k obsluze	80
PL	Instrukcje dotyczące obsługi	84
HU	Használati útmutató	88
RO	Instrucțiuni de utilizare.....	92
BG	Указания за експлоатация	96
RU	Руководство по эксплуатации	101
ET	Tööjuhised	106
LV	Norādījumi par ekspluatāciju	110
LT	Naudojimo instrukcija	114
JA	作手順.....	118
ZH	操作说明.....	122
KO	사용법.....	126
TH	คำแนะนำการใช้งาน.....	130
MS	Arahan Operasi	134

Betriebsanleitung

Dieser Hochdruckreiniger ist für den professionellen Einsatz vor allem in den folgenden Anwendungsbereichen bestimmt: Landwirtschaft, Industrie, Transport, Kraftfahrzeugreinigung, kommunale Einrichtungen, Reinigungsgewerbe, Bauindustrie, Nahrungsmittelindustrie usw.

Illustrierte Kurzanleitung

Die illustrierte Kurzanleitung soll Sie bei Inbetriebnahme, Benutzung und Lagerung des Geräts unterstützen. Die Anleitung ist in acht Abschnitte gegliedert.

A

Vorbereitung

LESEN SIE BITTE VOR DER BENUTZUNG DIE SICHERHEITSHINWEISE!

Bedienelemente:

- A1. Deckelöffner
- A2. Aufnahme für Service-Kran und Hebering¹⁾
- A3. Hießluftauslass
- A4. Kabelverschluss
- A5. Hochdruck-Schlauchtrommel-Verschluss¹⁾
- A6. Sprühhrohr
- A7. Wasseranschluss
- A8. Wassereinflussfilter¹⁾
- A9. Verstellbarer Kabelverschluss
- A10. Feststellbremse
- A11. Werkzeugkasten
- A12. Bedienfeld
- A13. Hochdruck-Schlauchanschluss am Gerät B4.a/B4.b¹⁾
- A14. Hochdruck-Schlauchtrommel¹⁾
- A15. Hebelgriff für Hochdruck-Schlauchtrommel¹⁾
- A16. Reinigungskanisteraufnahme
- A17. Fußbrett zum Neigen des Geräts
- A18. Tanköffnung für Nilfisk AntiStone
- A19. Hochdruckschlauch-Verschluss
- A20. Seitentürgriff
- A21. Sicherheitsetikett
- A22. Kraftstofftanköffnung
- A23. Sprühpistolenhalter
- A24. Wassermengenregler¹⁾
- A25. Kraftstoffstand-Anzeige
- A26. Langer Reinigungsmittelschlauch für externen Kanister
- A27. Service-Intervall fällig/überschritten LED
- A28. Nilfisk AntiStone niedrig¹⁾ LED
- A29. Kraftstoff niedrig¹⁾ LED
- A30. Pumpenölstand niedrig¹⁾ LED
- A31. Hauptschalter EIN LED
- A32. Fahrenheit /Celsius Anzeiger¹⁾
- A33. Erhitzer überhitzt LED
- A34. Keine Flamme LED
- A35. ÖKO-Modus LED
- A36. Stundenzähler; Solltemperaturanzeige; Fehlercodes¹⁾
- A37. Druckanzeige¹⁾
- A38. Hauptschalter mit Kalt-/Heißwasserauswahl
- A39. Knopf zur Temperaturreglersteuerung
- A40. Messknopf für Reinigungsmittel¹⁾

B

Auspacken und Vorbereiten des Geräts

- B1. Transportschutz vom Gerät entfernen.
- B2. Schlauch, Sprühhrohr und Kabel von der Palette entnehmen.

- B3. Bei Bedarf kann die Schlauchtrommel von Rechtshand- und Linkshandbedienung umgestellt werden¹⁾.
- B4.a Modelle mit Schlauchtrommel: Transportkappen von Ein- und Auslass entfernen. Hochdruckschlauch anschließen, auf der Schlauchtrommel aufrollen und die Schlauchtrommel am Griff (A) befestigen¹⁾.
- B4.b Modelle ohne Schlauchtrommel: Transportkappen von Ein- und Auslass entfernen. Hochdruckschlauch anschließen und auf dem Haken (B) platzieren.
- B5. Stromkabel um den Kabelverschluss (A und B) wickeln und das Kabelende am Verschluss (B) befestigen.
- B6. Das Nilfisk Antiscale Gerät ist ab Werk auf eine mittelharte Wasserhärte eingestellt. Siehe Tabelle im Abschnitt Wartung. Bei Einstellung auf „0“ wird die Warmmeldung verworfen.
- B7. Radbremse lösen.
- B8. Hebel anheben und das Hinterrad des Reinigers von der Palette auf den Boden ziehen.
- B9. Zum einfachen Neigen und Manövrieren auf das Fußbrett treten und den Hebel nach unten drücken.

C

Heben und Verzurren zum Transport

- C1.a Die sicherste Methode zum Heben des Reinigers ist die Nutzung eines Gabelstaplers am vorderen oder hinteren Ende des Reinigers. (Nicht von der Seite!).
- C1.b Beim Anheben mit Gurten die Hebepunkte (A,B,C) verwenden. Die Gurte nicht an den Kunststoffteilen des Geräts befestigen, da diese sich vom Rahmen lösen könnten.
- C1.c Wird das Gerät regelmäßig gehoben, wird der Nilfisk Hebesatz (#107140912 + #301001090) empfohlen.
- C2. Zum Fixieren mithilfe von Gurten für den Transport die Hebepunkte (A,B,C) verwenden. Die Gurte nicht an den Kunststoffteilen befestigen, da diese sich vom Rahmen lösen könnten.

D

Einrichten des Geräts:

Befindet sich Ihr Standort mehr als 500 m über dem Meeresspiegel, muss der Brenner eventuell für eine optimale Leistung und Kraftstoffeffizienz neu eingestellt werden. Wenden Sie sich an den Nilfisk Service. Bei Standorten mit einer Höhe von 1000 bis 2500 m über dem Meeresspiegel ist eventuell der optionale Brennersatz erforderlich. Wenden Sie sich an den Nilfisk Service.





Vor dem ersten Einsatz des Reinigers gründlich auf Fehler oder Schäden prüfen. Das Gerät nur in einem einwandfreien Zustand betreiben.

- D1. Die Neigung des Untergrundes für den Hochdruckreiniger darf zu keiner Seite 10° übersteigen.
OBS: die Umgebungstemperatur muss zwischen 0°C und 40°C liegen.
- D2. Bremse betätigen.
- D3. Reinigungsbehälter füllen¹⁾.
- D4. Behälter für Nilfisk AntiStone füllen¹⁾.
- D5. Kraftstofftank mit frischem Kraftstoff, Heizöl, DIN 51603-1 (Ohne Bio-Diesel) befüllen. Diesel gemäß DIN EN 590 (bis zu 7% Bio-Diesel) darf bei über 0°C Umgebungstemperatur unter folgenden Einschränkungen eingesetzt werden: Maximale Lagerdauer im Kraftstoffbehälter des Hochdruckreinigers: 1 Monat. Diesel, das älter als 6 Monate ist, darf nicht eingesetzt werden. Diesel nach DIN EN 590 aus einem offenen Behälter darf nicht eingesetzt werden.
Kraftstoffanzeiger (A) unter der Füllöffnung beachten.

E

Einschalten des Geräts

OBS: Das Gerät ist möglicherweise ab Werk mit Frostschutzmittel ausgestattet¹⁾ - Punkt E8 unten beachten.

- E1. Wasserversorgung anschließen.
- E2. Steht auf dem Sicherheitsetikett das Symbol , ist ein Rückflussventil erforderlich.
- E3. Kabelverschluss ziehen und das Kabel ausziehen.
- E4. Schlauch und Kabel vor Nutzung vollständig ausrollen.
- E5. Stromversorgung anschließen.
- E6. Einschalten des Reinigers. Kaltwasserbetrieb.
- E7. Fahrenheit /Celsius einstellen: (A) neben dem Ein-/Aus-schalter in den Kaltmodus stellen und (B) die Temperatursteuerung auf max drehen¹⁾.
- E8. Sicherheitsverschluss lösen und das Gerät durch Betätigen der Sprühpistole entlüften.
Befindet sich Frostschutzmittel im Reiniger, sammeln Sie die ersten 5 Liter der Flüssigkeit zur späteren Nutzung in einem Behälter. Bei gleichmäßigem Wasserfluss mit den folgenden Schritten fortfahren.
- E9. Sprührohr an die Sprühpistole anschließen.
- E10.a Kaltwassermodus.
Reiniger auf  schalten.
Die Flusssteuerung wird am Pumpengriff (A) eingestellt.
- E10.b Warmwassermodus (bis zu 100°C)
Temperatur wählen, ÖKO-Modus Einstellung für optimale Standard-Reinigung. Reiniger auf  schalten.
Die Flusssteuerung wird am Pumpengriff (A) eingestellt.
- E10.c Dampfmodus¹⁾ (über 100°C)
Flusssteuerung¹⁾ (A) vollständig bis zum rechten Stopp aufdrehen
(OBS: max. 32 bar bei Temperaturen über 100°C!).
Temperatur über 100°C wählen.
Reiniger auf  schalten.
- E11. Druckregelung mit FlexoPower oder Tornado Sprührohr¹⁾.
- E12.a Ansaugen aus internem Reinigungsmittelbehälter.
Gewünschte Konzentration von Reinigungsmittel (A) oder (B) am Dosierknopf einstellen¹⁾.
- E12.b Ansaugen aus internem Reinigungsmittelbehälter:
Schlauch (B) aus dem Gerät ziehen und am Behälter anschließen. Gewünschte Konzentration von Reinigungsmittel (B) am Dosierknopf einstellen¹⁾.
- E12.c Ansaugen aus 25 L Behälter: (nur für Version ohne Schlauchtrommel). Den markierten Bereich mit einem Messer entfernen, um die Befestigungspunkte freizulegen. Behälter an der Rückseite des Geräts befestigen. Schlauch (B) aus dem Gerät ziehen und am Behälter anschließen.
- E13. Reinigungsmittel einsetzen: Gewünschte Konzentration von Reinigungsmittel (A) oder (B) am Dosierknopf einstellen¹⁾. Objekt besprühen. Reinigungsmittel je nach Grad der Verschmutzung wirken lassen. Anschließend mit Hochdruckstrahl absprühen. Reinigungsmittel niemals auf dem Objekt trocknen lassen, da ansonsten die Oberfläche angegriffen werden kann.

F

Nach dem Einsatz des Geräts und vor der Lagerung

- F1. In den Kaltmodus schalten.
- F2. Im Kaltmodus betreiben, um das Gerät abzukühlen.
- F3. Reiniger abschalten. Schalter in Stellung „OFF“ stellen.
- F4. Versorgungsleitungen vom Gerät trennen.
- F5. Wasserhahn schließen.
- F6. Sprühpistole drücken, um den Druck abzulassen.
- F7. Die Sicherheitssperre am Sprühgriff verriegeln.

G

































- G1. **Lagerung des Reinigers bei unter 0°C:**
Wasserezulaufschlauch vom Reiniger entfernen. Sprührohr entfernen. Reiniger mit Hauptschalter in Stellung „Kaltwasser“ einschalten. Die Sprühpistole betätigen. Langsam Frostschutzmittel (etwa 5 Liter) in den Wasserbehälter (C) füllen. Das Gerät ist frostsicher, wenn das Frostschutzmittel aus der Sprühpistole austritt. Die Sicherheitssperre am Sprühgriff verriegeln. Gerät ausschalten Zur Vermeidung von Schäden das Reinigungsgerät vor der nächsten Inbetriebnahme zunächst in einem beheizten Raum zwischengelagern. Bei der erneuten Inbetriebnahme des Geräts kann das Frostschutzmittel gesammelt und erneut verwendet werden.
- G2. Filterglas neigen und abschrauben,¹⁾ entleeren, mit Frostschutzmittel auffüllen und wieder am Reiniger anbringen.

H



Wartung und Fehlerbehebung

- H1.a Wassereinfluss - Fingerfilter¹⁾: Schlauchtülle entfernen. Verschluss und Filter entfernen und mit Wasser reinigen.
- H1.b Wassereinfluss – großer Filter¹⁾: Glas nach außen neigen, abschrauben und mit Wasser reinigen.
- H2. Kraftstoff-Füllfilter: Der Filter kann mit den Fingern entfernt und mit sauberem Kraftstoff gespült werden.
- H3. Kraftstofffilter: Für Zugriff die Seitenklappe (A) öffnen. Schlauchklemmen öffnen und Kraftstofffilter (B) ersetzen. Die geltenden Vorschriften zur Entsorgung beachten. Für Ersatzfilter bitte an Nilfisk wenden.
- H4. Kraftstofftank: Ablassschraube entfernen und Kraftstoff in einen leeren Behälter ablassen. Mit sauberem Kraftstoff spülen. Die geltenden Vorschriften zur Entsorgung beachten.
- H5. Pumpenöl: Qualität des Pumpenöls prüfen: Farbe des Pumpenöls prüfen. Ist das Öl dunkelgrau oder weißlich gefärbt, an den Nilfisk Service wenden!
Die kalte Pumpe mit frischem Öl bis zur Markierung MAX auffüllen, falls erforderlich.
- H6. Flammensensor¹⁾: Sensor entfernen und mit einem weichen Tuch reinigen. Sicherstellen, dass der Sensor nach dem Wiedereinsetzen korrekt montiert wurde. Die Symbole müssen nach oben zeigen.

Anzeigen am Bedienfeld

Anzeigeleuchten	Anzeige ¹⁾	Ursache	Abhilfe
 Dauerlicht	0024	- Gerät betriebsbereit. - Beim Einschalten in den Kaltmodus wird der Stundenzähler einige Sekunden lang eingeblendet.	
 Blinklicht		- Wasserhahn geschlossen oder geringe Wassermenge. - Reinigungsbehälter ist leer. - Druckregler der Sicherheitssteuerung sperrt oder die VarioPress ¹⁾ Lanze ist auf geringe Wassermenge eingestellt. - Gerät verkalkt	- Wasserversorgung überprüfen. - Reinigungsmittel nachfüllen oder den Schalter für Reinigungsmittel auf „0“ stellen. - Einstellung der Sicherheitssteuerung/VarioPress ändern, um vollen Wasserdurchfluss zu ermöglichen. -  Nilfisk Service.
 Blinklicht	FLO	- Das Gerät läuft seit über 120 Sekunden ohne ausreichende Wasserversorgung. Das Gerät schaltet ab, um ein Überhitzen der Pumpe zu vermeiden.	- Falls der Fehler weiterhin auftritt, das Gerät neu starten  Nilfisk Service.
 Dauerlicht	FUE	- Nur noch wenig Brennstoff. - Betrieb mit Kaltwasser möglich.	- Brennstoffstand überprüfen und nachfüllen, nach 5 Sekunden Fehler zurücksetzen.
 Dauerlicht		- Füllstand Nilfisk AntiStone niedrig ¹⁾ . - Das Gerät kann weiterhin betrieben werden.	- Füllstand Nilfisk AntiStone überprüfen und nachfüllen.
 Dauerlicht  Dauerlicht		- Service-Intervall überschritten. - Das Gerät kann weiterhin betrieben werden.	-  Nilfisk Service.
 Dauerlicht  Blinklicht		- Service fällig nach 20 weiteren Betriebsstunden. - Das Gerät kann weiterhin betrieben werden.	-  Nilfisk Service.
 Dauerlicht	HOS	- Kessel ist überhitzt. Abgassensor (EXT-H) hat die Brennstoffzufuhr abgeschaltet. - Gerät ist verkalkt. - Kessel nicht gewartet. - Betrieb mit Kaltwasser möglich.	-  Nilfisk Service.
 Dauerlicht  Dauerlicht	LHE	- Flammensensor (B7) ist verrußt. - Fehler im Zünd- oder Brennstoffsystem. - Betrieb mit Kaltwasser möglich.	- Flammensensor (B7) reinigen. -  Nilfisk Service.
 Blinklicht  Blinklicht	LHL	- Kessel ist verrußt und benötigt Wartung. - Kessel ist mit Diesel gefüllt.	-  Nilfisk Service.
 Dauerlicht  Dauerlicht	HOP	- Motor ist überhitzt.	- Hauptschalter in Stellung „OFF“ bringen und Gerät abkühlen lassen. - Verlängerungskabel entfernen/abziehen. - Möglicher Phasenfehler. - Den elektrischen Anschluss überprüfen lassen. -  Nilfisk Service.
 Dauerlicht  Blinklicht	SEC	- Temperatursensor kurzgeschlossen.	-  Nilfisk Service.
 Blinklicht	SEO	- Temperatursensor ist nicht angeschlossen. - Betrieb mit Kaltwasser möglich.	
 Dauerlicht  Dauerlicht	FLF	- Fehlerhafter Durchflusssensor.	-  Nilfisk Service.
 Dauerlicht	POL	- Niedriger Ölstand der Pumpe. - Pumpe verliert Öl.	- Füllstand des Öls überprüfen und nachfüllen. -  Nilfisk Service.



Weitere Störungen

Störung	Ursache	Behebung
 leuchtet nicht auf	- Netzstecker nicht eingesteckt.	- Stecker in Steckdose stecken. - Ausreichende Absicherung prüfen (siehe Kapitel Technische Daten).
Druck zu niedrig	- Hochdruckdüse verschlissen. - Druckmengenregulierung bzw. VarioPress-Einrichtung ¹⁾ auf zu niedrigen Druck eingestellt.	- Hochdruckdüse erneuern. - Druckmengenregulierung am Regelsicherheitsblock in Richtung „+“ drehen bzw. VarioPress-Einrichtung) an der Pistole auf größere Wassermenge einstellen, (siehe Kapitel E10-11).
Gerät läuft unruhig	- Hochdruckpumpe saugt Luft aus leerem Reinigungsmittelbehälter.	- Reinigungsmittel-Dosierventil schließen. Sprührohr von Spritzpistole abnehmen. Spritzpistole betätigen und Gerät laufen lassen, bis die Luft aus dem System entwichen ist und die Pumpe wieder ruhig läuft..
Reinigungsmittel bleiben aus	- Reinigungsmittelbehälter leer. - Reinigungsmittelbehälter verschlammte. - Filter im Reinigungsmittelbehälter verschmutzt.	- Reinigungsmittelbehälter auffüllen. - Reinigungsmittelbehälter reinigen. - Filter ausbauen und reinigen.
Brenner verrußt	- Brennstoff verunreinigt. - Brenner verschmutzt oder nicht korrekt eingestellt.	-  Niifisk Service.

B6: Einstellung des Entkalkers

1. Gehäuse (A) öffnen. Die Wasserhärte messen oder beim Wasserversorger erfragen.							2. Den Einstellschalter (B) entsprechend der Wasserhärte einstellen			
mg/l	Grains	°dH	°e	°f	ppm Ca	Beschreibung	9-15 l/min	16-20 l/min	21-26 l/min	27-33 l/min
0,0-17	0-1	0-7	0-8,8	0-12,5	0-50	Weich	0	0	0	0
17-60	1,1-3,5					Leicht hart	0,5	1	2	2
60-128	3,6-7,5	7-14	8,8-17,5	12,5-25,1	51-150	Mittelhart	1	1,5	2,5	3
128-180	7,6-10,5	14-21	17,5-26,3	25,1-37,6	151-300	Hart	1,5	2	3	3,5
>180	>10,5	>21	>26,3	>37,6	>300	Sehr hart	2	3	3,5	4

Wartungsplan

	Wöchentlich	Bei Bedarf	Nach den ersten 50 Betriebsstunden	Wenn Serviceleuchte aufleuchtet.
Wasserfilter		●		
Einlassfilter des Brennstofftanks überprüfen und reinigen		●		
Internen Brennstofffilter überprüfen und reinigen		●		
Brennstofftank reinigen		●		
Die Nippel der Schnellkupplungen von Schlauch, Sprühpistole und Lanze schmieren	●			
Qualität des Pumpenöls überprüfen	●			
Pumpenöl wechseln			 Niifisk Service	 Niifisk Service

EU-Konformitätserklärung

Wir,
Niifisk A/S, Kornmarksvej 1, DK-2605 Broendby, DÄNEMARK

Erklären hiermit, dass die
Produkte: Hochdruckreiniger - Professionell – Mobil mit Warmwasserbetrieb

Beschreibung: 230V, 400-460V, 1~, 3~, 50 Hz, IPX5

Typ: MH 3M, MH 4M, MH 5M, MH 6P, MH 7P

den folgenden Normen entsprechen:

EN 60335-1:2012+A11:2014

EN 60335-2-79:2012

EN 55014-1:2006+A1:2009+A2:2011

EN 55014-2:2015

EN 61000-3-2:2014

EN 61000-3-11:2000

Entsprechend den Vorschriften von:

Maschinenrichtlinie 2006/42/EG

EMV-Richtlinie 2014/30/EG

Outdoorrichtlinie 2000/14/EG – Konformitätsbewertungsverfahren nach Anlage V.

- Gemessener Schallleistungspegel: 72-76 dB(A);

- Garantierter Schallleistungspegel: 88-92 dB(A)





















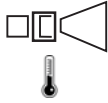

Hadsund, 28-09-2016























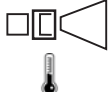

Anton Sørensen

Senior Vice President, Global R&D



















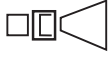
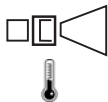

Specifications

			MH 3M-140/580 PA	MH 3M-100/600 PA	MH 3M-160/770 PA	MH 3M-160/770 PAX	MH 4M-100/680 PA	
1			EU	GB	EU	NO	GB	
2		V/ph/Hz	230/1/50	230/1/50	400/3/50	230/400/3/50	230/1/50	
3		A	C 16	C 13	C 16	C 25/16	C 13	
4		kW кВт	3.6	2.8	4.7	4.7	2.9	
5		A	16	12.5	8	14/8	13	
6		bar Бар 巴	140	100	160	160	100	
7		l/min л/мин 升/分钟	9.70	10.00	11.70	11.70	10.50	
8		bar Бар 巴	210	150	240	240	150	
9		l/min	9.70	10.00	12.80	12.80	11.30	
10			NT 0370	NT 0450	NT 0400	NT 0400	NT 0475	
11		°C	80/-	80/-	80/-	80/-	90/150	
12		°C	40					
13		bar Бар 巴	10					
14		mm 毫米	1010/700/1016					
15		kg кг	114	114	133	136	138	
16	 $K_{PA} = 3 \text{ dB}$	dB(A) дБ(A)	75.0	75.0	76.0	76.0	72.0	
17	 $K_{WA} = 3 \text{ dB}$	dB(A) дБ(A)	91.0	91.0	92.0	92.0	88.0	
18	 (ISO 5349 a _v)	m/s ² 米/秒 ²	2.8 ±1	2.7 ±1	2.9 ±1	2.9 ±1	2.7 ±1	
19		N	23.70	20.70	29.50	29.50	20.30	
20		L л 升	0.39 / SAE 80W-90	0.39 / SAE 80W-90	0.39 / SAE 80W-90	0.39 / SAE 80W-90	0.75 / Castrol Alphasyn T 150	
21		kW кВт	42	42	55	55	70	
22		L/л/升	15					
23		L/л/升	B: 10 L	B: 10 L	B: 10 L	B: 10 L	A: 10 L B: +	





















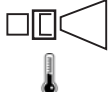

Specifications

			MH 4M- 100/680 PAX	MH 4M- 210/1000 PAX	MH 4M- 130/720 FA	MH 4M- 180/860 FAL	MH 4M- 180/860 FA
1			GB	EU	EU	EU	EU
2		V/ph/Hz	230/1/50	400/3/50	230/1/50	400/3/50	400/3/50
3		A	C 13	C 16	C 16	C 16	C 16
4		kW кВт	2.9	8.0	3.6	5.9	5.9
5		A	13	13.5	16	10	10
6		bar Бар 巴	100	210	130	180	180
7		l/min л/мин 升/分钟	10.50	15.70	11.00	13.20	13.20
8		bar Бар 巴	150	250	195	250	250
9		l/min	11.30	16.70	12.00	14.30	14.30
10			NT 0475	NT 0475	NT 0435	NT 0435	NT 0435
11		°C	90/150	90/150	90/150	90/150	90/150
12		°C	40				
13		bar Бар 巴	10				
14		mm 毫米	1010/700/1016				
15		kg кг	141	149	141	133	133
16	 K _{PA} = 3 dB	dB(A) дБ(A)	72.0	76.0	73.0	75.0	75.0
17	 K _{WA} = 3 dB	dB(A) дБ(A)	88.0	92.0	89.0	91.0	91.0
18	 (ISO 5349 a _v)	m/s ² 米/秒 ²	2.7 ±1	3.3 ±1	2.8 ±1	3.1 ±1	3.1 ±1
19		N	20.50	46.70	25.40	35.40	35.40
20		L л 升	0.75 / Castrol Alphasyn T 150	0.75 / Castrol Alphasyn T 150	0.75 / Castrol Alphasyn T 150	0.75 / Castrol Alphasyn T 150	0.75 / Castrol Alphasyn T 150
21		kW кВт	70	70	55	70	70
22		L/л/升	15				
23		L/л/升	A: 10 L B: +	A: 10 L B: +	A: 10 L B: +	B: 10 L	A: 10 L B: +

Specifications

			MH 4M-180/890 FA	MH 4M-180/890 FA	MH 4M-200/960 FA	MH 4M-200/960 FA	MH 4M-200/960 FAX
1			JP	JP	EU	NO	EU
2		V/ph/Hz	200/3/50	200/3/60	400/3/50	230/400/3/50	400/3/50
3		A	C 20	C 20	C 16	C 25/16	C 16
4		kW кВт	5.9	5.9	7.2	7.2	7.2
5		A	20	20	12	21/12	12
6		bar Бар 巴	180	180	200	200	200
7		l/min л/мин 升/分钟	13.80	13.80	14.80	14.80	14.80
8		bar Бар 巴	250	250	250	250	250
9		l/min	14.80	14.80	16.00	16.00	16.00
10			NT 0475	NT 0475	NT 0475	NT 0475	NT 0475
11		°C	90/150	90/150	90/150	90/150	90/150
12		°C	40				
13		bar Бар 巴	10				
14		mm 毫米	1010/700/1016				
15		kg кг	133	133	142	144	142
16	 K _{PA} = 3 dB	dB(A) дБ(A)	75.0	75.0	76.0	76.0	76.0
17	 K _{WA} = 3 dB	dB(A) дБ(A)	91.0	91.0	92.0	92.0	92.0
18	 (ISO 5349 a _h)	m/s ² 米/秒 ²	3.1 ±1	3.2 ±1	3.2 ±1	3.2 ±1	3.2 ±1
19		N	38.50	40.30	42.80	42.80	43.30
20		L л 升	0.75 / Castrol Alphasyn T 150	0.75 / Castrol Alphasyn T 150	0.75 / Castrol Alphasyn T 150	0.75 / Castrol Alphasyn T 150	0.75 / Castrol Alphasyn T 150
21		kW кВт	70	70	70	70	70
22		L/л/升	15				
23		L/л/升	A: 10 L B: +	A: 10 L B: +	A: 10 L B: +	A: 10 L B: +	A: 10 L B: +



















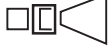
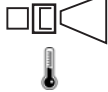

Specifications

			MH 4M- 200/960 FAX	MH 4M- 200/960 FA	MH 4M- 220/1000 FA	MH4M- 220/1000 FAXT
1			NO	EXP	EU	EU
2		V/ph/Hz	230/400/3/50	220-230/440- 460/3/60	400/3/50	400/3/50
3		A	C 25/16	C 25/16	C 16	C 16
4		kW кВт	7.2	7.2	7.2	7.2
5		A	21/12	21/12	14	14
6		bar Бар 巴	200	200	220	220
7		l/min л/мин 升/分钟	14.80	14.80	15.70	15.70
8		bar Бар 巴	250	250	250	250
9		l/min	16.00	16.00	16.70	16.70
10			NT 0475	NT 0475	NT 0475	NT 0475
11		°C	90/150	90/150	90/150	90/150
12		°C	40			
13		bar Бар 巴	10			
14		mm 毫米	1010/700/1016			
15		kg кг	147	142	142	149
16	 K _{PA} = 3 dB	dB(A) дБ(A)	76.0	76.0	76.0	76.0
17	 K _{WA} = 3 dB	dB(A) дБ(A)	92.0	92.0	92.0	92.0
18	 (ISO 5349 a _v)	m/s ² 米/秒 ²	3.2 ±1	3.2 ±1	3.4 ±1	3.4 ±1
19		N	43.30	42.90	47.20	47.30
20		L л 升	0.75 / Castrol Alphasyn T 150	0.75 / Castrol Alphasyn T 150	0.75 / Castrol Alphasyn T 150	0.75 / Castrol Alphasyn T 150
21		kW кВт	70	70	70	70
22		L/л/升	15			
23		L/л/升	A: 10 L B: +	A: 10 L B: +	A: 10 L B: +	A: 10 L B: +



















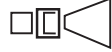
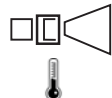

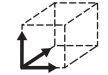
Specifications

			MH 5M-100/760 PA UK	MH 5M-100/760 PAX UK	MH 5M-200/960 FA	MH 5M-200/960 FAX	MH 5M-210/1100 FA
1			GB	GB	EU	EU	EU
2		V/ph/Hz	230/1/50	230/1/50	400/3/50	400/3/50	400/3/50
3		A	C 13	C 13	C 16	C 16	C 16
4		kW кВт	2.9	2.9	7.2	7.2	7.9
5		A	13	13	12	12	13.5
6		bar Бар 巴	100	100	200	200	210
7		l/min л/мин 升/分钟	11.30	11.30	14.80	14.80	17.50
8		bar Бар 巴	150	150	250	250	250
9		l/min	12.70	12.70	16.00	16.00	18.30
10			NT 0500	NT 0500	NT 0475	NT 0475	NT 0550
11		°C	90/150	90/150	90/150	90/150	90/150
12		°C	40				
13		bar Бар 巴	10				
14		mm 毫米	1188/ 700/ 1020				
15		kg кг	167	170	174	171	174
16	 K _{PA} = 3 dB	dB(A) дБ(А)	73.3	73.3	75.3	75.3	76.9
17	 K _{WA} = 3 dB	dB(A) дБ(А)	88.4	88.4	90.4	90.4	92.0
18	 (ISO 5349 a _v)	m/s ² 米/秒 ²	2.0 ±1	2.0 ±1	2.0 ±1	2.0 ±1	2.0 ±1
19		N	23.60	23.80	42.70	43.20	52.80
20		L л 升	0.75 / Castrol Alphasyn T 150	0.75 / Castrol Alphasyn T 150	0.75 / Castrol Alphasyn T 150	0.75 / Castrol Alphasyn T 150	0.75 / Castrol Alphasyn T 150
21		kW кВт	70	70	80	80	90
22		L/л/升	30				
23		L/л/升	A: 10 L B: 10 L	A: 10 L B: 10 L	A: 10 L B: 10 L	A: 10 L B: 10 L	A: 10 L B: 10 L

Specifications

			MH 5M-210/1100 FAX	MH 5M-210/1100 FA	MH 5M-210/1100 FAX	MH 5M-210/1100 PAX	MH 5M-210/1100 FA
1			EU	NO	NO	EU	EXP
2		V/ph/Hz	400/3/50	230/400/3/50	230/400/3/50	400/3/50	220-230/440-460/3/60
3		A	C 16	C 25/16	C 25/16	C 16	C 25/16
4		kW кВт	7.9	7.9	7.9	7.9	7.9
5		A	13.5	24/13.5	24/13.5	13.5	24/13.5
6		bar Бар 巴	210	210	210	210	210
7		l/min л/мин 升/分钟	17.50	17.50	17.50	17.50	17.50
8		bar Бар 巴	250	250	250	250	250
9		l/min	18.30	18.30	18.30	18.30	18.30
10			NT 0550	NT 0550	NT 0550	NT 0550	NT 0550
11		°C	90/150	90/150	90/150	90/150	90/150
12		°C	40				
13		bar Бар 巴	10				
14		mm 毫米	1188/ 700/ 1020				
15		kg кг	179	174	180	179	180
16	 $K_{PA} = 3 \text{ dB}$	dB(A) дБ(A)	76.9	76.9	76.9	76.9	76.9
17	 $K_{WA} = 3 \text{ dB}$	dB(A) дБ(A)	92.0	92.0	92.0	92.0	92.0
18	 (ISO 5349 a _v)	m/s ² 米/秒 ²	2.0 ±1	2.0 ±1	2.0 ±1	2.0 ±1	2.0 ±1
19		N	53.60	52.80	53.60	52.40	52.80
20		L л 升	0.75 / Castrol Alphasyn T 150	0.75 / Castrol Alphasyn T 150	0.75 / Castrol Alphasyn T 150	0.75 / Castrol Alphasyn T 150	0.75 / Castrol Alphasyn T 150
21		kW кВт	90	90	90	90	90
22		L/л/升	30				
23		L/л/升	A: 10 L B: 10 L	A: 10 L B: 10 L	A: 10 L B: 10 L	A: 10 L B: 10 L	A: 10 L B: 10 L



















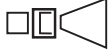
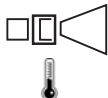

Specifications



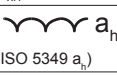



			MH 6P-210/1100 FA	MH 6P-210/1100 FA	MH 6P-175/1250 FA EU	MH 6P-175/1250 FAX EU	MH 6P-200/1300 FA
1			JP	JP	EU	EU	EU
2		V/ph/Hz	200/3/50	200/3/60	400/3/50	400/3/50	400/3/50
3		A	C 30	C 30	C 16	C 16	C 16
4		kW кВт	8.8	8.7	8.5	8.5	9.1
5		A	29	28	14.5	14.5	15.5
6		bar Бар 巴	210	210	175	175	200
7		l/min л/мин 升/分钟	17.50	17.50	19.20	19.20	20.00
8		bar Бар 巴	250	250	250	250	250
9		l/min	18.30	18.30	20.80	20.80	21.70
10			NT 0550	NT 0550	NT 0750	NT 0750	NT 0680
11		°C	90/150	90/150	90/150	90/150	90/150
12		°C	40				
13		bar Бар 巴	10				
14		mm 毫米	1188/ 700/ 1020	1188/ 700/ 1020	1188/ 700/ 1020	1188/ 700/ 1020	1188/ 700/ 1045
15		kg кг	179	179	180	188	198
16	 $K_{PA} = 3 \text{ dB}$	dB(A) дБ(A)	76.9	76.9	78.8	78.8	78.8
17	 $K_{WA} = 3 \text{ dB}$	dB(A) дБ(A)	92.0	92.0	91.2	91.2	92.2
18	 (ISO 5349 a _v)	m/s ² 米/秒 ²	2.6 ±1	2.6 ±1	2.6 ±1	2.6 ±1	2.6 ±1
19		N	52.80	52.80	55.40	56.60	59.50
20		L л 升	0.95 / Castrol Alphasyn T 150	0.95 / Castrol Alphasyn T 150	0.95 / Castrol Alphasyn T 150	0.95 / Castrol Alphasyn T 150	0.95 / Castrol Alphasyn T 150
21		kW кВт	90	90	90	90	115
22		L/л/升	30				
23		L/л/升	A: 10 L B: 10 L	A: 10 L B: 10 L	A: 10 L B: 10 L	A: 10 L B: 10 L	A: 10 L B: 10 L





Specifications





			MH 6P- 200/1300 FA	MH 6P- 200/1300 FAX	MH 6P- 195/1350 FA EXPT	MH 7P- 180/1260 FA	MH 7P- 180/1260 FA	
1			NO	EU	EXP	EU	NO	
2		V/ph/Hz	230/400/3/50	400/3/50	220-230/440- 460/400/ 3/60	400/3/50	230/400/3/60	
3		A	C 25/16	C 16	C 25/16	C 16	C 25/16	
4		kW кВт	9.1	9.2	9.2	7.6	7.7	
5		A	25/14	15.7	25/13	13.5	24/14	
6		bar Бар 巴	200	200	195	180	180	
7		l/min л/мин 升/分钟	20.00	20.00	20. 80	19.50	19.50	
8		bar Бар 巴	250	250	250	250	250	
9		l/min	21.70	21.70	22.50	21.00	21.00	
10			NT 0680	NT 0680	NT 0700	NT 0680	NT 0680	
11		°C	90/150	90/150	90/150	90/150	90/150	
12		°C	40					
13		bar Бар 巴	10					
14		mm 毫米	1188/ 700/ 1045	1188/ 700/ 1045	1188/ 700/ 1045	1188/ 700/ 1045	1188/ 700/ 1045	
15		kg кг	207	207	216	195	199	
16		dB(A) дБ(А)	78.8	78.8	78.8	76.5	76.5	
17		dB(A) дБ(А)	92.2	92.2	92.2	91.6	91.6	
18		m/s ² 米/秒 ²	2.6 ±1	2.6 ±1	2.6 ±1	3.4 ±1	3.4 ±1	
19		N	59.70	60.20	61.20	55.40	55.40	
20		L л 升	0.95 / Castrol Alphasyn T 150	0.95 / Castrol Alphasyn T 150	0.95 / Castrol Alphasyn T 150	1.10 / Castrol Alphasyn T 150	1.10 / Castrol Alphasyn T 150	
21		kW кВт	115	115	115	115	115	
22		L/л/升	30					
23		L/л/升	A: 10 L B: 10 L	A: 10 L B: 10 L	A: 10 L B: 10 L	A: 10 L B: 10 L	A: 10 L B: 10 L	



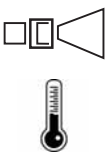



Specifications



			MH 7P-180/1260 FAX	MH 7P-180/1260 FAX	MH 7P-180/1260 FA	MH 7P-180/1260 FA
1			EU	NO	JP	JP
2		V/ph/Hz	400/3/50	230/400/3/50	200/3/50	200/3/60
3		A	C 16	C 25/16	C 20	C 20
4		kW кВт	7.6	7.7	7.7	7.3
5		A	13.5	25/14.5	27.5	27.5
6		bar Бар 巴	180	180	180	180
7		l/min л/мин 升/分钟	19.50	19.50	19.50	19.50
8		bar Бар 巴	250	250	250	250
9		l/min	21.00	21.00	21.00	21.00
10			NT 0680	NT 0680	NT 0680	NT 0680
11		°C	90/150	90/150	90/150	90/150
12		°C	40			
13		bar Бар 巴	10			
14		mm 毫米	1188/ 700/ 1045	1188/ 700/ 1045	1188/ 700/ 1045	1188/ 700/ 1045
15		kg кг	204	208	195	195
16	 $K_{PA} = 3 \text{ dB}$	dB(A) дБ(A)	76.5	76.5	76.5	76.5
17	 $K_{WA} = 3 \text{ dB}$	dB(A) дБ(A)	91.6	91.6	91.6	91.6
18	 (ISO 5349 a _v)	m/s ² 米/秒 ²	3.4 ±1	3.4 ±1	3.4 ±1	3.4 ±1
19		N	56.00	56.00	55.80	55.20
20		L л 升	1.10 / Castrol Alphasyn T 150	1.10 / Castrol Alphasyn T 150	1.10 / Castrol Alphasyn T 150	1.10 / Castrol Alphasyn T 150
21		kW кВт	115	115	115	115
22		L/л/升	30			
23		L/л/升	A: 10 L B: 10 L	A: 10 L B: 10 L	A: 10 L B: 10 L	A: 10 L B: 10 L

1			EN: Country variant. DE: Ländervarianten. FR: Selon le pays. NL: Nationale variant. IT: Variante per il Paese. NO: Variant i ulike land. SV: Landsvariant. DA: Landespecifik variant. FI: Maakohtainen vaihtelu. ES: Dependé del país. PT: Variante do país. EL: Έκδοση χώρας. TR: Ülkedeki model. SL: Jezikovna različica. HR: Ovisno o zemlji. SK: Vrsta ulja. CS: Varianta země. PL: Wersja dla kraju. HU: Országfüggő modellváltozatok. RO: Varianta țării. BG: Вариант за страната. RU: Региональное исполнение. ET: Riigi variant. LV: Valsts versija. LT: Šaliai skirtas variantas. JA: 国による相違。 ZH: 不同国家 KO: 국가별 모델. TH: แดกต่างกันไปตามประเทศ MS: Variasi negara.
2		V/ ph/ Hz	EN: Possible voltage. DE: Mögliche Spannung. FR: Tension autorisée. NL: Mogelijke spanning. IT: Possibile voltaggio. NO: Mulig spenning. SV: Möjlig spänning. DA: Spænding. FI: Mahdollinen jännite, V/vaiheluku/taajuus. ES: Tensión admitida. PT: Tensão possível. EL: Πιθανή τάση, V/ph/Frez. TR: Olası voltaj, V/Faz/Frekans. SL: Morebitna napetost. HR: Mogući napon. SK: Možné napätie. CS: Možné napětí. PL: Dopuszczalne napięcie, V/fazy/częst. HU: Tápészültség, V/fázis/frekv. RO: Tensiune posibilă, V/fază/Frecv. BG: Възможно напрежение. RU: Напряжение, В/ф./част. В/ф./Гц. ET: Võimalik pinge, V/faas/sagedus. LV: iespējams spriegums. LT: Galima įtampa V / F / Frez. JA: 電圧。 ZH: 可能电压 (V/ph/Frez) KO: 허용 전압, 볼트/상/헤르츠. TH: แรงดันไฟฟ้าที่สามารถใช้ได้ MS: Kemungkinan voltan.
3		A	EN: Fuse. DE: Sicherung. FR: Fusible. NL: Zekering. IT: Fusibile. NO: Sikring. SV: Säkring. DA: Sikring. FI: Sulake. ES: Fusible. PT: Fusível. EL: Ασφάλεια. TR: Sigorta. SL: Varovalka HR: Osigurač SK: Poistka CS: Pojistka. PL: Bezpiecznik. HU: Biztosíték. RO: Siguranță. BG: Предпазител RU: Предохранитель. ET: Kaitse. LV: Drošinātājs. LT: Saugiklis. JA: ヒューズ ZH: 保险丝 KO: 퓨즈. TH: ฟิวส์ MS: Fius
4		kW kBT	EN: Power rating. DE: Nennleistung. FR: Puissance nominale. NL: Nominiaal vermogen. IT: Corrente nominale. NO: Nominell effekt. SV: Märkeffekt. DA: Nominel effekt. FI: Tehontarve. ES: Potencia nominal. PT: Classificação de potência. EL: Ονομαστική ισχύς. TR: Elektrik değerleri. SL: Moč. HR: Označka napona. SK: Stanovenie výkonu. CS: Jmenovitý výkon. PL: Moc znamionowa. HU: Névleges teljesítmény. RO: Putere nominală. BG: Мощност. RU: Номинальная мощность кВт. ET: Vooluühik. LV: Nominālā jauda. LT: Galia. JA: 定格電力。 ZH: 额定功率 KO: 전원 등급. TH: อัตรากำลังไฟ MS: Penarafan kuasa.
5		A	EN: Current consumption. DE: Aktueller Verbrauch. FR: Consommation de courant. NL: Huidig verbruik. IT: Consumo di corrente. NO: Strømforbruk. SV: Strömförbrukning. DA: Strømforbrug. FI: Nykyinen kulutus. ES: Consumo actual. PT: Consumo de corrente. EL: Κατανάλωση ρεύματος. TR: Geçerli tüketim. SL: Poraba električne energije. HR: Potrošnja struje. SK: Aktuálna spotreba. CS: Odběr proudu. PL: Pobór prądu. HU: Áramfelvétel. RO: Consum de curent. BG: Консумация на електроенергия. RU: Текущий расход. ET: Praegune tarbimine. LV: Strāvas patēriņš. LT: Esamas suvartojimas. JA: 消費電流。 ZH: 电流消耗。 KO: 소비 전류. TH: กำลังไฟฟ้า MS: Penggunaan semasa.
6		bar Бар 巴	EN: Working pressure. DE: Arbeitsdruck. FR: Pression de service. NL: Werkdruk. IT: Pressione di esercizio. NO: Arbeidstrykk. SV: Arbetstryck. DA: Arbejdstryk. FI: Työpaine. ES: Presión de trabajo. PT: Pressão de trabalho. EL: Πίεση λειτουργίας. TR: Çalışma basıncı. SL: Delovni tlak. HR: Radni tlak. SK: Pracovní tlak. CS: Provozní tlak. PL: Ciśnienie robocze. HU: Üzemnyomás. RO: Presiune de lucru. BG: Работно налягане. RU: Рабочее давление. ET: Töösurve. LV: Darba spiediens. LT: Darbinis slėgis. JA: 動作圧力。 ZH: 工作压力 KO: 작업 압력. TH: แรงดันขณะใช้งาน MS: Tekanan kerja

7		l/min л/МИН 升/分钟	EN: Water flow. DE: Wasserdurchsatz. FR: Débit d'eau. NL: Waterdoorstroming. IT: Flusso dell'acqua. NO: Vanntilførsel. SV: Vattenflöde. DA: Vandmængde. FI: Vedenvirtaus. ES: Flujo de agua. PT: Fluxo de água. EL: Ποή νερού. TR: Su akışı. SL: Pretok vode. HR: Regulacija protoka vode. SK: Prietok vody. CS: Průtok vody. PL: Przepływ wody. HU: Vízátfolyás. RO: Debit apă. BG: Воден поток. RU: Расход воды. ET: Veevool. LV: Ūdens plūsma. LT: Vandens srautas. JA: 流水 ZH: 水流量 KO: 급수량 TH: การไหลของน้ำ MS: Aliran air.
8		bar Бар 巴	EN: Max. water pressure. DE: Max Wasserdruck. FR: Pression d'eau maximale. NL: Max. waterdruk. IT: Max. pressione dell'acqua. NO: Maks. vanntrykk. SV: Max vattentryck. DA: Max. vandtryk. FI: Suurin vedenpaine. ES: Presión máxima de entrada del agua. PT: Pressão máxima de água. EL: Μέγ. πίεση νερού. TR: Maks. su basıncı. SL: Najv. vodni tlak. HR: Maksimalni tlak vode. SK: Maximálny tlak vody. CS: Max. tlak vody. PL: Maks. ciśnienie wody. HU: Max. víznyomás. RO: Presiune max. apă. BG: Макс. налягане на водата. RU: Макс. давление воды. ET: Max veesurve. LV: Maks. ūdens spiediens. LT: Maks. vandens slėgis. JA: 最高水圧 ZH: 最大水压. KO: 최대 수압. TH: ความดันน้ำสูงสุด MS: Tekanan air maksimum.
9		l/min л/МИН 升/分钟	EN: Water flow DE: Wasserdurchsatz. FR: Débit d'eau. NL: Waterdoorstroming. IT: Flusso dell'acqua. NO: Vanntilførsel. SV: Vattenflöde. DA: Vandmængde. FI: Vedevirtaus. ES: Flujo de agua. PT: Fluxo de água. EL: Ποή νερού. TR: Su akışı. SL: Pretok vode. HR: Protok vode. SK: Prietok vody. CS: Průtok vody. PL: Przepływ wody. HU: Vízátfolyás. RO: Debit apă. BG: Воден поток. RU: Расход воды. ET: Veevool. LV: Ūdens plūsma. LT: Vandens srautas. JA: 流水. ZH: 水流量 KO: 급수량 TH: การไหลของน้ำ MS: Aliran air.
10			EN: High pressure nozzle DE: Hochdruckdüse. FR: Buse haute pression. NL: Hogedruksproeier. IT: Ugello alta pressione. NO: Høytrykksmunnstykke. SV: Högtrycksmunstycke. DA: Højtryksdyse. FI: Korkeapainesuutin. ES: Boquilla de alta presión. PT: Bocal de alta pressão. EL: Ακροφύσιο υψηλής πίεσης. TR: Yüksek basınçlı ağız. SL: Šoba za visoki pritisk. HR: Visokotlačna mlaznica. SK: Vysokotlaková hubica. CS: Vysokotlaková tryska. PL: Dysza wysokociśnieniowa. HU: Nagynyomású fúvóka. RO: Duză de înaltă presiune. BG: Дюза за високо налягане. RU: Сопло высокого давления. ET: Kõrgsurve otsak. LV: Augstspiediena sprausla. LT: Aukšto slėgio purkštukas. JA: 高压カノズル. ZH: 高压喷嘴. KO: 고압 노즐 TH: หัวฉีดแรงดันสูง MS: Nozel tekanan tinggi.
11		°C	EN: Water Temperature. DE: Wasser temperatur. FR: d'eau température. NL: Water temperatuur. IT: dell'acqua temperatura. NO: Vann temperatur. SV: Vatten temperatur. DA: Vandtemperatur. FI: Veden lämpötila. ES: agua temperatura. PT: água temperatura. EL: νερού θερμοκρασία. TR: Su sıcaklık. SL: vode temperatura. HR: vode temperatura. SK: vody teplota. CS: vody teplota. PL: wody temperatura. HU: Viz hőmérséklet. RO: apă temperatură. BG: Воден температура. RU: воды температура. ET: Vee temperatuur. LV: Ūdens temperatūra. LT: Vandens temperatūra. JA: 水温度. ZH: 水温度. KO: 물 온도. TH: น้ำอุณหภูมิที่ไซ MS: Air Suhu yang.

12		°C	<p>EN: Max water inlet temperature, Intake-Pressure operation. DE: Max Wassereinlassstemperatur - Druckbetrieb. FR: Température max. de l'entrée d'eau en mode admission/pression. NL: Max. Waterinlaattemperatuur Inlaat-Tijdens. Bedrijf. IT: Temperatura max. alimentazione acqua Funzionamento a ingressopressione. NO: Maks. temperatur vanninntak, Inntakstrykk drift. SV: Max ingående vattentemperatur inlopps-tryckdrift. DA: Maks. vandtilgangstemperatur, tilgangstrykdrift. FI: Tuloveden suurin lämpötila, käytettäessä painepesurina. ES: Temperatura y presión máxima de entrada del agua. PT: Temperatura máxima de entrada de água, Funcionamento da pressão de entrada. EL: Μεγ. θερμοκρασία εισόδου νερού-λειτουργίας πίεσης. TR: Maks. su girişi sıcaklığı Emme-Basınçlı çalışma. SL: Najv. vstopna temperatura vode, vstopni tlak pri delovanju. HR: Maks. temperatura ulazne vode, tlak pri usisavanju. SK: Max. vstupná teplota vody, Prevádzka v nasávacom režime pod tlakom. CS: Max. teplota vody na vstupu, provozní sací tlak. PL: Maks. temperatura na dopływie wody z instalacji wodociągowej. HU: Max. bemenő vízhőmérséklet Szívónyomásos üzem. RO: Temperatura max. de admisie apă în cazul alimentării de la robinet. BG: Макс. температура на входящата вода – работа в режим на засмукване. RU: Макс. температура воды на входе (всасывание/подача под давлением). ET: Max vee sisselasketemperatuur Sissevõturihk töö ajal. LV: Maks. ūdens ieplūdes temperatūra ieplūdes-spiediena darbībā. LT: Didžiausia vandens paėmimo temperatūra, veikimas esant jėjimo slėgiui. JA: 最高流入水温度、吸気圧力動作。 ZH: 进水压力操作时的最高进水水温 KO: 최대 급수 온도 주입/압력 작동. TH: อุณหภูมิน้ำเข้าสูงสุด ความดันในการใช้งานบริเวณทางเข้า MS: Suhu maksimum air masuk, Kemasukan-Operasi tekanan.</p>
13		bar Бар 巴	<p>EN: Max. water inlet pressure. DE: Max. Wassereinlassdruck. FR: d'eau en mode admission/pression. NL: Max. waterinlaatdruk. IT: Pressione max. alimentazione acqua. NO: Maks. trykk vanninntak. SV: Max tryck för vatteninlopp. DA: Maks. Vandtilgangstryk. FI: Tuloveden suurin paine. ES: Presión máxima de entrada del agua. PT: Pressão máxima de entrada de água. EL: Μεγ. πίεση εισόδου νερού. TR: Maks. su girişi basıncı. SL: Najv. tlak dovoda vode. HR: Maks. tlak ulazne vode. SK: Max. vstupný tlak vody. CS: Max. tlak vody na vstupu. PL: Maks. ciśnienie na dopływie wody. HU: Max. bemenő nyomás. RO: Presiunea max. de alimentare cu apă. BG: Макс. налягане на входяща вода. RU: Макс. давление воды на входе. ET: Maks vee sissevoolusurve. LV: Maks. ūdens spiediens. LT: Didžiausias vandens paėmimo slėgis. JA: 最高流入水圧。 ZH: 最大进水压力 KO: 최고 급수 압력. TH: ความดันน้ำเข้าสูงสุด MS: Tekanan maksimum air masuk.</p>
14		mm 毫米	<p>EN: Dimensions LxWxH. DE: Masse LxBxH. FR: Dimensions l x p x h. NL: Afmetingen LxBxH. IT: Dimensioni, lun. x larg. x alt. NO: Mål LxBxH. SV: Dimensioner LxBxH. DA: Mål LxBxH. FI: Mitat, PxLxK. ES: Dimensiones l x a x al. PT: Dimensões, C x L x A. EL: Διαστάσεις, Μ x Π x Υ. TR: Boyutlar, u x g x y. SL: Mere D x Š x V. HR: Dimenzije DxŠxV. SK: Rozmery D x Š x V. CS: Rozměry d x š x v. PL: Wymiary długość x szer. x wys. HU: Méretek H x Sz x M. RO: Dimensiuni. L x l x î. BG: Размери Д x Ш x В. RU: Размеры, Дл. x Шир. x Выс. ET: Mõõtmed p x l x k. LV: Izmēri G x P x A. LT: Matmenys (l x p x a). JA: 外形寸法長さx幅x高さ。 ZH: 尺寸 (长 x 宽 x 高) 毫米 KO: 크기 (l x w x h). TH: ขนาด ยาว x กว้าง x สูง MS: Dimensi LxWxH.</p>
15		kg кг	<p>EN: Weight. DE: Gewicht. FR: Poids du nettoyeur. NL: Gewicht van de hogedrukreiniger. IT: Peso dell'idropulitrice. NO: Vekt høytrykksvasker. SV: Maskinens vikt. DA: Vægt. FI: Pelkän painepesurin paino. ES: Peso del limpiador. PT: Peso da máquina de limpeza. EL: Βάρος μηχανήματος καθαρισμού. TR: Temizlik makinesinin yüksekliği. SL: Masa. HR: Težina. SK: Hmotnosť. CS: Hmotnost čisticího stroje. PL: Ciężar myjki. HU: Tisztítógép tömege. RO: Greutatea aparatului. BG: Тегло. RU: Вес моечной машины. ET: Pesuri kaal. LV: Tīrītāja svars. LT: Valymo įrenginio svoris. JA: 重量。 ZH: 清洗机重量 KO: 세척기 무게. TH: น้ำหนัก MS: Berat.</p>

16	 L _{PA} (IEC 60335-2-79)	dB(A) дБ(А)	EN: Sound pressure level L _{PA} DE: Schalldruckpegel FR: Niveau de pression acoustique NL: Geluidsdrukniveau IT: Livello pressione sonora NO: Lydtrykknivå SV: Ljudtrycksnivå DA: Lydtryksniveau FI: Äänenpainetaso ES: Nivel de presión sonora PT: Nível de pressão acústica EL: Επίπεδο πίεσης ήχου TR: Göre ses basıncı seviyesi SL: Raven zvočnega tlaka. HR: Razina zvučnog tlaka. SK: Hladina zvukového. CS: Hladina akustického tlaku PL: Poziom ciśnienia akustycznego HU: Hangnyomásszint RO: Nivel de presiune acustică BG: Ниво на звуково налягане RU: Уровень шума ET: Helisurve tase LV: Akustiskā spiediena līmenis LT: Garso slėgio lygis JA: 音圧レベル ZH: 声压级 KO: 음압 레벨 TH: ระดับความดันเสียง MS: Tahap tekanan bunyi
17	 L _{WA} (IEC 60335-2-79)	dB(A) дБ(А)	EN: Sound power level L _{WA} DE: Schallleistungspegel FR: Niveau de puissance acoustique NL: Geluidsvermogeniveau IT: Livello potenza sonora NO: Lydeffektnivå SV: Ljudeffektnivå DA: Lydeffektniveau FI: Äänen tehotaaso ES: Potencia acústica PT: Nível de potência acústica EL: Επίπεδο ισχύος ήχου TR: Göre ses basıncı seviyesi SL: Raven moči zvoka. HR: Razina jakosti. SK: Hladina zvukového výkonu. CS: Hladina akustického výkonu PL: Poziom mocy akustycznej HU: Hangteljesítmény szint RO: Nivelul de putere acustică BG: Ниво на звукова мощност RU: Уровень звуковой мощности ET: Helivõimsuse tase LV: Akustiskās jaudas līmenis LT: Garso galios lygis JA: 音響パワーレベル ZH: 声功率级 KO: 소음 레벨 TH: ระดับกำลังเสียง MS: Tahap kuasa bunyi
18	 a _h (ISO 5349 a _h)	m/s ² 米/秒 ²	EN: Vibration. DE: Vibrationen FR: Vibration NL: Vibratie IT: Vibrazioni NO: Vibrasjoner SV: Vibration DA: Vibration FI: Tärinäarvot ES: Vibración PT: Vibração EL: Δόνηση TR: Titreşimi SL: Vibracije. HR: Vibracije. SK: Vibrácie. CS: Vibrace PL: Drgania HU: Vibráció RO: Vibrații BG: Вибрации. RU: Вибрация ET: vibratsioon LV: vibrācija LT: Vibracijos JA: 振動. ZH: 振动 KO: 진동 TH: แรงสั่นสะเทือน MS: Getaran.
19		N	EN: Recoil forces, lance. DE: Rückstoßkraft, Sprühhrohr FR: Forces de recul, lance NL: Terugslagkracht, lans IT: Forze di rinculo, lancia NO: Rekylkraft, lanse SV: Rekylkraft, spolrör DA: Rekylkraft, dyserør FI: Rekyylivoimat, suutin ES: Fuerzas de retroceso, lanza PT: Forças de retrocesso, lança EL: Δυνάμεις οπισθοδρόμησης, διάταξη ψεκασμού χη. TR: Sarmal kuvvetler, boru SL: Povratne sile, šoba. HR: Trzajne sile, mlaznica. SK: Spätňý odraz, štandardná striekacia rúra. CS: Síly zpětného rázu, násadec PL: Siły odrzutu, lanca HU: Visszaható erő, szórócső RO: Forțe de recul, tijă BG: Сили на откат, крайник. RU: Сила отдачи (распылитель). ET: Tagasilöögi jõud, otsik LV: Atsitiena spēks, smidzinātājs LT: Atatrankos jėga, antgalis, JA: 反跳力、ランス。 ZH: 反冲力 (喷杆) KO: 반동력, 랜스 TH: แรงสะท้อน ถอยหลัง, ปลાયทอ MS: Kuasa sentakan, lans.
20	 TYPE	L л 升	EN: Oil quantity, type. DE: Ölmenge, typ. FR: Quantité d'huile, type. NL: Hoeveelheid olie, type. IT: Quantità di olio, tipo. NO: Oljemengde, type. SV: Oljemängd, typ. DA: Oliemængde, type. FI: Öljymäärä, tyyppi. ES: Cantidad de aceite, tipo. PT: Quantidade de óleo, tipo. EL: Ποσότητα λαδιού, τύπος. TR: Yağ miktarı, tipi. SL: Količina olja, vrsta. HR: Količina ulja, vrsta. SK: Množstvo oleja, typ. CS: Množství oleje, typ. PL: Mnożstwo oleje, typ. HU: Olajmennyiség, típusa. RO: Cantitate de ulei, tip. BG: Количество масло, Тип. RU: Количество масла, Тип. ET: õli kogus, tüüp. LV: Eļļas daudzums, tips. LT: alvos kiekis, tipas. JA: オイル量種類。 ZH: 猴祇 类型 KO: 오일량, 유형. TH: ปริมาณน้ำมันเครื่อง ประเภท MS: Kuantiti minyak, jenis.
21		kW кВт	EN: Heating capacity. DE: Heizleistung. FR: Puissance calorifique. NL: Verwarmingscapaciteit. IT: Potenza termica. NO: Varmekapasitet. SV: Värmeeffekt. DA: Opvarmningskapacitet. FI: Lämmitysteho. ES: Capacidad de calentamiento. PT: Capacidade de aquecimento. EL: Θερμική απόδοση. TR: Isıtma kapasitesi. SL: Zmogljivost gretja. HR: Kapacitet grijanja. SK: Ohrevný výkon. CS: Tepelný výkon. PL: Moc grzewcza. HU: Fűtőteljesítmény. RO: Capacitate de încălzire. BG: Отоплителна мощност. RU: Мощность нагрева. ET: Küttevõimsus. LV: Sildīšanas jauda. LT: Šildymo galia. JA: 加熱能力。 ZH: 热容量。 KO: 가열 용량. TH: ความจุความร้อน MS: Kapasiti pemanasan.

22		L л 升	<p>EN: Fuel tank. DE: Kraftstofftank. FR: Réservoir de carburant. NL: Brandstoftank. IT: Serbatoio carburante. NO: Drivstoffbeholder. SV: Bränsletank. DA: Brændstofftank. FI: Polttoainesäiliö. ES: Depósito de combustible. PT: Depósito de combustível. EL: Πεζερβουάρ καυσίμου. TR: Yakıt deposu. SL: Posoda za gorivo. HR: Spremnik goriva. SK: Palivová nádrž. CS: Palivová nádrž. PL: Zbiornik paliwa. HU: Üzemanyagtartály. RO: Rezervor de combustibil. BG: Резервоар за гориво. RU: Топливный бак. ET: Kütusepaak. LV: Degvielas tvertne. LT: Kuro bakas. JA: 燃料タンク。 ZH: 油箱。 KO: 연료 탱크. TH: ถังเชื้อเพลิง MS: Tangki bahan api.</p>
23		L л 升	<p>EN: Detergent tank A/B. DE: Reinigungsmittelbehälter A/B. FR: Réservoir de détergent A/B. NL: Reinigingsmiddeltank A/B. IT: Serbatoio del detergente A/B. NO: Vaskemiddelbeholder A/B. SV: Tank för rengöringsmedel A/B. DA: Rengøringsmiddeltank A/B. FI: Pesuainesäiliö A/B. ES: Depósito de detergente A/B. PT: Depósito de detergente A/B. EL: Πεζερβουάρ απορρυπαντικών A/B. TR: Deterjan deposu A/B. SL: Posoda za detergent A/B. HR: Spremnik za deterđent A/B. SK: Nádoaba na čistiaci prostriedok A/B. CS: Nádrž na čistící prostředek A/B. PL: Zbiornik na plyn do czyszczenia A/B. HU: Tisztítószerartály A/B. RO: Rezervor de detergent A/B. BG: Резервоар за почистващ препарат A/B. RU: Бак с моющим средством A/B. ET: Puhastusvahendi paak A/B. LV: Mazgāšanas līdzekļu tvertne A/B. LT: Ploviklio bakas A/B. JA: 洗剤タンクA/B。 ZH: 洗涤剂箱 A/B。 KO: 세제 탱크 A/B. TH: ถังสารซักฟอก A/B MS: Tangki detergent A/B.</p>
24	<p>EN: Specifications and details are subject to change without prior notice. DE: Technische Daten und Details des Geräts können sich ohne vorherige Ankündigung ändern. FR: Ces spécifications et détails sont susceptibles d'être modifiés sans préavis. NL: Specificaties en details kunnen zonder voorafgaande waarschuwing worden gewijzigd. IT: Specifiche e dettagli sono soggetti a modifiche senza preavviso. NO: Spesifikasjonene og detaljene er gjenstand for endringer uten forutgående varsel. SV: Specifikationer och information kan ändras utan föregående meddelande. DA: Ret til ændringer i konstruktion og specifikationer forbeholdes. FI: Rakenteeseen ja teknisiin tietoihin voidaan tehdä muutoksia ilmoittamatta niistä ennalta. ES: Las especificaciones y los datos están sujetos a cambios sin previo aviso. PT: As especificações e os detalhes estão sujeitos a alterações sem aviso prévio. EL: Τα τεχνικά χαρακτηριστικά και οι λεπτομέρειες υπόκεινται σε αλλαγές χωρίς προηγούμενη ειδοποίηση. TR: Özellikler ve ayrıntılar, önceden haber verilmeden değiştirilebilir. SL: Tehnični podatki in podrobnosti se lahko spremenijo brez predhodnega obvestila. HR: Specifikacije i detalji mogu se mijenjati bez prethodne najave. SK: Špecifikácie a podrobnosti sa môžu meniť bez predchádzajúceho upozornenia. CS: Technické údaje a detaily mohou být změněny i bez předchozího upozornění. PL: Specyfikacje i parametry mogą zostać zmienione bez uprzedzenia. HU: A műszaki adatok és részletek előzetes értesítés nélkül megváltozhatnak. RO: Specificațiile și detaliile pot fi modificate fără înștiințare prealabilă. BG: Спецификациите и детайлите подлежат на промяна без предварително уведомление. RU: Технические характеристики и данные могут изменяться без предварительного извещения. ET: Tehnilisi kirjeldusi ja üksikasju võidakse muuta eelneva etteteatamiseta. LV: Specifikācijas un detaļas var tikt mainītas bez iepriekšēja paziņojuma. LT: Konstrukcija ir specifikacijos gali keistis be išankstinio įspėjimo. JA: 仕様および情報は事前通知無しに変更する場合があります。 ZH: 规格和详情如有变更，恕不另行通知。 KO: 사양 및 내용은 예고없이 변경될 수 있습니다. TH: ข้อกำหนดเฉพาะและรายละเอียดสามารถเปลี่ยนแปลงได้โดยไม่ต้องแจ้งให้ทราบล่วงหน้า MS: Spesifikasi dan butiran adalah tertakluk kepada perubahan tanpa notis terlebih dahulu.</p>		



HEAD QUARTER

DENMARK

Nilfisk A/S
Kornmarksvej 1
DK-2605 Broendby
Tel.: (+45) 4323 8100
www.nilfisk.com

SALES COMPANIES

ARGENTINA

Nilfisk srl.
Edificio Central Park
Herrera 1855, 6th floor/604
Ciudad de Buenos Aires
Tel.: (+54) 11 6091 1571
www.nilfisk.com.ar

AUSTRALIA

Nilfisk Pty Ltd
Unit 1/13 Bessemer Street
Blacktown NSW 2148
Tel.: (+61) 2 98348100
www.nilfisk.com.au

AUSTRIA

Nilfisk GmbH
Metzgerstrasse 68
5101 Bergheim bei Salzburg
Tel.: (+43) 662 456 400 90
www.nilfisk.at

BELGIUM

Nilfisk n.v.-s.a.
Riverside Business Park
Boulevard Internationalelaan 55
Bâtiment C3/C4 Gebouw
Bruxelles 1070
Tel.: (+32) 14 67 60 50
www.nilfisk.be

BRAZIL

Nilfisk do Brasil
Av. Eng. Luis Carlos Berrini, 550
40 Andar, Sala 03
SP - 04571-000 Sao Paulo
Tel.: (+11) 3959-0300 / 3945-4744
www.nilfisk.com.br

CANADA

Nilfisk Canada Company
240 Superior Boulevard
Mississauga, Ontario L5T 2L2
Tel.: (+1) 800-668-8400
www.nilfisk.ca

CHILE

Nilfisk S.A. (Comercial KCS Ltda)
Salar de Llamara 822
8320000 Santiago
Tel.: (+56) 2684 5000
www.nilfisk.cl

CHINA

Nilfisk
4189 Yindu Road
Xinzhuan Industrial Park
201108 Shanghai
Tel.: (+86) 21 3323 2000
www.nilfisk.cn

CZECH REPUBLIC

Nilfisk s.r.o.
VGP Park Horní Počernice
Do Čertous 1/2658
193 00 Praha 9
Tel.: (+420) 244 090 912
www.nilfisk.cz

DENMARK

Nilfisk Danmark A/S
Industrivej 1
Hadsund, DK-9560
Tel.: 72 18 21 20
www.nilfisk.dk

FINLAND

Nilfisk Oy Ab
Koskelontie 23 E
02920 Espoo
Tel.: (+358) 207 890 600
www.nilfisk.fi

FRANCE

Nilfisk SAS
26 Avenue de la Baltique
Villebon sur Yvette
91978 Courtabouef Cedex
Tel.: (+33) 169 59 87 00
www.nilfisk.fr

GERMANY

Nilfisk GmbH
Guido-Oberdorfer-Straße 2-10
89287 Bellenberg
Tel.: (+49) (0)7306/72-444
www.nilfisk.de

GREECE

Nilfisk A.E.
Αναπαύσεως 29
Κορωπί T.K. 194 00
Tel.: (30) 210 9119 600
www.nilfisk.gr

HOLLAND

Nilfisk B.V.
Versterkerstraat 5
1322 AN Almere
Tel.: (+31) 036 5460760
www.nilfisk.nl

HONG KONG

Nilfisk Ltd.
2001 HK Worsted Mills
Industrial Building
31-39, Wo Tong Tsui St.
Kwai Chung, N.T.
Tel.: (+852) 2427 5951
www.nilfisk.com

HUNGARY

Nilfisk Kft.
II. Rákóczi Ferenc út 10
2310 Szigetszentmiklós-Lakihegy
Tel.: (+36) 24 475 550
www.nilfisk.hu

INDIA

Nilfisk India Limited
Pramukh Plaza, 'B' Wing, 4th floor, Unit
No. 403
Cardinal Gracious Road, Chakala
Andheri (East) Mumbai 400 099
Tel.: (+91) 22 6118 8188
www.nilfisk.in

IRELAND

Nilfisk
1 Stokes Place
St. Stephen's Green
Dublin 2
Tel.: (+35) 3 12 94 38 38
www.nilfisk.ie

ITALY

Nilfisk SpA
Strada Comunale della Braglia, 18
26862 Guardamiglio (LO)
Tel.: (+39) (0) 377 414021
www.nilfisk.it

JAPAN

Nilfisk Inc.
1-6-6 Kita-shinyokohama, Kouhoku-ku
Yokohama, 223-0059
Tel.: (+81) 45548 2571
www.nilfisk.com

MALAYSIA

Nilfisk Sdn Bhd
Sd 33, Jalan KIP 10
Taman Perindustrian KIP
Sri Damansara
52200 Kuala Lumpur
Tel.: (60) 3603 627 43 120
www.nilfisk.com

MEXICO

Nilfisk de Mexico, S. de R.L. de C.V.
Pirineos #515 Int.
60-70 Microparque
Industrial WSantiago
76120 Queretaro
Tel.: (+52) (442) 427 77 00
www.nilfisk.com

NEW ZEALAND

Nilfisk Limited
Suite F, Building E
42 Tawa Drive
0632 Albany Auckland
Tel.: (+64) 9 414 1996
Website: www.nilfisk.com

NORWAY

Nilfisk AS
Bjørnerudveien 24
1266 Oslo
Tel.: (+47) 22 75 17 80
www.nilfisk.no

PERU

Nilfisk S.A.C.
Calle Boulevard 162, Of. 703, Lima 33-
Perú
Lima
Tel.: (511) 435-6840
www.nilfisk.com

POLAND

Nilfisk Sp. Z.O.O.
Millenium Logistic Park
ul. 3 Maja 8, Bud. B4
05-800 Pruszków
Tel.: (+48) 22 738 3750
www.nilfisk.pl

PORTUGAL

Nilfisk Lda.
Sintra Business Park
Zona Industrial Da Abrunheira
Edificio 1, 1º A
P2710-089 Sintra
Tel.: (+351) 21 911 2670
www.nilfisk.pt

RUSSIA

Nilfisk LLC
Vyatskaya str. 27, bld. 7/1st
127015 Moscow
Tel.: (+7) 495 783 9602
www.nilfisk.ru

SINGAPORE

Den-Sin
22 Tuas Avenue 2
639453 Singapore
Tel.: (+65) 6268 1006
www.densin.com

SLOVAKIA

Nilfisk s.r.o.
Bancíkovej 1/A
SK-821 03 Bratislava
Tel.: (+421) 910 222 928
www.nilfisk.sk

SOUTH AFRICA

WAP South Africa
12 Newton Street
Spartan 1630
Tel.: (+27) 11 975 7060
www.wap.com.za

SOUTH KOREA

Nilfisk Korea
3F Duksoo B/D, 317-15
Sungsoo-Dong 2Ga
Sungdong-Gu, Seoul
Tel.: (+82) 2497 8636
www.nilfisk.co.kr

SPAIN

Nilfisk S.A.
Torre d'Ara,
Passeig del Rengle, 5 Plta. 10ª
08302 Mataró
Tel.: (34) 93 741 2400
www.nilfisk.es

SWEDEN

Nilfisk AB
Taljegårdsgatan 4
431 53 Möndal
Tel.: (+46) 31 706 73 00
www.nilfisk.se

SWITZERLAND

Nilfisk AG
Ringstrasse 19
Kircheberg/Industri Stelz
9500 Wil
Tel.: (+41) 71 92 38 444
www.nilfisk.ch

TAIWAN

Nilfisk Ltd
Taiwan Branch (H.K)
No. 5, Wan Fang Road
Taipei
Tel.: (+88) 6227 00 22 68
www.nilfisk.tw

THAILAND

Nilfisk Co. Ltd.
89 Soi Chokechai-Ruammitr
Viphavadee-Rangsit Road
Ladyao, Jatuchak, Bangkok 10900
Tel.: (+66) 2275 5630
www.nilfisk.co.th

TURKEY

Nilfisk A.S.
Serifali Mh. Bayraktar Bulv. Sehit Sk. No:7
Ümraniye, 34775 Istanbul
Tel.: +90 216 466 94 94
www.nilfisk.com.tr

UNITED ARAB EMIRATES

Nilfisk Middle East Branch
SAIF-Zone
P.O. Box 122298
Sharjah
Tel.: (+971) (0) 655-78813
www.nilfisk.com

UNITED KINGDOM

Nilfisk Ltd.
Nilfisk House, Bowerbank Way
Gilwilly Industrial Estate, Penrith
Cumbria CA11 9BQ
Tel.: (+44) (0) 1768 868995
www.nilfisk.co.uk

UNITED STATES

Nilfisk, Inc.
9435 Winnetka Ave N,
Brooklyn Park
MN- 55445
www.nilfisk.com

VIETNAM

Nilfisk Vietnam
No. 51 Doc Ngu Str.
P. Vinh Phúc, Q.Ba Dinh
Hanoi
Tel.: (+84) 761 5642
www.nilfisk.com