

# BOX TRACK

INSTALLATION  
INSTRUCTIONS



CONGRATULATIONS ON YOUR DECISION TO BRING HOME AN  
AMERICAN MADE PRODUCT OF THE HIGHEST QUALITY.

1-800-891-8312  
support@rustica.com  
www.Rustica.com

DESIGNED AND CRAFTED ENTIRELY IN THE  
**U.S.A.**



DON'T BE A STRANGER.  
FOLLOW US ON SOCIAL MEDIA.



## BOX TRACK Recommended Tools

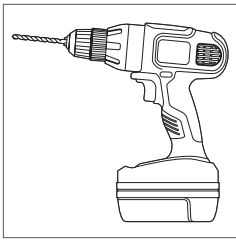

Drill with 1/8", and 1/4", Drill Bits, Phillips Bit and Slotted Bit

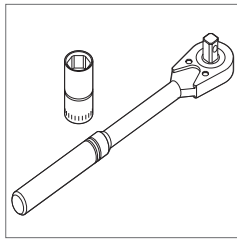

Socket Wrench with 9/16" Socket

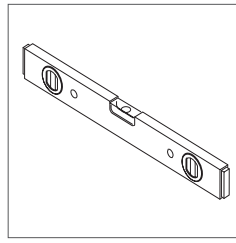

Level

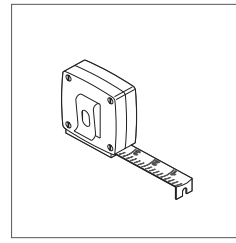

Tape Measure

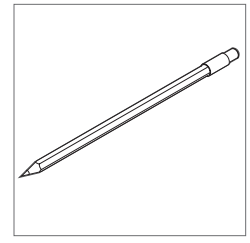

Pencil

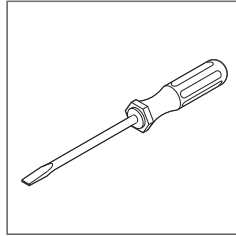

Slotted Screw Driver (Optional)

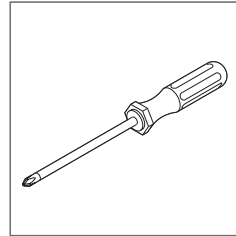

Phillips Screw Driver (Optional)

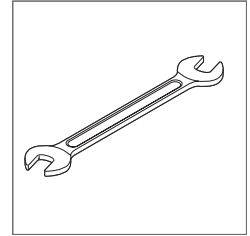

9/16" and 5/8" Wrench

## BOX TRACK Dimensions

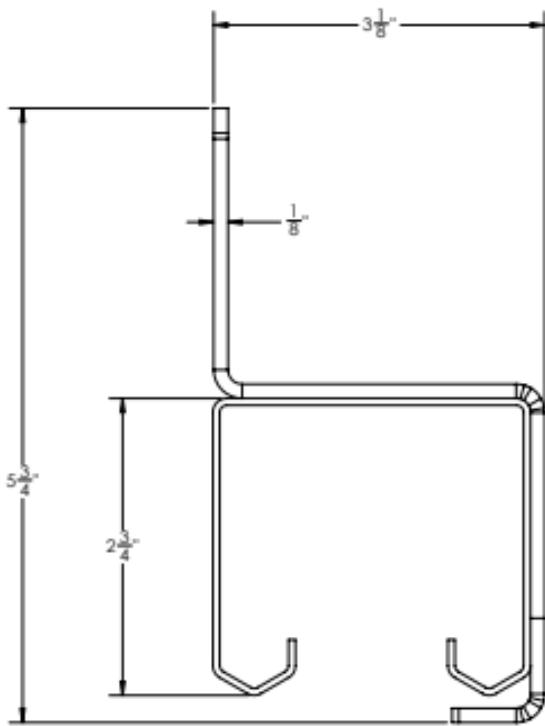

### PARTS

- A. Track
- B. Brackets
- C. End Caps
- D. Hanger Assembly
- E. 1" Washer
- F. Self Tapping Screws
- G. Phillips screws
- H. Lag Screws
- I. Door Guide

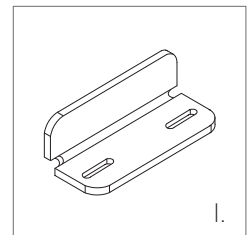
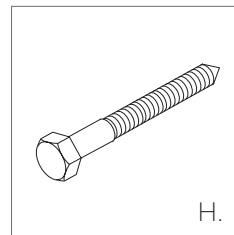
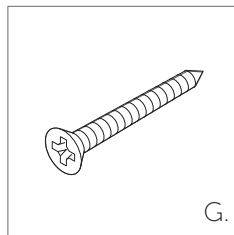
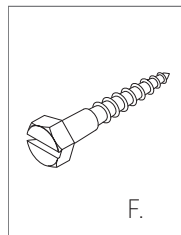
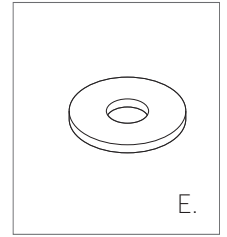
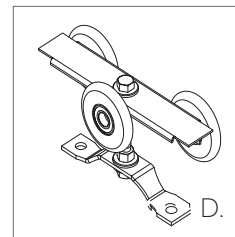
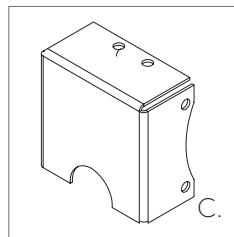
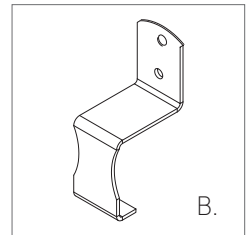
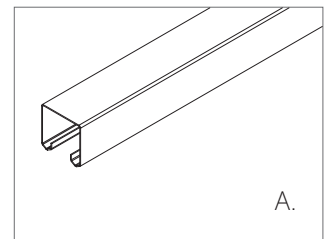

# BOX TRACK Assembly Instructions

## NOTE:

Doors using Floor Mount Door Guides will have a groove on the bottom. Ensure this groove is on the opposite end of the Door Hanger Installation.

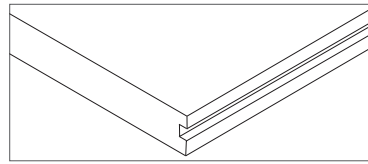

## FIRST THINGS FIRST

Check to see if the floor below the track area is level. If the floor rises more than 1/2" the door may rub or not slide open completely. If the floor is not level, measure from the highest point of the floor surface to the recommended track placement and adjust track placement accordingly.

Ensure the track brackets will be installed onto wall studs. If wall studs are not lining up with the installation a header will be required to provide the necessary strength and stability for the track and door.

Before beginning this installation, ensure that there will be enough room for the door to slide into the track. An area on one side of the track must be wide enough for the width of the door to install properly.

## TRACK & DOOR INSTALLATION

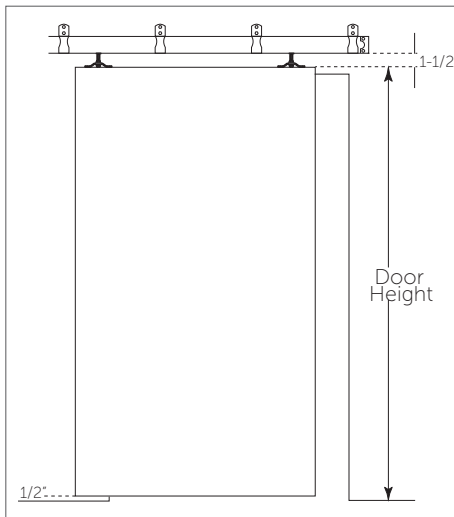

Figure 1

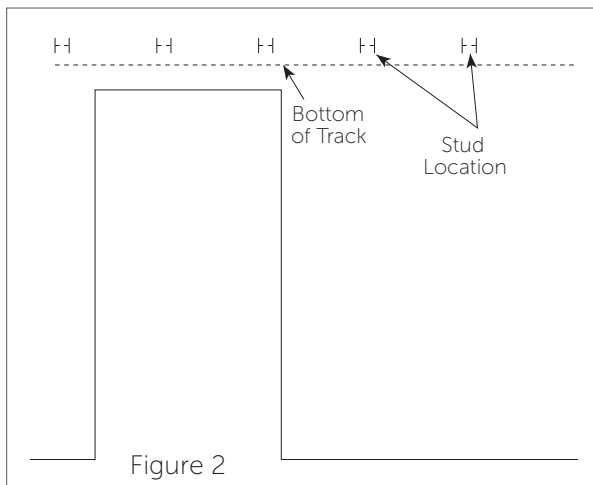

Figure 2

1. To determine where the track should be installed, first measure the height of the door, then add 2" to the door length. 1/2" will be for the clearance between the bottom edge of the door and the floor. 1-1/2" will be from the top of the door to the bottom of the track. (Figure 1).
2. Using a level and a pencil, make a line 2" above the door.
3. Using a stud finder, locate the studs along the area the brackets will be installed (Figure 2).
4. Place the bottom edge of one of the brackets (B.) along the line drawn in step 2 in the stud locations marked in step 3. Using a pencil, mark the center of each bracket hole (Figure 3).
5. Drill out the marked holes using a drill with a 1/4" drill bit (Figure 4).
6. Loosly attach an end bracket (B.) to the wall using two washers (E.) and two lag screws (H.). Do not tighten (Figure 5).

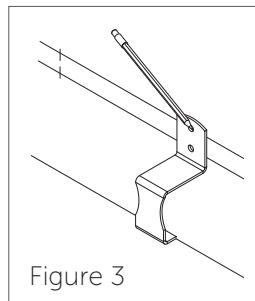

Figure 3

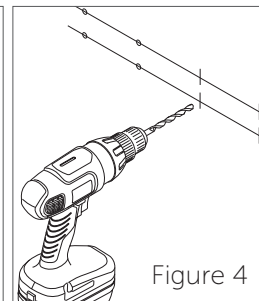

Figure 4

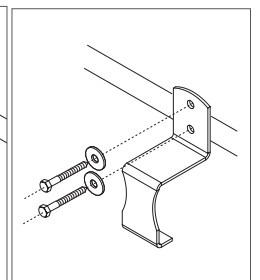

Figure 5



## BOX TRACK Assembly Instructions

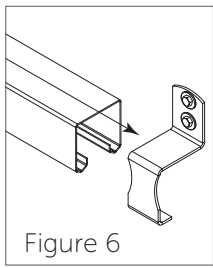

Figure 6

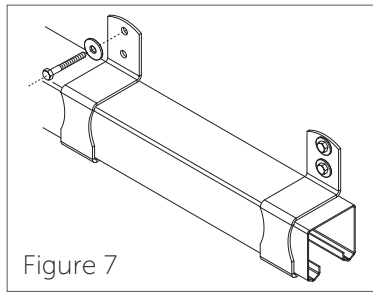

Figure 7

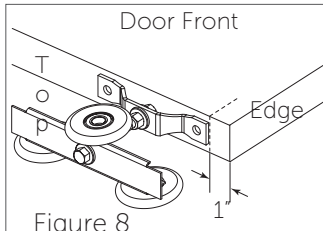

Figure 8

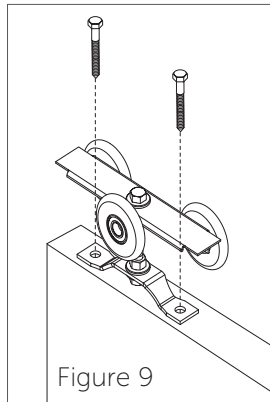

Figure 9

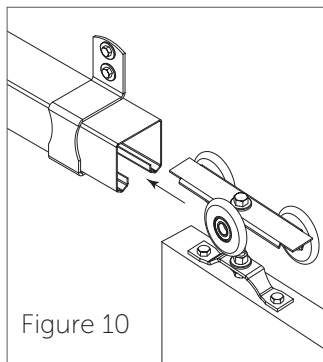

Figure 10

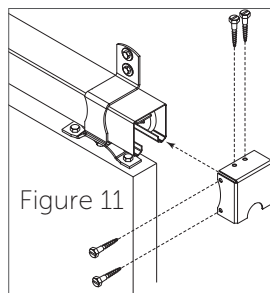

Figure 11

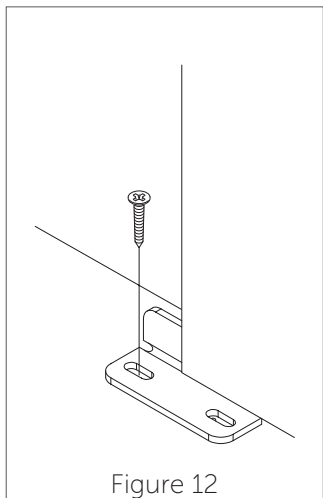

Figure 12

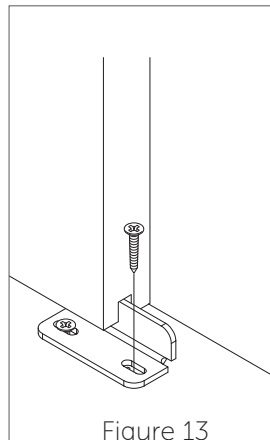

Figure 13

7. Slide the box track (A) through the bottom of the bracket. Tighten the lag screws. Install the other end bracket. Slide the other end of the box track into the end bracket so both brackets are supporting the box track (Figure 6).
8. Install remaining brackets (Figure 7).
9. Lay the door with the front facing up on a flat, level surface. Measure 1" from the edge of the door. Mark with a pencil (Figure 8).
10. Repeat step 9 for the opposite edge of the door.
11. Install the hanger (D) on the top of the door with the edge of the hanger lining up with the pencil mark on the top. Secure with two lag screws (H)(Figure 9).
12. Carefully slide the hangers into the box track, ensuring the front wheel aligns with the front track gutter (Figure 10).
13. Slip the end caps (C) over the ends of the box track. Secure in place using self tapping screws (F) (Figure 11).
14. With the door in the closed position, ensure the door is hanging straight using a bubble level.
15. Position the Door Guide (I) part way into the groove in the bottom of the door. (Figure 12). Install the Door Guide using a 1" Phillips screw (G) and a drill with a Phillips bit.
16. Slide the door toward the open position until the other side of the Door Guide is exposed.
17. Install the second 1" Phillips screw (G) using a drill with a Phillips bit (Figure 13).

