

beurer

TS 15 ECOLOGIC+ Single / Double



EN Heated underblanket
Instruction for Use

ENGLISH



Read these instructions for use carefully. Observe the warnings and safety notes. Keep these instructions for use for future reference. Make the instructions for use accessible to other users. If the device is passed on, provide the instructions for use to the next user as well.





Contents

1. Items included in the package	3	4.4 Switching on.....	7
1.1 Description	3	4.5 Setting the temperature.....	7
2. Important instructions		4.6 Switching off	7
Retain for future use	3	5. Cleaning and care.....	7
3. Intended use.....	5	6. Storage	8
4. Operation.....	6	7. Disposal.....	8
4.1 Safety	6	8. In the event of problems.....	8
4.2 Electrical safety	6	9. Technical data	8
4.3 Putting into operation.....	6	10. Guarantee/service.....	8

Explanation of symbols

The following symbols are used on the device, in these instructions for use, on the packaging and on the type plate for the device:

	WARNING: Warning of risks of injury or health hazards		
	CAUTION: Safety information about possible damage to appliance/accessories		
	NOTE: Important information		
	Read the instructions		Do not insert pins
	Do not use folded or rucked		Not to be used by very young children (0 - 3 years)
	Manufacturer		
	The device has double protective insulation and therefore complies with protection class 2.		
	Please dispose of the device in accordance with EC Directive – WEEE (Waste Electrical and Electronic Equipment).		
	Marking to identify the packaging material. A = Material code, B = Material number: 1-7 = Plastics, 20-22 = Paper and cardboard		

UK CA	United Kingdom Conformity Assessed Mark		
CE	This product satisfies the requirements of the applicable European and national directives.		
	Wash at a maximum temperature of 30 °C, Very gentle wash		Do not iron
			Do not bleach
	Do not dry-clean		Do not dry in a tumble dryer

1. Items included in the package

Check that the exterior of the cardboard delivery packaging is intact and make sure that all contents are present. Before use, ensure that there is no visible damage to the device or accessories and that all packaging material has been removed. If you have any doubts, do not use the device and contact your retailer or the specified Customer Service address.

- 1 Heated underblanket
- 1 Control
- 1 Instructions for use

1.1 Description

1. Power plug
2. Power cord
3. Control
4. Illuminated temperature settings
5. Slider for ON/OFF and temperature settings
6. Plug-in coupling

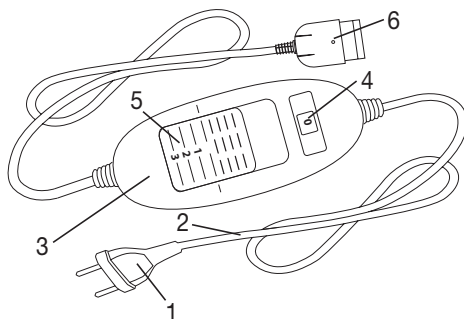

2. Important instructions

Retain for future use

WARNING

- Non-observance of the following notes may result in personal injury or material damage (electric shock, skin burns, fire). The following safety and hazard information is not only intended to protect your health and the health of others, it should also protect the product. For this reason, pay attention to these safety notes and include these instructions when handing over the product to others.
- This heated underblanket must not be used by persons who are not sensitive to heat or by other vulnerable persons who may not be able to react to overheating (e.g. diabetics, people with skin alterations due to illness or scarred tissue in the application area, after taking pain relief medication or alcohol).

- This heated underblanket must not be used by very young children (0-3 years old) as they are unable to respond to overheating.
- This heated underblanket can be used by children older than 3 and younger than 8 years of age provided they are supervised. For this, the control must always be set to the minimum temperature.
- This heated underblanket may be used by children over the age of 8 and by people with reduced physical, sensory or mental skills or a lack of experience or knowledge, provided that they are supervised or have been instructed on how to use the heated underblanket safely, and are fully aware of the consequent risks of use.
- Children must not play with the heated underblanket.
- Cleaning and user maintenance must not be performed by children unless supervised.
- This heated underblanket is not designed for use in hospitals.
- This heated underblanket is only intended for domestic/private use, not for commercial use.
- Do not insert needles.
- Do not use when folded or rucked.
- Do not use if wet.
- Before using it on an adjustable bed, check that the heated underblanket and the cables are not, for example, trapped in a hinge or bunched up.
- This heated underblanket may only be used in conjunction with the control specified on the label.
- This heated underblanket must only be connected to the mains voltage that is specified on the label.
- If the heated underblanket is being used over several hours, we recommend that you set the lowest temperature setting on the control to avoid the body overheating and thereby any potential burns to the skin or heat stroke.
- The electrical and magnetic fields emitted by this heated underblanket may interfere with the function of a pacemaker. However, they are still well below the limits: electrical field strength: max. 5000 V/m, magnetic field strength: max. 80 A/m, magnetic flux density: max. 0.1 millitesla. Please therefore consult your doctor and the manufacturer of your pacemaker before using this heated underblanket.
- Do not pull, twist or make sharp bends in the cables.

- If cable and control are not positioned properly, there may be a risk of becoming entangled in, being strangled by, tripping over, or stepping on the cable and control of the heated underblanket. The user must ensure that excess lengths of cable, and cables in general, are safely routed.
- Please check this heated underblanket frequently for signs of wear and tear or damage. If any such signs are evident, if the heated underblanket has been used incorrectly or if it no longer heats up, it must be checked by the manufacturer before being switched on again.
- Under no circumstances should you open or repair the heated underblanket (including the accessories) yourself because faultless functionality can no longer be guaranteed thereafter. Failure to observe this will invalidate the warranty.
- If the mains connection cable of this heated underblanket is damaged, it must be disposed of. If it cannot be removed, the heated underblanket must be disposed of.
- Do not expose control and cables to direct sunlight.
- When this heated underblanket is switched on:
 - Do not place any sharp objects on it
 - Do not place any heat sources, such as hot water bottles, heat pads or similar, on it
- The electronic components in the control warm up when the heated underblanket is in use. For this reason, the control must never be covered or placed on the heated underblanket when it is in use.
- Allow the heated underblanket to cool down before storing it away. Otherwise the heated underblanket may get damaged.
- To avoid severe creasing in the heated underblanket, do not place any objects on top of it while it is being stored. Otherwise material damage may occur.
- It is essential to observe the information relating to the following chapters: Operation, Cleaning and maintenance, Storage.
- If you should have any questions about using our devices, please contact our Customer Services department.

3. Intended use



CAUTION

- This heated underblanket is designed for warming beds, only.
- Heated underblankets are not suitable to be used with memory foam mattresses.
- Due to the wide variety of mattress types available, heated underblankets may not be suitable for all mattresses. Always check with your mattress manufacturer to confirm suitability before use.

4. Operation

4.1 Safety



CAUTION

- Your heated underblanket has been designed and fully tested to the European Safety Standards. It has been certified by the Intertek Testing and Certification Ltd. UK and shows the safety mark "BEAB Approved".
- This heated underblanket is equipped with a SAFETY SYSTEM. This sensor technology prevents the entire surface of the heated underblanket from overheating by automatically switching off the heated underblanket in the event of a fault. If the safety system has switched off the heated underblanket, the temperature setting is not illuminated any more even when the heated underblanket is switched on.
- Please note that the heated underblanket is not operable due to safety reasons, therefore contact Beurer Customer Service for further advice.
- Do not connect the defective heated underblanket with another control of the same type. This would trigger a permanent switch-off via the control's safety system.

4.2 Electrical safety

Your heated underblanket has a UK plug. If your heated underblanket becomes damaged or worn, you should have the plug top replaced by a qualified electrician who understands how to carry out this repair safely. The plug needs a 3-amp fuse (BS1362 rated).



CAUTION

Make sure that the heated underblanket is spread out entirely flat and that it will not rumple up or crease when in use.

- To operate the heated underblanket connect the control to the heated underblanket by plugging in the connector.
- Then plug in the power plug into the mains outlet.

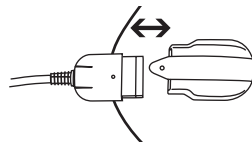

4.3 Putting into operation

Our blankets are designed as underblankets only. They must be fitted to the bed between the mattress and the bed sheet.

1. Leave space for the pillow and put the blanket on the mattress with the connector at the pillow end, so the connector is face down under the blanket.
2. Pass tape 'A' under the mattress, then up through the eyelet 'B', down under the mattress and tie it tightly into the eyelet 'C'.
3. Pass the centre tape 'D' under the mattress and tie it tightly into the eyelet 'E'.
4. Pass tape 'F' under the mattress, then up through the eyelet 'G', down under the mattress and tie it tightly into the eyelet 'H'.

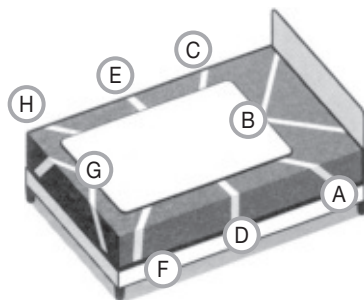

NOTE:

- When you tie the tape through the eyelets, make sure the heated underblanket is not stretched too tightly. The heated blanket should be held in position by the tie tapes. Do not use the heated blanket if it is folded or creased.
- Once you have fitted the heated underblanket on the mattress, put your undersheet on the heated underblanket as usual so that the heated underblanket is between the mattress and sheet.
- Attention: The electronic components in the controller will normally warm up slightly when the heated underblanket is being used. The controller should not lie on or be covered by blankets, pillows etc.

4.4 Switching on

To switch on the heated underblanket, set the slider for ON/OFF and temperature settings to setting 1, 2 or 3. The temperature settings are illuminated when switched on.

4.5 Setting the temperature

Setting 0: OFF

Setting 1: minimum heat

Setting 2: medium heat

Setting 3: maximum heat

NOTE:

- The fastest way to warm up the heated underblanket is to initially set the highest temperature setting.
- We strongly recommend switching on the heated underblanket approx. 30 minutes before going to bed and covering it with the quilt to prevent the warmth from escaping.



WARNING

If the heated underblanket is being used over several hours, we recommend that you set the lowest temperature setting on the control to avoid the body overheating and thereby any potential burns to the skin or heat stroke.

4.6 Switching off

To switch off the heated underblanket, set the slider for ON/OFF and temperature settings to the "0" (OFF) position. The temperature settings are then no longer illuminated.

NOTE:

If the heated underblanket is not used for several days, set the slider for ON/OFF and temperature settings to the "0" (OFF) position and remove the power plug from the socket. Then remove the control from the heated underblanket by disconnecting it at the connector.

When removing the plug from the socket, first lift up the flap as shown in the picture to set the plug free. It is important that you don't use the cable to pull them apart.

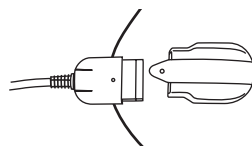

5. Cleaning and care



WARNING

Always remove the power plug from the mains outlet and remove the control from the heated underblanket by disconnecting it at the connector. Otherwise there is a risk of electric shock.



CAUTION

The control must never get in contact to water or other liquids. Otherwise the control may be damaged.

- To clean the control, use a dry, lint-free cloth. Do not use any chemical or abrasive cleaning agents.
- To remove stains from the heated underblanket use a damp cloth and, if necessary, a mild cleaning agent.
- You can dry your underblanket with a tumble dryer on the lowest heat.



CAUTION

Note that the heated underblanket must not be dry-cleaned, wrung out or ironed.

- The heated underblanket is machine washable.
- Set the washing machine to a particularly gentle, 30 °C cycle (woolens programme). Use a mild detergent with dosage according to the manufacturer's instructions.



CAUTION

Note that the heated underblanket will suffer from too frequent washing and drying. For its entire life, therefore, the heated underblanket should be washed and dried not more than 5 times in a washing machine.

- While the heated underblanket is still damp after washing and drying, shape it to its original form and size and place it flat over a clothes drying rack to dry.



CAUTION

- Do not attach the heated underblanket to washing lines with washing pegs or the like. Otherwise the heated underblanket may be damaged.
- Only reconnect the control to the heated underblanket after the connector and the heated underblanket are completely dry. Otherwise the heated underblanket may be damaged.



WARNING

Under no circumstances switch on the heated underblanket to dry it. Otherwise there is a risk of an electric shock.

6. Storage

When not in use we recommend to store the heated underblanket in its original packaging. For this purpose, disconnect the control from the heated underblanket by unplugging the plug-in coupling.

7. Disposal

For environmental reasons, do not dispose of the device in the household waste at the end of its useful life. Dispose of the unit at a suitable local collection or recycling point. Dispose of the device in accordance with EC Directive – WEEE (Waste Electrical and Electronic Equipment). If you have any questions, please contact the local authorities responsible for waste disposal.



8. In the event of problems

Problem	Cause	Solution
The temperature settings are not illuminated while - the control is properly connected to the heating underblanket - the power plug is connected to a working socket - the slider is set to 1, 2 or 3	The safety system has switched the heating underblanket off permanently.	Contact Beurer Customer Service for further advice.

9. Technical data

	Type	Supply Voltage	Input
TS 15 Single	STW-Q	220–240V / 50–60 Hz	55-65 W
TS 15 Double	KSW-Q	220–240V / 50–60 Hz	85-100 W

10. Guarantee/service

Beurer GmbH, Söflinger Straße 218, 89077 Ulm, Germany (hereinafter referred to as “Beurer”) provides a guarantee for this product, subject to the requirements below and to the extent described as follows.

Claiming the guarantee shall not affect the Purchaser’s statutory guarantee rights arising from the purchase agreement with the Seller in the event of defects. The Purchaser may exercise these statutory guarantee rights free of charge. The guarantee shall apply without prejudice to any mandatory statutory provisions on liability.

Beurer guarantees the perfect functionality and completeness of this product.

The worldwide guarantee period is 3 years, commencing from the purchase of the new, unused product from the seller.

The guarantee only applies to products purchased by the buyer as a consumer and used exclusively for personal purposes in the context of domestic use.

German law shall apply.

During the guarantee period, should this product prove to be incomplete or defective in functionality in accordance with the following provisions, Beurer shall carry out a repair or a replacement delivery free of charge, in accordance with these guarantee conditions.

If the buyer wishes to make a guarantee claim, they should approach their retailer at first instance. For further assistance, they can revert to the service addresses below.

The buyer will then receive further information about the processing of the guarantee claim, e.g. where they can send the product and what documentation is required.

A guarantee claim shall only be considered if the buyer can provide Beurer, or an authorised Beurer partner, with

- a copy of the invoice/purchase receipt, and
- the original product.

The following are explicitly excluded from this guarantee:

- deterioration due to normal use or consumption of the product;
- accessories supplied with this product which are worn out or used up through proper use (e.g. batteries, rechargeable batteries, cuffs, seals, electrodes, light sources, attachments and nebuliser accessories);
- products that are used, cleaned, stored or maintained improperly and/or contrary to the provisions of the instructions for use, as well as products that have been opened, repaired or modified by the buyer or by a service centre not authorised by Beurer;
- damage that arises during transport between manufacturer and customer, or between service centre and customer;
- products purchased as seconds or as used goods;
- consequential damage arising from a fault in this product (however, in this case, claims may exist arising from product liability or other compulsory statutory liability provisions).

Repairs or an exchange in full do not extend the guarantee period under any circumstances.

11. Helpline

Distributors:

EN Beurer UK Ltd, Suite 16, Stonecross Place, Stonecross Lane North,
WA3 2SH Lownton, Phone 0844 488 9100, Fax 0844 488 9101

IE Charlie Shields Ltd., 3 & 4 Goldenbridge Industrial Est.,
Dublin 8, Phone + 353 1 454 5844

Manufacturer:

Beurer GmbH
Soeflinger Strasse 218
89077 Ulm/Germany



Website: www.beurer.com

We have a policy of continuously improving product design and quality.
We have the right to improve our heated underblanket models at any time.

UK UK-Importer: Beurer UK Ltd. • Suite 16 • Stonecross Place
CA Stonecross Lane North • WA3 2SH Lowton • United Kingdom

 BEURER GmbH • Söflinger Str. 218 • 89077 Ulm (Germany)
www.beurer.com • www.beurer-healthguide.com

