

beurer

HT 65



EN Wave styler
Instructions for use

CE

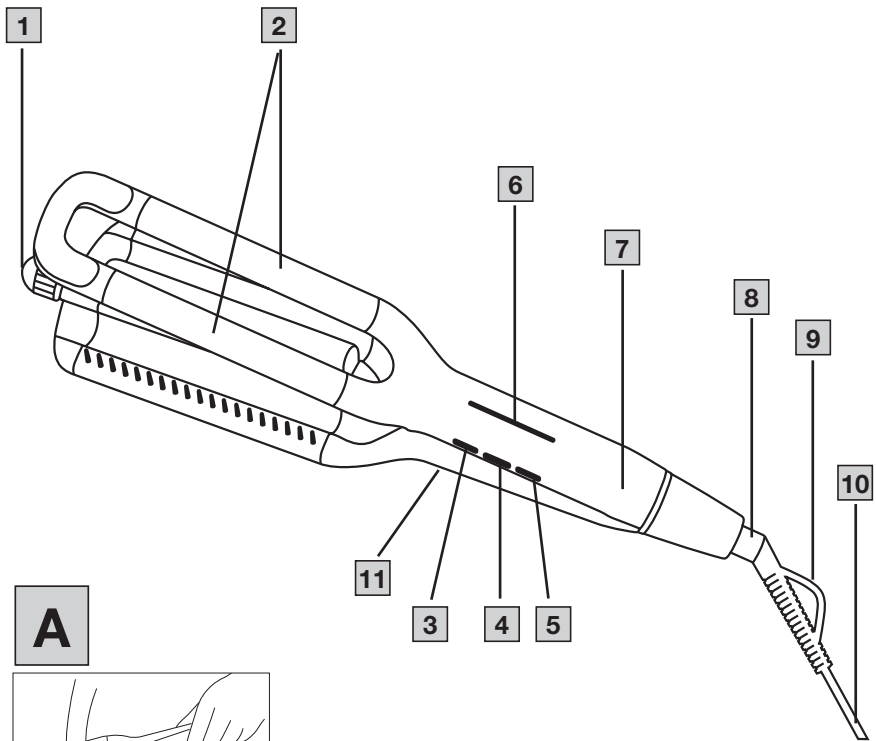

A

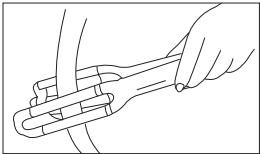

B

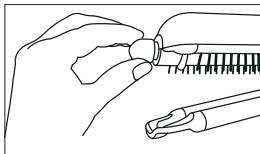

C

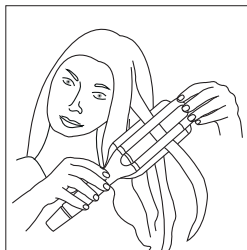

D



ENGLISH



Read these instructions for use carefully. Observe the warnings and safety notes. Keep these instructions for use for future reference. Make the instructions for use accessible to other users. If the device is passed on, provide the instructions for use to the next user as well.

▲ WARNING

- The device is only intended for domestic/private use, not for commercial use.
- This device may be used by children over the age of 8 and by people with reduced physical, sensory or mental skills or a lack of experience or knowledge, provided that they are supervised or have been instructed on how to use the device safely, and are fully aware of the consequent risks of use.
- Children must not play with the device.
- Cleaning and user maintenance must not be performed by children unless supervised.
- If the mains connection cable of this device is damaged, it must be replaced by the manufacturer, its customer service department or a similarly qualified person to avoid any risk.
- When using the device in the bathroom, unplug the mains plug after use, as water in the vicinity constitutes a danger, even when the device is switched off.
- Never use the device near baths, wash basins, showers or other objects containing water or other liquids – risk of electric shock!

- As an additional safety measure, we recommend the installation of a residual-current circuit device (RCD). The rated operational current should not exceed 30 mA in the bathroom circuit. Your local electrical specialist can provide you with the relevant information.

Table of contents

1. Signs and symbols	5	5. Cleaning and maintenance	7
2. Intended use.....	5	6. Disposal.....	7
3. Device description.....	5	7. Technical data	7
4. Usage	6	8. Warranty	7
4.1 Starting the application.....	6		
4.2 After use.....	6		

Included in delivery

Check that the exterior of the cardboard delivery packaging is intact and make sure that all contents are present. Before use, ensure that there is no visible damage to the device or accessories and that all packaging material has been removed. If you have any doubts, do not use the device and contact your retailer or the specified Customer Service address.

1 x Wave styler

1 x Set of these instructions for use

1. SIGNS AND SYMBOLS

The following symbols are used on the device, in these instructions for use, on the packaging and on the type plate for the device:

WARNING

Indicates a potentially impending danger. If it is not avoided, there is a risk of death or serious injury.

CAUTION

Indicates a potentially impending danger. If it is not avoided, slight or minor injuries may result.

NOTICE

Indicates a potentially harmful situation. If it is not avoided, the system or something in its vicinity may be damaged.



Product information

Note on important information



Protection class II device



Marking to identify the packaging material. A = Material code, B = Material number: 1-7 = Plastics, 20-22 = Paper and cardboard



Separate the product and packaging elements and dispose of them in accordance with local regulations.



The electronic device must not be disposed of with household waste



Read the instructions



CE labelling

This product satisfies the requirements of the applicable European and national directives.



United Kingdom Conformity Assessed Mark



Manufacturer



Danger

The device must not be used near to water or in water (e.g. in a wash basin, or in the shower or bath) – risk of electric shock!



Importer

2. INTENDED USE

The wave styler must only be used by individuals for shaping and styling and is for personal use only! Do not use the wave styler on synthetic hair or on animals.

WARNING

The device is suitable only:

- for external use.
- for the intended purpose and as specified in these instructions for use.

Any improper use may be dangerous!

3. DEVICE DESCRIPTION

The associated drawings are shown on page 2.

1

Dial for setting the wave size

2

Heating rods

3

+ Button for increasing the temperature

4

- Button for reducing the temperature

5

ON/OFF button 

6

LED temperature display (°C)

7

Handle

8

360° swivel joint

9

Hanging loop

10



Mains cable

11

Transport lock

4. USAGE

4.1 Starting the application

1. Dry your hair thoroughly before using the wave styler.
2. Make sure that your hair is clean and free from styling products. This excludes special products designed to help your hair when shaping curls or waves.
3. Comb your hair to get rid of any tangles.
4. Switch on the wave styler by pressing the ON/OFF button **1** **5**.
5. To make it easier to set the temperature, first close the wave styler and slide the transport lock **11** to the  position. Set your desired temperature setting using the - button **4** or + button **3**. The device is pre-set to 180 °C when it is switched on. Once you have set the temperature, slide the transport lock **11** to the  position. The respective temperature setting starts to flash white in the LED temperature display **6**. Once the temperature setting lights up white permanently, the heating rods **2** have reached the configured temperature setting and the wave styler is ready for use. The button lock can be activated by pressing the minus button **4** for 3 seconds. A red LED appears in the LED temperature display **6**. To cancel the button lock, press the minus button **6** again for 3 seconds. The red LED goes out in the LED temperature display **6**. The button lock is now deactivated again.
6. Separate your hair into individual sections with a width of approx. 2-4 cm. Hold the strands taut.
7. Place the section of hair between the heating rods **2** starting at the roots. Make sure that you do not touch your scalp with the heating rods **2**. **A**

NOTE

First press the dial **1** down and then turn it to the left or right to set your desired wave size. **B**
The following styles can be set:

Beach Waves

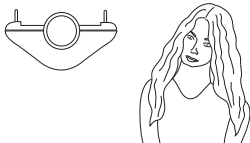

Natural waves

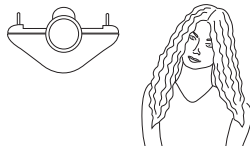

Mermaid Waves

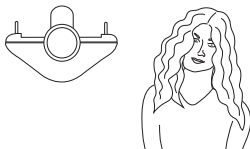

Water waves

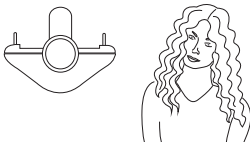

8. Press the handle **7** of the wave styler shut so that the hair section is enclosed by the heating rods. Exert a small amount of pressure and hold this position for a few seconds. **C**
9. Release the handle **7** of the wave styler. Place the wave styler a little lower on the hair section so that the part that has already been styled is not done again. Repeat the application along the entire length of the hair section. **D**

NOTE

The wave styler features a safety switch-off function. If you want to use the wave styler for longer than 30 minutes, switch the device off and then immediately on again. The safety switch-off function is then reset to activate again in 30 minutes.

4.2 After use

1. To switch off the wave styler after use, hold down the ON/OFF button **1** **5** for three seconds. The heating rods **2** are now switched off and the LED temperature display **6** goes out.
2. Pull the mains plug out of the socket after each use. Do not wind the mains cable **10** around the device!
3. Place the wave styler on a stable, horizontal and non-flammable surface to cool down. Make sure that the

hot heating rods **2** do not touch the surface! Risk of fire!

4. Wait until the heating rods **2** of the wave styler have cooled down completely. Then store the wave styler in a dry place out of the reach of children. Alternatively, you can hang up the wave styler on a hook using the hanging eyelet **9**.

5. CLEANING AND MAINTENANCE

▲ IMPORTANT

- Always pull the mains plug out of the socket before cleaning the device. Risk of electric shock!
- Do not clean the wave styler with highly flammable liquids. Risk of fire!

▲ WARNING

- Ensure that no water gets inside the device! Risk of electric shock!

6. DISPOSAL

For environmental reasons, do not dispose of the device in household waste at the end of its service life. Dispose of the device at a suitable local collection or recycling point in your country. Observe the local regulations for material disposal. Dispose of the device in accordance with EC Directive – WEEE (Waste Electrical and Electronic Equipment).

If you have any questions, please contact the local authorities responsible for waste disposal.



You can obtain the location of collection points for old devices from the local or municipal authorities, local waste disposal company or your dealer, for example.

7. TECHNICAL DATA

Weight:	Approx. 660 g
Voltage supply	220-240 V~, 50-60 Hz
Power consumption	120 W
Protection class	II
Ambient conditions	Only approved for indoors
Permissible temperature range	-10 to +40°C

Subject to technical changes.

8. WARRANTY

Further information on the warranty and warranty conditions can be found in the warranty leaflet supplied.



UK: Beurer UK Ltd., Suite 16, Stonecross Place, Stonecross Lane North, WA3 2SH Lowton, United Kingdom



Beurer GmbH, Söflinger Str. 218, 89077 Ulm, Germany, www.beurer.com

