

beurer

BY 52



EN Baby food and bottle warmer
Instruction for use

CE



Read these instructions for use carefully and keep them for later use, be sure to make them accessible to other users and observe the information they contain.

WARNING

1. Do not use the device if it shows signs of damage or does not function properly. In these cases, contact Customer Services.
 2. This device may be used by children over the age of 8 and by people with reduced physical, sensory or mental skills or a lack of experience or knowledge, provided that they are supervised or have been instructed on how to use the device safely, and are fully aware of the consequent risks of use.
 3. Children must not play with the device.
 4. Keep the device and the connection cable away from children under the age of 3 years.
 5. Cleaning and user maintenance must not be performed by children unless supervised.
 6. Check that the device and the mains cable are in perfect working order before each usage. In the event of damage, the device must not be used.
 7. Any improper use can be dangerous.
 8. Keep packaging material away from children (danger of suffocation).
 9. If the mains connection cable of this device is damaged, it must be disposed of. If it cannot be removed, the device must be disposed of.
- Always ensure that the device is securely positioned on a level surface.
Risk of scalding through escaping liquids.
 - Warning – the escaping steam is very hot!

Contents

1. Included in delivery:	3	7. Usage	4
2. Signs and symbols	3	8. Cleaning and maintenance.....	5
3. Warnings and safety notes.....	3	9. What if there are problems?	6
4. Intended use.....	4	10. Disposal.....	6
5. Device description.....	4	11. Technical specifications	6
6. Initial use	4	12. Warranty/Service	6













1. INCLUDED IN DELIVERY:

Check that the device packaging has not been tampered with and make sure that all contents are present. Before use, ensure that there is no visible damage to the device or accessories and that all packaging material has been removed. If you have any doubts, do not use the device and contact your retailer or the specified Customer Services address.

- Baby food warmer
- Lifter with lid
- These Instructions for Use

2. SIGNS AND SYMBOLS

The following symbols are used on the device, in these instructions for use, on the packaging and on the type plate for the device:

	WARNING Warning instruction indicating a risk of injury or damage to health
	IMPORTANT Safety note indicating possible damage to the device/accessory
	Product information Note on important information
	Read the instructions
	Disposal in accordance with the Waste Electrical and Electronic Equipment EC Directive – WEEE
	Manufacturer
	CE labelling This product satisfies the requirements of the applicable European and national directives.
	Separate the packaging elements and dispose of them in accordance with local regulations.
	Marking to identify the packaging material. A = Material code, B = Material number: 1-7 = Plastics, 20-22 = Paper and cardboard
	United Kingdom Conformity Assessed Mark
	Separate the product and packaging elements and dispose of them in accordance with local regulations.
	The products demonstrably meet the requirements of the Technical Regulations of the EAEU.
	Importer

3. WARNINGS AND SAFETY NOTES

Safety notices

WARNING

- During the warming process, the water becomes hot (risk of scalding).
- Check the temperature of the food before the feed (risk of burning).
- Keep small parts out of reach of children.

- Make sure that cables are not accessible to children.
- The device must only be used on a mains socket with a residual-current protective device (risk of electric shock).
- Unplug the mains cable after each usage and before any cleaning (risk of electric shock).
- Pull out the mains plug in the case of operational faults, before cleaning and when the device is not in use.



IMPORTANT: To avoid damage to the device, please observe the following:

- Fill the device with water before switching it on.
- Do not operate the device outside.
- The device must only be used on an AC network and with the voltage specified on the type plate.
- Unwind the mains cable fully in order to avoid overheating.
- Keep the mains cable away from hot surfaces.
- Do not place the device on water-sensitive surfaces.
- Do not remove the mains plug from the socket by pulling on the cable!
- Do not pull, twist or bend the mains cable.
- Never submerge the device in water. Never rinse it in running water.
- Do not use any additional parts that are not recommended by the manufacturer or offered as accessories.



General advice



- Repairs must only be carried out by Customer Services or authorised suppliers. Do not open or repair the device yourself under any circumstances, otherwise its perfect functioning is no longer guaranteed. Failure to observe this will invalidate the warranty.
- If you should have any questions about using our devices, please contact either your retailer or Customer Services.

4. INTENDED USE

The device is intended for use in the domestic/private environment only, not in commercial situations. Only use the device to warm up baby food/drinks and keep them warm. This device may only be used for the purpose for which it is designed and in the manner specified in the instructions for use. Improper use can be dangerous. The manufacturer is not liable for damage resulting from improper or careless use.

5. DEVICE DESCRIPTION

Overview

- 1 Lifter
- 2 Lid
- 3 Mains cable
- 4 MIN/MAX display
- 5 Control panel
- 6 Power LED
- 7 Heat LED
- 8 Time/Temperature display
- 9 Button for setting time and/or temperature 
- 10 On/Off button 
- 11 Rapid heat-up button 

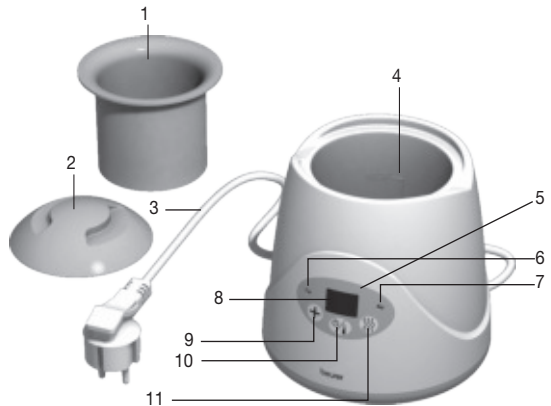

6. INITIAL USE



1. Before use, ensure that the device and accessories (including mains cable) do not have any visible damage.
2. Place the device on a firm, even surface.
3. Connect the mains plug to the socket. The power LED lights up. The device is ready for use.

7. USAGE

Warming up baby food/drinks and keeping them warm:

1. Place the lifter in the baby food warmer and place the bottle or jar in the lifter.
2. Fill the container with sufficient water depending on the size of the jar. Ensure that the water does not overflow.

Starting the warming process:

1. Press button  followed by the rapid heat-up button .
The warming time that is currently set now flashes on the display. On first use, the default setting of 15 minutes is displayed. If the device remains plugged in after the first use, it shows the last entered warming time when subsequently used.
2. Enter the warming time (3 - 18 minutes). To do so, press the  button repeatedly until you have reached the desired warming time. The time is entered in minute increments; after "18", the display begins again at "3".





The warming time is dependent on the initial temperature, the type and quantity of food/drink, the container material (glass/plastic) and the temperature of the water used to fill the device. The following table offers a guide to selecting the warming time for food/drinks to be warmed to 37°C.

	Duration
100 ml milk/chilled	~ 8 min.
250 ml milk/chilled	~ 14 min.
190 g puréed food/room temperature	~ 8 min.

3. Press the rapid heat-up button  again to start the warming process.
The display now continuously shows the remaining warming time. The display starts to flash one minute before the end of the warming process. The warming process stops once the pre-specified warming time has elapsed. The heat LED and the display go out.

Starting the warming process without prior warming:

1. Press the  button to switch the device on. The current temperature is shown on the display. The default setting is 37 °C.
2. To enter the temperature, press the  button repeatedly until you have reached the desired temperature for keeping the food/drink warm (between 35 °C and 85 °C). The temperature increases in the steps 37, 38, 40, 45, 50, 60, 70, 80 until the display reaches "85" and then begins again at 35 °C.
3. Now press the  button again to start the keeping warm process.

Ending the warming/keeping warm process:

1. Press the  button for 2 seconds.
The display and the heater are switched off.
2. Remove the bottle/jar using the lifter.
3. Unplug the mains cable after each usage, pour all the water out and dry the device with a cloth.



4. Shake the bottle or stir the food in the jar.
5. Check that it is the correct temperature.
6. To prevent the breeding of bacteria, which multiply fastest in the temperature range from around 32°C to 42°C, please use the heated baby food as soon as possible.
7. We do not recommend keeping the food warm for any longer, as this can cause important vitamins to be lost.
8. For hygienic and microbiological reasons, do not reheat food that has already been heated.
9. Take care not to overheat food/liquids.

8. CLEANING AND MAINTENANCE

The service life of the device depends on its careful handling:

1. To extend the service life of the device, we recommend that it is not (continuously) operated in the high temperature range.
2. Use boiled or filtered water for warming baby food. This will reduce the build-up of lime scale.
3. Unplug the device before cleaning.
4. To clean the device, use only a damp cloth. Do not use any scouring agents or other cleaning products.
5. Descale the device using vinegar or citric acid. Place the lifter in the device, mix 50 ml of household vinegar with 100 ml of cold water or a packet of citric acid with 200 ml of cold water and pour this solution into the device. Leave the solution to work until the lime scale has been removed; do not operate the device during this time. Pour the liquid away, rinse the device out thoroughly and finally dry it with a cloth.
6. Descale the device approx. every four weeks.

9. WHAT IF THERE ARE PROBLEMS?

Fault	Cause	Action
Water leaks from the bottom of the device when in use.	Device faulty	Switch off the device immediately, unplug it, let the water drain out and return the device to the retailer.
The warming process does not start or does not end.	Thermostat broken	Switch off the device immediately, unplug it, let the water drain out and return the device to the retailer.
No LED display	Mains plug not (correctly) plugged in or device faulty	Check that the mains plug is (correctly) plugged in. If there is still no display, switch off the device, unplug it and return it to the retailer.
The baby food warmer does not switch on once it is plugged in.	No electricity	Check that the mains plug is correctly plugged in.
The temperature on the display does not increase once the warming process is started; the device switches itself off after a while.	No water in the device	Unplug the device, let it cool down, then fill it with water and start the warming process as described in these instructions.
The food is not warm at the end of the warming process.	Not enough water in the device	Unplug the device, let it cool down, then fill it with sufficient water and start the warming process as described in these instructions.

10. DISPOSAL

For environmental reasons, do not dispose of the device in the household waste at the end of its useful life. Dispose of the unit at a suitable local collection or recycling point. Dispose of the device in accordance with EC Directive – WEEE (Waste Electrical and Electronic Equipment). If you have any questions, please contact the local authorities responsible for waste disposal.



11. TECHNICAL SPECIFICATIONS

Operating voltage:	220-240 V ~ / 50/60 Hz
Power consumption:	80 watts
Heating time:	3 - 18 min.
Temperature for keeping warm:	35 °C - 85 °C

12. WARRANTY/SERVICE

Further information on the warranty and warranty conditions can be found in the warranty leaflet supplied.

