

# KOMATSU

## PC2000-11R



Photos may show equipments not available in your area

### Hydraulic excavator

**Engine power**

794 kW / 1060 HP @ 1800 rpm

**Operating weight**

Backhoe: 201400 - 205700 kg

Loading shovel: 196400 kg

**Bucket capacity**

Backhoe: 12.0 - 14.0 m<sup>3</sup>

Loading shovel: 11.0 m<sup>3</sup>

# Walk-around



**Engine power**

**794 kW / 1060 HP @ 1800 rpm**

**Operating weight**

**Backhoe: 201400 - 205700 kg  
Loading shovel: 196400 kg**

**Bucket capacity**

**Backhoe: 12.0 - 14.0 m<sup>3</sup>  
Loading shovel: 11.0 m<sup>3</sup>**

# Excellent economy and high productivity

## Reliability

- Highly durable structure parts and strengthened work equipment
- Long life track parts and extended life of carrier rollers
- Further reliable double sealing structure for hydraulic cylinder
- New "Kprime" tooth system with intuitive lock and increased safety, reliability and productivity

## Productivity, economy & ecology

- New Power plus mode, productivity increased up to 12%
- Optimized P mode, fuel efficiency increased up to 7%
- Enhanced efficiency due to powerful and smooth work equipment operation
- Auto deceleration, auto idling system and auto idle stop function
- ECO guidance, ECO gauge, and fuel consumption gauge

## Safety features

- New developed "full 45° access", hydraulically operated stairway and stairway behind cab
- Operator's cab OPG level 2 (ISO 10262)
- Lock lever auto lock function
- Emergency engine stop switch and fuel cut-off lever

## Comfort features

- Comfortable air-suspension seat with console mounted arm rests
- Low vibration and low noise cab with two large capacity automatic air conditioning units

## Maintenance features

- Spacious walkways around main components for safe inspection and easy maintenance
- Maintenance information are displayed on the monitor screen

## Information & Communication Technology (ICT)

- High resolution, easy-to-use color monitor provides powerful support for energy saving operation
- Operator identity function provides improved machine management and production records
- KomVision, around view monitoring system with new large monitor (10 inch)

## Komtrax Plus

- Komtrax Plus allows immediate diagnostics of machine
- Wireless LAN system



# Productivity features

## Komatsu technology

With the accumulation of a near century history of research, production, field experience and customer feedbacks, Komatsu is able to develop high quality components such as engine, hydraulic and electrical components designed to work efficiently with one another through the intelligent total control system. This "Komatsu technology" brings new generation excavators to the next stage with its improved productivity and economy.

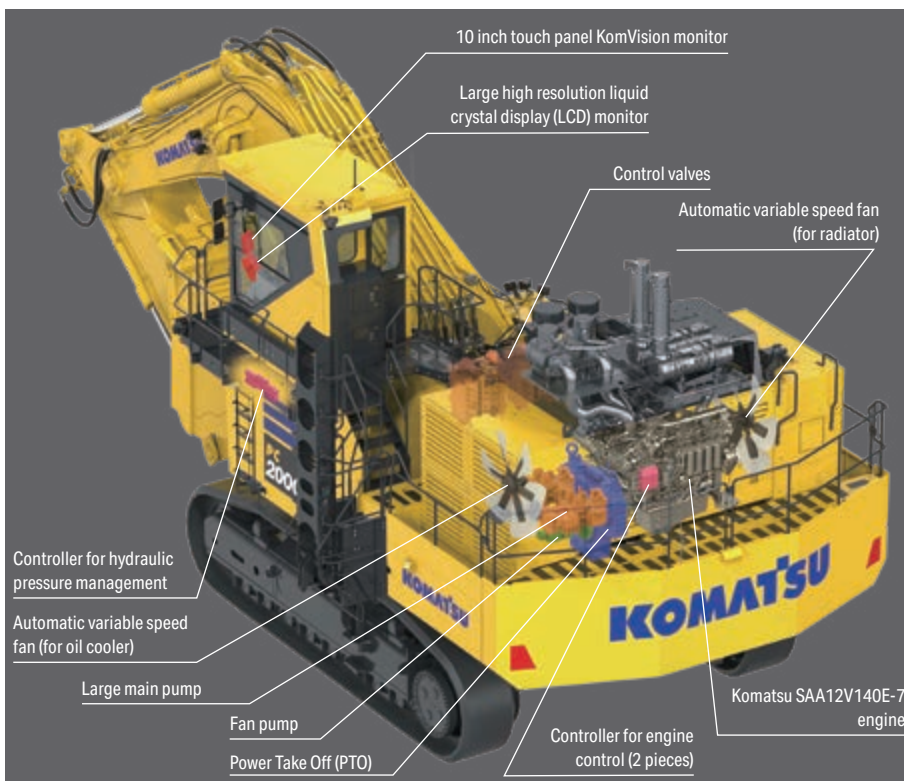

## Powerful and fuel efficient machine due to total power management

PC2000-11R is equipped with the new Komatsu SAA12V140E-7 engine that features clean, fuel efficient and powerful performance. Reduction of power losses in hydraulic system, total power management using on-demand power control system succeeds in drastically increasing the fuel efficiency. The machine has enhanced the function to achieve both productivity and energy-saving operation. PC2000-11R is a new generation powerful clean and economical machine.

## Selectable working modes

Three established work modes are further improved. You can select Power Plus, Power or Economy modes using a one-touch operation on the monitor panel depending on workloads.

Two E mode settings are available enabling the operator to select optimum mode that delivers the best combination of production and fuel efficiency considering working conditions.

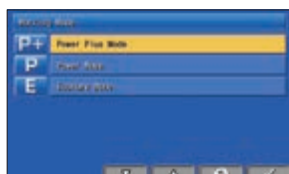

## High productivity with Power plus mode

The PC2000-11R excavator is newly equipped with Power plus (P+) mode in addition to Power (P) and Economy (E) mode.

P+ mode greatly increases the productivity.

### P+ mode productivity

increased by **12%**

vs PC2000-8 P mode (90° swing and loading onto truck)

### P mode fuel efficiency

increased by **7%**

vs PC2000-8 P mode (90° swing and loading onto truck)

### E0 mode fuel consumption

reduced by up to **9%**

vs PC2000-8 P mode (90° swing and loading onto truck)  
Fuel consumption data obtained with prototype machine test.

### Optimized electrical valve control

#### Improved work equipment speed

Digging speed is improved by reduction of hydraulic loss when arm digging.

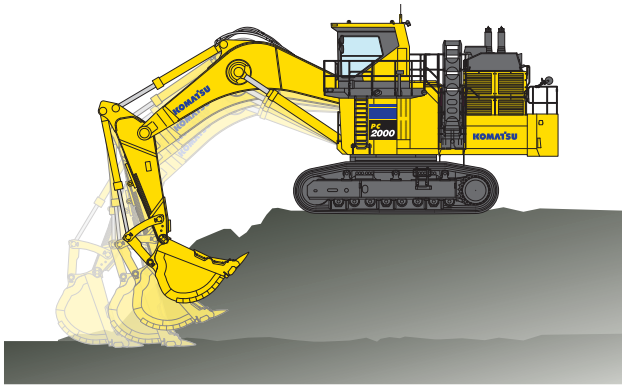

### Shockless boom control

The PC2000-11R boom circuit features a shockless valve to automatically reduce the amount of shaking present when operating the boom. Operator fatigue is reduced (which can improve safety and productivity), and spillage caused by shaking is minimized.

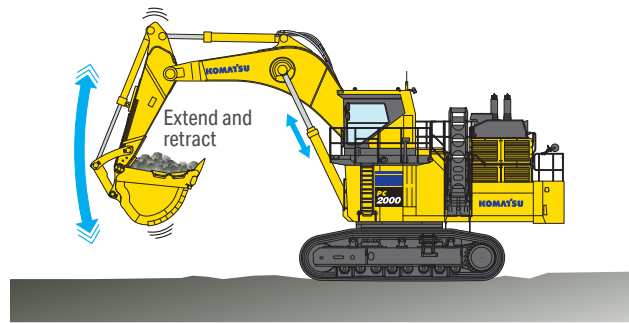

### Improved operability

Optimized spool control by electronic pilot control provides smoother compound movement.

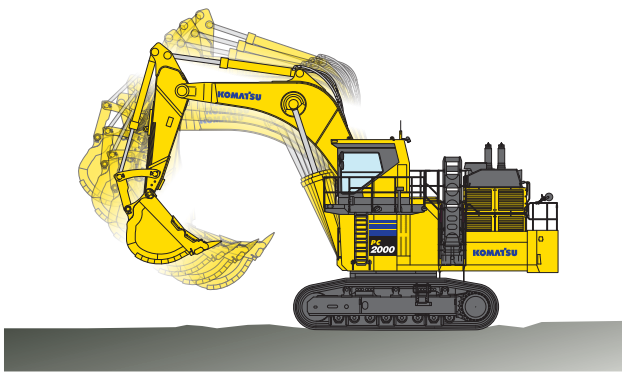

### Two-mode setting for boom

Smooth mode provides easy operation for gathering blasted rock and scraping operations. When maximum digging force is needed, switch to Power mode for more effective excavating.

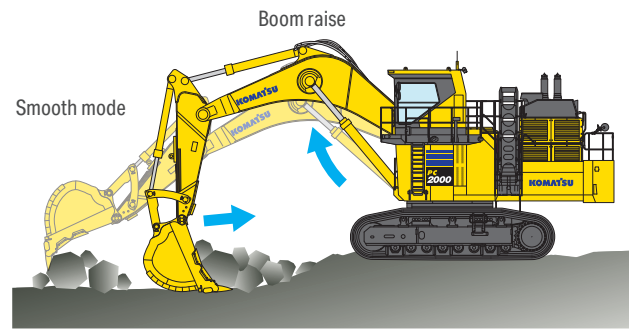

### Heavy lift mode

Turning the heavy lift mode switch "ON" activates the all-out power delivery system to increase the lifting force of the boom (approx. 10%). This is beneficial when handling rock and during heavy lifting applications.

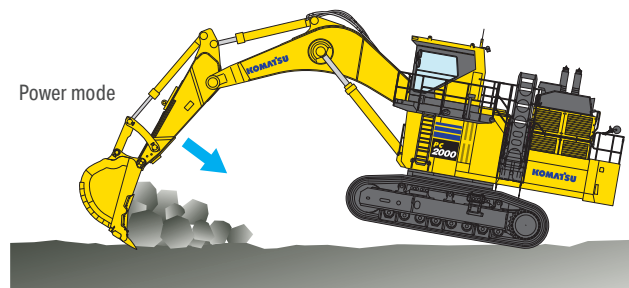
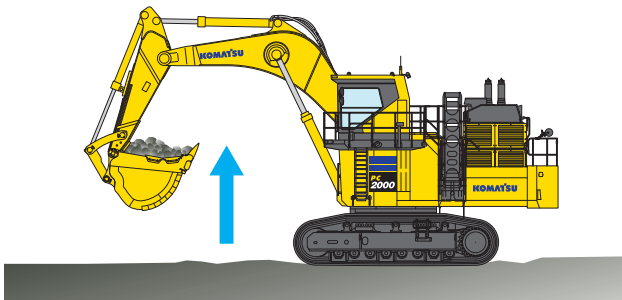

# Ecology & economy features

Komatsu new engine technologies

## Komatsu's new emission regulation-compliant engine

Komatsu provides a powerful engine with latest electronic control technologies and fuel saving features.

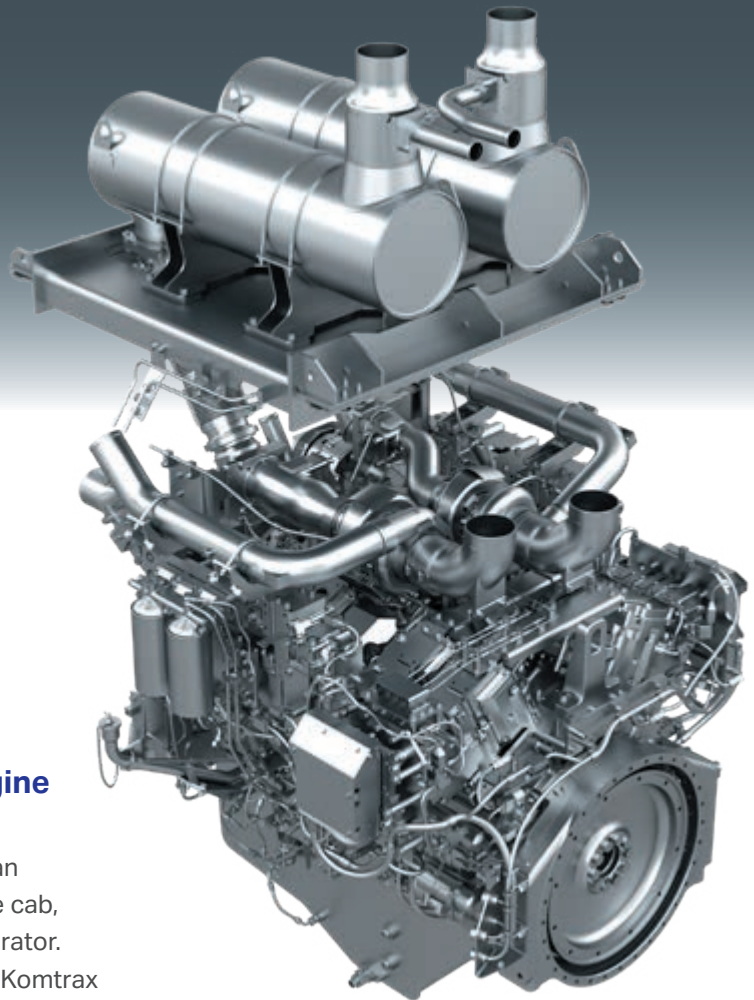

Horsepower (net)

**780 kW (1050 HP)**

## Technologies applied to new engine

### Electronic control system

Conditions of the engine are displayed via an on-board network on the monitor inside the cab, providing necessary information to the operator. Furthermore, managing the information via Komtrax Plus helps customers engage in appropriate maintenance.

## Further promotion of cleanliness and economy, efficiency improvement support

### ECO guidance

While machine is operating, ECO guidance operation tips pops up on the monitor guiding the operator to achieve better fuel efficiency.

### ECO gauge & fuel consumption gauge

The monitor screen is provided with an ECO gauge and also a fuel consumption gauge which is displayed continuously. In addition, the operator can set any desired target value of fuel consumption (within the range of the green display), enabling the machine to be operated with better fuel economy.

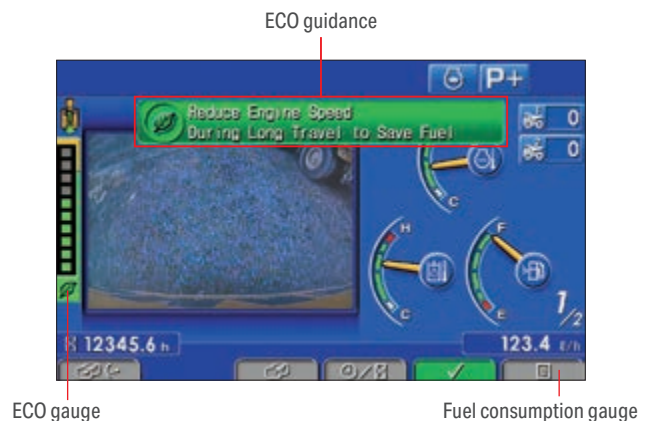



**Operation record, fuel consumption history, and ECO guidance record**

The ECO guidance menu enables the operator to check the operation record, fuel consumption history and ECO guidance record from the ECO guidance menu with a single touch, thus assisting operators with reducing total fuel consumption.

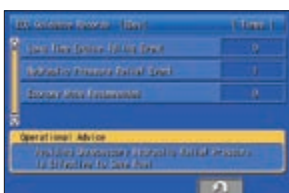

ECO guidance record

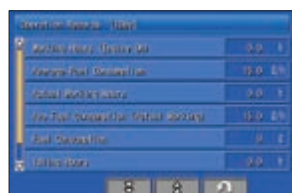

Operation record

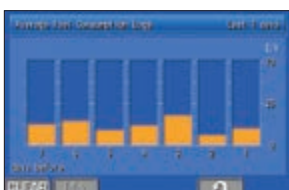

Fuel consumption history

**Auto deceleration and auto idling system**

The machine is equipped with the auto deceleration system (1400 rpm), reducing operating noise as well as fuel consumption. Longer idle time activates the auto idling system reducing further the engine idling speed for more fuel savings.

**Auto idle shutdown (adjustable)**

When the engine has been idling for certain time, the engine stops automatically to reduce unnecessary fuel consumption and exhaust emissions. The duration before the engine shutdown can be easily programmed.

**Power module packaging for ultra low-noise operation**

Noise sources such as the engine, cooling fan, and hydraulic pumps are packaged in the machinery house. Large sound absorbing blades attached on the air intake and exhaust outlet block noise transmission. Combined with the three dimension hybrid cooling fan, the machine realizes environmentally-friendly operation with amazingly low noise.



# Reliability features

## Power module

**Reduced inspection/ maintenance and overhaul man-hours achieves total cost reduction**

**Power module packaging for easy installation and removal of components**

Engine, radiator, oil cooler, hydraulic pumps and PTO are packaged within the power module. This design facilitates installation and removal of components, contributing to the reduction of maintenance transportation and overhaul hours.

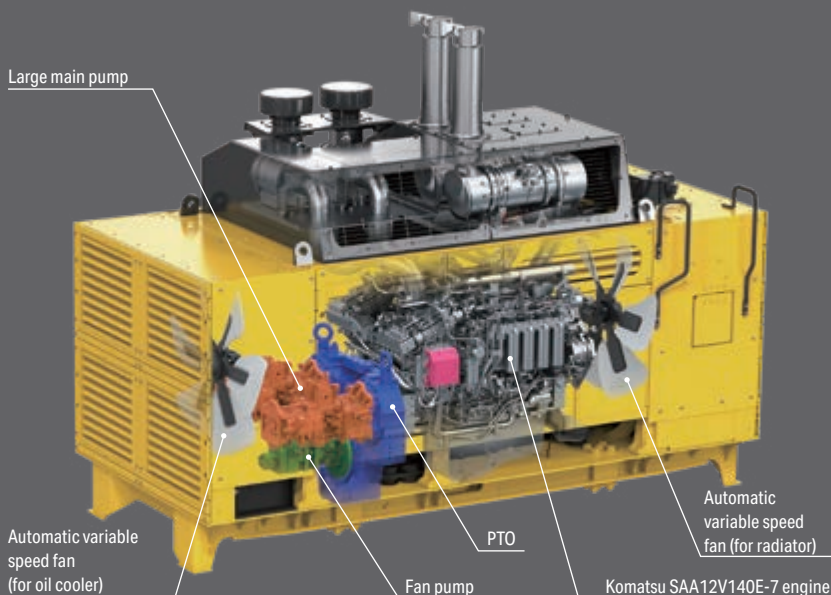

## Simple construction and larged components for easy checking and maintenance

Use of a single-engine, larged hydraulic pumps and simplified hydraulic circuit enables reduced hours required for checking and maintenance.

## High cooling efficiency machine design

Increased oil cooler capacity increases oil cooling efficiency and lowering energy requirements to maintain hydraulic system optimal operating temperature.

Heat-resistant rubber seals are used in hydraulic pumps and cylinders to achieve high durability of components. These improvements significantly extend the service life of the hydraulic system.

## Durable swing circle with triple-roller bearing

Large capacity triple-roller bearing is used for the swing circle. The swing circle endures heavy-duty excavating and loading work, and exhibits excellent durability.

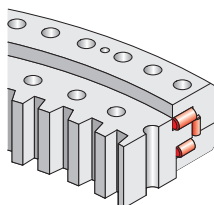

## Strengthened frame structure

Revolving frame, center frame and crawler frame are strengthened completely. The frames endure heavyduty work and exhibit excellent durability.

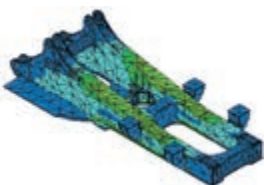

## Strengthened boom

Thanks to the newly designed integration of side plates and the shape change of the boom top casting, the boom exhibit excellent durability and is highly resistant to bending and torsional stress.

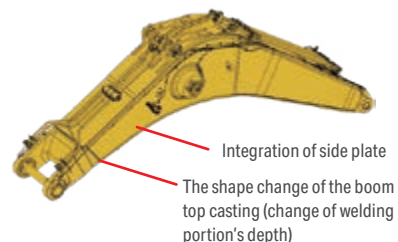

## Arm rock protector guards the arm against impact

Arm rock protector is equipped as standard. The protector guards the arm greasing piping against impact.



## Wear-resistant float pin

Boom top pin and arm top pin are floating type. Since the pin can freely rotate, it receives less friction load and exhibits excellent reliability and durability. Fixed type pin for arm top is available as option complying with operating conditions of select regions.

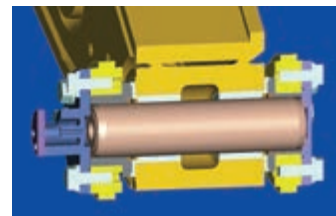



### Double sealing structure for hydraulic cylinder

Additional scraper and sub dust seal in all work equipment cylinders improves dust and dirt protection and prolongs cylinder and hydraulic system service life.

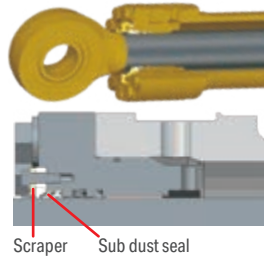

### Extended life enlarged carrier rollers size

Durable undercarriage structure with enlarged carrier roller diameter to extend service life and synchronize maintenance with other undercarriage parts.



### Sturdy guard and large track link

Travel motor and related piping is protected by a sturdy guard preventing damage caused by large rock thrust.

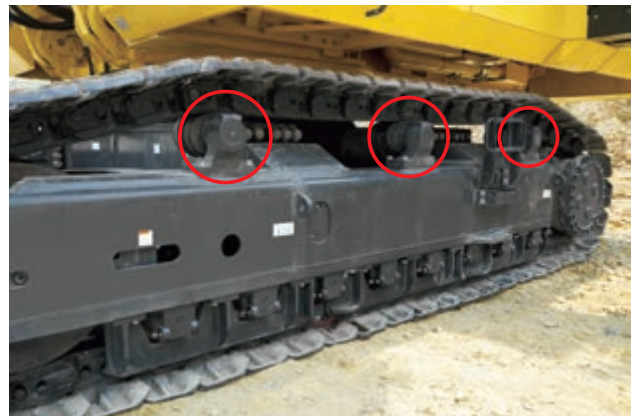

### Heavy duty bucket equipped with new tooth system [Kprime] as standard

Reliability with intuitive handling and higher productivity by Kprime features.



# Safety features

## Operator cab specially designed for mining

Operator cab provides a comfortable working environment. Sturdy cab of solid construction, with top guard conforms to OPG level 2 (ISO 10262).



## 45° access stairway

The machine is equipped with a hydraulic operated stairway. All stairways of this machine are 45° so that operators can access easily from ground to the cab.



45° access stairway

45° access hydraulically operated stairway

## Seat belt caution indicator

Lights up when seat belt is not applied.



## Lock lever auto lock function

If the work equipment lever is not in the neutral position when the hydraulic lock lever is released, the equipment is automatically stopped. The auto stop state is shown on the monitor screen.

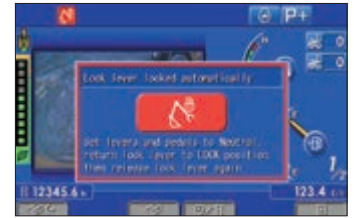

## Engine shutdown secondary switch

Installed at the console and used to turn "OFF" the engine.



## Emergency engine stop switch & fuel cut-off lever

Three emergency engine stop switches are provided as standard equipment. One installed in the cab console and others are on the power module. Engine start lock function is used during maintenance work. Optional remote emergency engine stop switches which can be operated from the ground is also available.

In addition, a fuel cut-off lever on the revolving frame can be used to stop the engine from the ground.

Emergency engine stop switch (standard)



**Safety equipment**

<p><b>Slip-resistant plates</b></p>  <p><b>LED working light</b></p> <p><b>LED maintenance light</b></p> <ul style="list-style-type: none"> <li>• Inside of cab base</li> <li>• Inside of power module (3 places)</li> </ul> <p><b>Interconnected horn and flashing light</b></p> 	<p><b>Rope ladder for emergency egress</b></p>  <p><b>Lock lever</b></p> <p><b>Dual rearview mirror</b></p> <p><b>Wide catwalk with handrail</b></p> <p><b>Hammer for emergency escape</b></p> <p><b>Fire extinguisher (optional)</b></p> <p><b>Travel alarm</b></p> <p><b>Seat belt retractable</b></p> <p><b>Beacon (optional)</b></p>
--	---



Fuel cut-off lever



Emergency engine stop switch (optional)

# Comfort features

## Comfortable working space

### Excellent operational visibility

Wide front and side windshields coupled with integrated console provides excellent visibility for safe and comfortable operation.



### Low noise and low vibration with cab damper mounting

Integral structure of cab and damper mounts, in combination with power module packaging, attain outstanding low noise and vibration in the cab equivalent to passenger cars.

### Spacious and comfortable cab design pressurized cab

The large cab exclusively designed for mining application offers maximum comfort even at extreme climate and long operation hours. The cab with improved air tightness is pressurized to prevent dust from entering. Combined with a large capacity twin air conditioner that cools and heats the cab effectively, ample and comfortable operating environment is attained.

### Comfortable air suspension seat with heater

The seat with air suspension reduces the vibration transmitted to the operator. Depending on the operator's weight and physique, the cushion can be adjusted and the seat can slide fore/aft and vertically. The redesigned seat with integrated arm rest and control console significantly improves operating comfort.

## Standard equipment



- 1 Cup holder
- 2 Air conditioner control panel
- 3 Cigarette lighter (24 V)
- 4 2 × 12 V socket
- 5 Magazine box
- 6 Handling radio
- 7 Ashtray
- 8 Auxiliary input jack

### Trainer's seat diagonally behind the operator

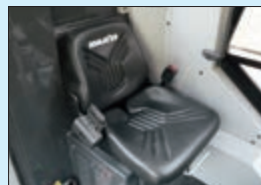

### Floor mat

Dual rear view mirror and as option, heated mirrors are also available.



### High back air suspension seat with heater

### Sun shield

Defroster  
(Conform to the ISO 10263-5)

### LED room light

Sliding window glass  
(left side)

### Utility box

Large twin wiper

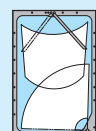

# Maintenance features

## Advanced layout for easy checking and maintenance

Catwalk surrounding the power module and center walkway provides easy access to the inspection and maintenance points.

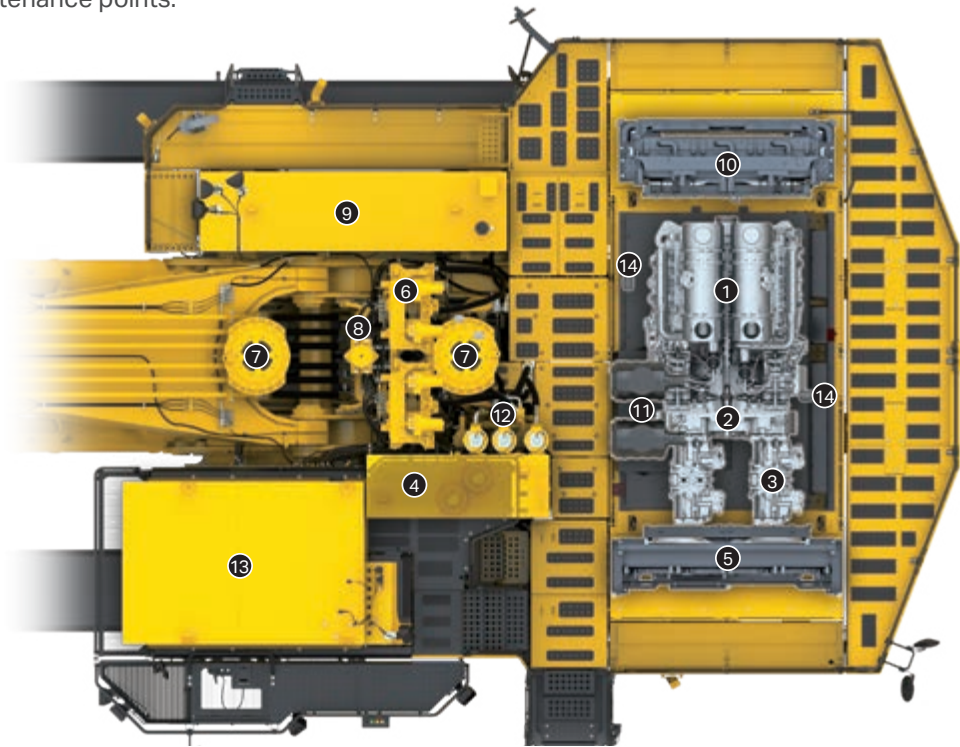

- ① Engine
- ② PTO
- ③ Hydraulic pump
- ④ Hydraulic tank
- ⑤ Oil cooler
- ⑥ Control valve
- ⑦ Swivel motor
- ⑧ Swivel joint
- ⑨ Fuel tank
- ⑩ Radiator
- ⑪ Air cleaner
- ⑫ Hydraulic oil filter
- ⑬ Cab
- ⑭ Maintenance light

## Centralized filters

Centralized filters contribute to easy maintenance.

## Remote drain piping enables drainage from the ground

Remote drain piping provided to drain hydraulic oil, PTO oil, engine oil and coolant enable performing drainage work from the ground.

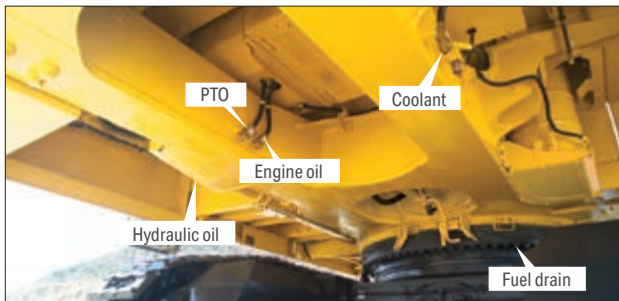

## Service center (optional)

Collective arrangement of drain and filler ports for fuel, oil, grease and coolant on the service center, which is hydraulically moved up and down, makes quick servicing from the ground possible.



## Automatic greasing system

Greasing work equipment and bucket is fully automated. Since the system carries out automatic greasing at regular time intervals, greasing is hassle-free.

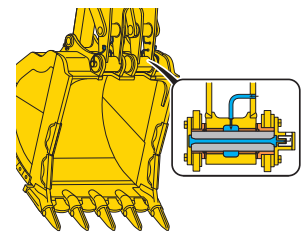

## Large fuel tank

3400 l large fuel tank enables continuous operation for 24 hours.

## Large capacity grease tank easy-to-supply refill piping (optional)

The machine is equipped with 200 l large capacity grease tank enough to perform 24 hours operation. An optional remote refill port with in line filter enables resupply of clean grease to the tank from the ground.



### Step light with timer and maintenance light

Step light with timer provides light for 90 seconds to allow the operator to get off the machine. The step lights can also be constantly lit for maintenance use.



### Battery isolator and starting motor isolator

When inspection and maintenance or storing the machine long term, the isolators serve to disconnect both positive and negative terminals of the battery and starting motor.



### Jump start receptacle (optional)

Jump start receptacle allows starting engine from external power source.



### Easy cleaning of radiator and oil cooler

The hydraulically driven fan can be reversed to facilitate cleaning of the cooling unit. In addition, this feature contributes to reducing warm-up time in low temperatures.

### Easy maintenance of air conditioner units

Enlarged unit space, easy to check and exchange air conditioner units.



### Long-life oil, filter

Uses high-performance filtering materials and long-life oil. Extends the oil and filter replacement interval.

Engine oil & engine oil filter	every	<b>500</b> hours
Fuel main filter	every	<b>1000</b> hours
Hydraulic oil filter	every	<b>1000</b> hours
Hydraulic oil	every	<b>5000</b> hours

### Coolant filter

Filters out contaminants to maintain high cooling efficiency and prevents water pump and core clogging related failures.



### Large capacity fuel prefilter (with water separator)

Removes water and dust in the fuel and prevents fuel system troubles.



The filtering capacity of water and dust has been increased compared to the conventional filter.

### Hydraulic return filter clog detection function

Recommends filter exchange and prevents catastrophic damage of hydraulic system by informing operator the clogging of hydraulic return filter. The signal can be monitored via the Komtrax Plus.



### Monitor function

Controller monitors engine oil level, coolant temperature, battery charge and air clogging, etc. When an abnormality is detected, informative failure details is displayed in the monitor display guiding the operator on the best course of action.

### Trouble data memory function

Monitor stores abnormalities for effective troubleshooting.



### Maintenance information

#### "Maintenance time caution lamp" display

When the remaining time to maintenance becomes less than 30 hours\*, the maintenance time monitor appears. Pressing the F6 key switches the monitor to the maintenance screen.

\* The setting can be changed within the range between 10 and 200 hours.

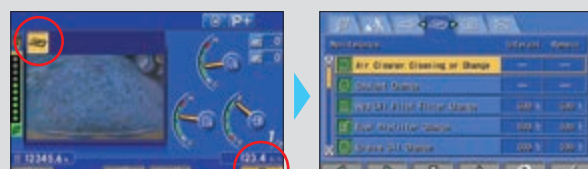

Maintenance screen

# ICT & KOMTRAX

Large high resolution Liquid Crystal Display (LCD) monitor



## Machine monitor with evolutionary interface

The interface has been redesigned to enable the necessary information to be read and understood more easily, while retaining the maneuverability of previous model. A rear view camera image has been added to the default main screen. The interface has a function that enables the main screen to be switched, thus enabling the optimum screen for the particular work situation to be displayed.

### Indicators

- |                            |                                    |                              |
|----------------------------|------------------------------------|------------------------------|
| 1 Auto-decelerator         | 7 Engine coolant temperature gauge | 12 Engine oil pressure gauge |
| 2 Working mode             | 8 Hydraulic oil temperature gauge  | 13 Service meter / Clock     |
| 3 Camera direction display | 9 Fuel gauge                       | 14 Fuel consumption gauge    |
| 4 Camera display           | 10 PTO oil temperature gauge       | 15 Guidance icon             |
| 5 Truck counter            | 11 Engine oil temperature gauge    | 16 Function switches         |
| 6 ECO gauge                |                                    |                              |

### Basic operation switches

- |                         |                 |                 |
|-------------------------|-----------------|-----------------|
| 1 Auto-decelerator      | 3 Heavy lift    | 5 Wiper         |
| 2 Working mode selector | 4 Buzzer cancel | 6 Window washer |

## Visual user menu

Pressing the F6 key on the main screen displays the user menu screen. The menus are grouped for each function, and use easy-to-understand icons which enable the machine to be operated intuitively.



- 1 Energy saving
- 2 Machine settings
- 3 Maintenance
- 4 Monitor setting
- 5 Mail check

## Switchable main screen

The main screen can be switched over every time by pressing the F3 key.

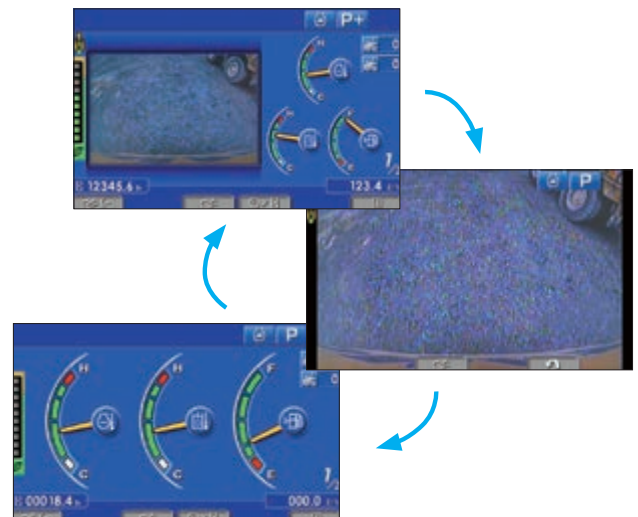

10 Inch touch panel KomVision monitor



**KomVision, all around monitoring system**

The 7-camera system installed on PC2000-11R allows quick confirmation on work area safety at a glance to prevent collision. The birds eye view image is displayed in the 10 inch KomVision monitor and a dedicated rear view display on the machine monitor.



**Equipment management support**

Komtrax Plus enables expanded monitoring of the fleet via satellite and wireless LAN. Users can analyze "machine health" and performance from a remote location, on a near-real time basis. This includes component condition and trend data. By making this critical information readily accessible, Komtrax Plus is an effective tool in maximizing productivity and lowering operating costs.



**KOMTRAX Plus**

**Monitors large machines' health and supports customers' machine management.**

**Support for machine management**

Komtrax Plus is a management system for large machines. With this system, you can grasp "health condition" and "operating condition" of the machines from distant places via satellite communication, and accordingly you can prevent machine troubles and streamline the machine management.

**Machine management with Komtrax Plus**

- **Maintenance management:** Manage maintenance schedule and failure prevention maintenance
- **Machine management:** Check lists of jobsites, service meter readings, etc.
- **Operation management:** Check operating condition of each machine
- **Check machine locations:** Check detailed machine sites on map
- **Support in energy saving operation:** Check fuel consumption and CO<sub>2</sub> emissions, and make energy saving operation support report
- **Make forms:** Download displayed data and use them as forms







**Energy saving operation support report**

It is possible to provide energy saving operation support report and other information useful to customers on the basis of work information such as fuel consumption, idling time, etc.

# Komatsu brand bucket

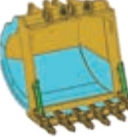
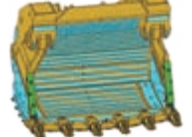
The recommended material density for each bucket is listed below. Using the bucket above the recommended material density may result to decreased machine durability.

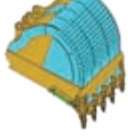
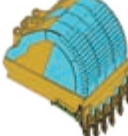
○: Material density up to 1.8 t/m<sup>3</sup> ○: Material density up to 1.5 t/m<sup>3</sup> and easy digging such as well blasted material or loose soils. ×: Not applicable

	Backhoe bucket	Backhoe bucket	Backhoe bucket	Loading shovel bucket
Bucket shape				
Wear plate location				
Bucket capacity ISO 7451 m <sup>3</sup>	12.0	13.7	14.0	11.0
Lip shape	Straight	Straight	Spade	Spade
Bucket width with shroud/ bucket lip width mm	2670 / 2890	2790 / 3020	2790 / 3020	3290 / 3510
Tooth type	Kprime P200	Kprime P200	Kprime P200	Kprime P200
Number of teeth	5	5	6	6
Side shroud	Yes	Yes	Yes	Yes
Backhoe 8.7 m boom 3.9 m arm	○	○	○	×
Loading shovel (L/S) 6.0 m L/S boom 4.5 m L/S arm	×	×	×	○
Excavating condition and material	Heavy Duty	Heavy Duty	Heavy Duty	General-purpose



## PC200-11R bucket equipped with new tooth system "Kprime" as new standard



New intuitive locking system

- Secure torque after multiple use
- Push out features make removal tooth easier

Redesigned wear cap

- Has interior stabilizing up

New shape tooth

- Increase wear volume
- Better penetration

Adapter:  
New fit surfaces

- Provide better tooth fit

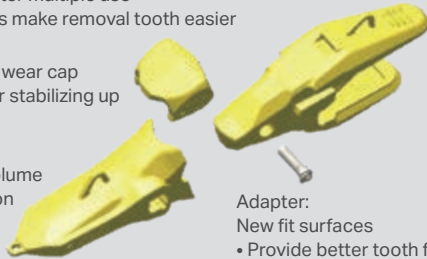

### 1 Safety enhancements

- Simple ¼ rotation to lock/unlock
- Push out features make removal tooth easy
- Audible "Clack" sound indicating when locked

### 2 Reliability

- New fit surfaces provide better tooth fit\*
- Redesigned wear cap with improved internal stability\*
- Locking system without torque loss after repeated use

### 3 Productivity

- 10 - 15% increased usable in wear material\*
- Wear indicators on wear cap and pin
- Designed to stay sharp for the life of tooth\*

\*compared to our conventional products

## Installation

### ▶ Step 1

Place tooth onto adapter.

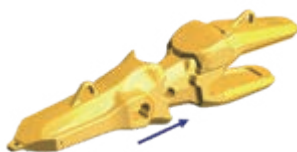

### ▶ Step 2

Insert pin, making sure it is in the unlocked position.



### ▶ Step 3

Rotate the pin locking shaft clockwise 90° to lock teeth into position.



Unlocked

### ▶ Step 4

'Clack' sound indicates locked position.



Locked

## Removal

Rotate the shaft counterclockwise 90° and 'Push out features' to help dislodge the pin.



# Komatsu total support



## Komatsu total support

To keep your machine available and minimize operation cost when you need it, Komatsu distributor is ready to provide a variety of supports before and after procuring the machine.

### Fleet recommendation

Komatsu distributor can study the customer's job site and provide the most optimum fleet recommendation with detailed information to meet all of your application needs when you are considering to buy new machines or replace the existing ones from Komatsu.



### Product support

Komatsu distributor gives the proactive support and secures the quality of the machinery that will be delivered.

### Parts availability

Komatsu distributor is available for emergency inquiry by the customers for genuine, quality guaranteed Komatsu parts.

### Technical support

Komatsu product support service (technical support) is designed to help customer. Komatsu distributor offers a variety of effective services to show how much Komatsu is dedicated to the maintenance and support of Komatsu machine.

- Preventive Maintenance (PM) clinic
- Oil & wear analysis program
- Undercarriage inspection service, etc.

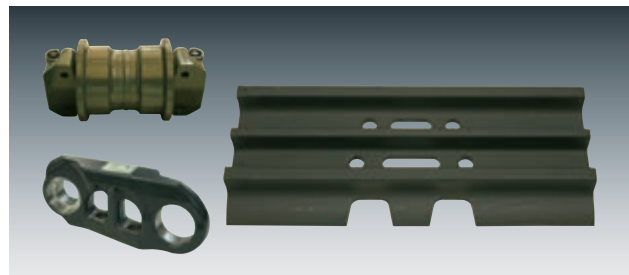

### Repair & maintenance service

Komatsu distributor offers quality repair and maintenance service to the customer, utilizing and promoting Komatsu developed programs.

### Komatsu Reman (remanufactured) components

Komatsu Reman products are the result of the implementation of the Komatsu global policy which establishes and agrees to reduce the owning, operating and total Life Cycle Costs (LCC) to Komatsu's customer through high quality, prompt delivery and competitively priced in own remanufactured products (QDC).



# Specifications



## Engine

Model ..... Komatsu SAA12V140E-7  
 Type ..... 4-cycle, water-cooled, direct injection  
 Aspiration ..... Turbocharged, aftercooled  
 Number of cylinders ..... 12  
 Bore ..... 140 mm  
 Stroke ..... 165 mm  
 Piston displacement ..... 30.48 l  
 Governor ..... All-speed, electronic  
 Horsepower:  
   SAE J1995 ..... Gross 794 kW / 1060 HP  
   ISO 9249 / SAE J1349 ..... Net 780 kW / 1050 HP  
   Rated rpm ..... 1800 rpm  
 Fan drive type ..... Hydraulic

\* Net horsepower at the maximum speed of radiator cooling fan is 702 kW / 942 HP.  
 U.S. EPA Tier 2 emission equivalent.



## Hydraulic system

Type ..... Open-center load-sensing system  
 Number of selectable working modes ..... 3  
 Main pump:  
   Type ..... Variable-capacity piston pumps  
   Pumps for ..... Boom, arm, bucket, swing, and travel circuits  
   Maximum flow:  
     For attachment, swing and travel ..... 2317 l/min  
     For fan drive ..... 324 l/min  
 Hydraulic motors:  
   Travel ..... 2 × axial piston motors with parking brake  
   Swing ..... 2 × axial piston motors with swing holding brake  
 Relief valve setting:  
   Attachment circuits  
     Backhoe ..... 29.4 MPa / 300 kgf/cm<sup>2</sup>  
     Travel circuit ..... 32.9 MPa / 335 kgf/cm<sup>2</sup>  
     Swing circuit ..... 29.4 MPa / 300 kgf/cm<sup>2</sup>  
     Pilot circuit ..... 3.2 MPa / 33 kgf/cm<sup>2</sup>  
 Hydraulic cylinders:  
 (Number of cylinders-bore × stroke)  
   Backhoe  
     Boom ..... 2 – 300 mm × 2647 mm  
     Arm ..... 2 – 250 mm × 2134 mm  
     Bucket ..... 2 – 200 mm × 2170 mm



## Drives system

Travel gear ..... Planetary gear  
 Gradeability ..... 66%  
 Maximum travel speed ..... 2.7 km/h  
 Parking brake ..... Oil disk brake



## Swing system

Swing gear ..... 2 × Planetary gears  
 Swing circle lubrication ..... Grease-bathed  
 Swing holding brakes ..... Oil disc brakes  
 Swing speed ..... 4.8 rpm



## Undercarriage

Track adjuster ..... Grease  
 No. of shoes (each side) ..... 49  
 No. of carrier rollers (each side) ..... 3  
 No. of track rollers (each side) ..... 8



## Coolant and lubricant capacity (refill)

Fuel tank ..... 3400 l  
 Radiator ..... 190 l  
 Engine ..... 128 l  
 Travel gear (each side) ..... 85 l  
 Swing drive ..... 30 × 2 l  
 Hydraulic tank ..... 1300 l  
 PTO ..... 40 l



## Operating weight (approximate)

**Backhoe**  
 Operating weight, including 8700 mm boom, 3900 mm arm, ISO 7451 heaped 12.0 m<sup>3</sup> general purpose backhoe bucket, lubricant, coolant, full fuel tank, and the standard equipment.

Shoes	PC2000-11R	
	Operating weight	Ground pressure
<b>Double grouser 810 mm</b>	201400 kg	191.2 kPa 1.95 kgf/cm <sup>2</sup>
<b>Triple grouser 1010 mm</b>	205500 kg	157 kPa 1.60 kgf/cm <sup>2</sup>

**Loading shovel**  
 Operating weight, including 5950 mm boom, 4450 mm arm, ISO 7451 heaped 11.0 m<sup>3</sup> bucket, operator, lubricant, coolant, full fuel tank, and the standard equipment.

Shoes	PC2000-11R	
	Operating weight	Ground pressure
<b>Double grouser 810 mm</b>	196400 kg	187 kPa 1.91 kgf/cm <sup>2</sup>



## Dimensions

Unit: mm

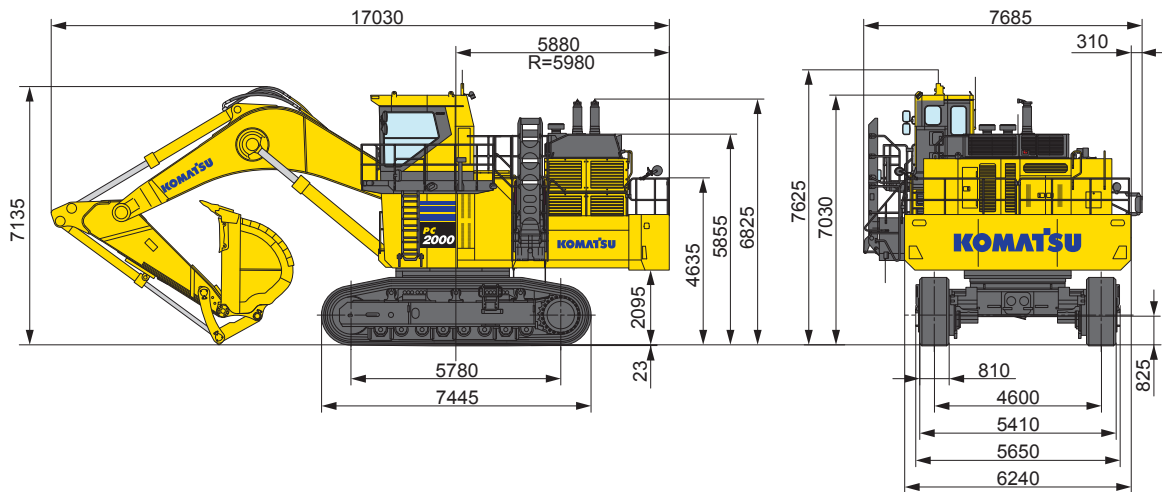

## Working range

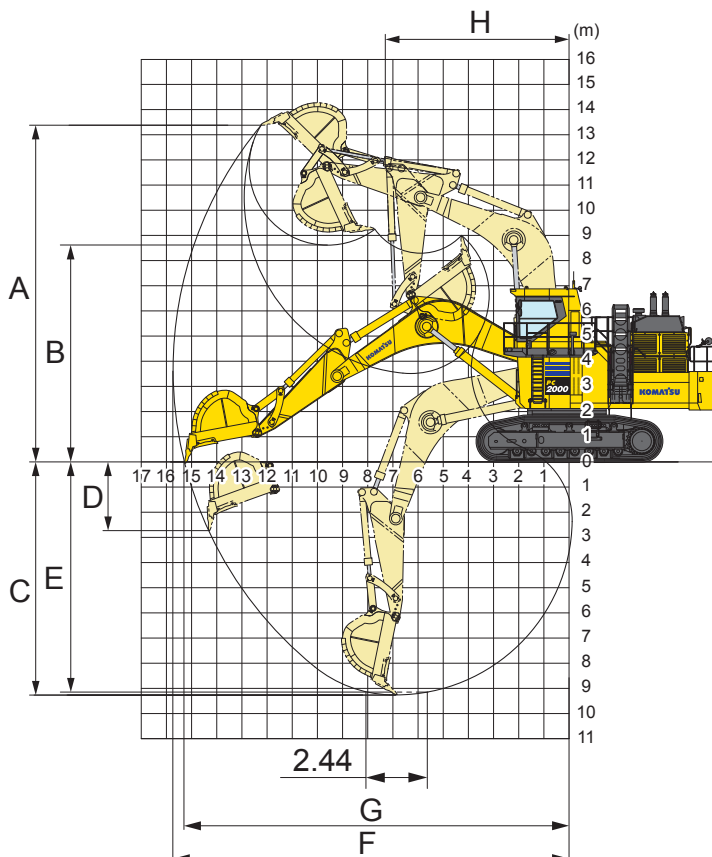

<b>Boom length</b>	<b>8.7 m</b>
<b>Arm length</b>	<b>3.9 m</b>
<b>A</b> Max. digging height	13390 mm
<b>B</b> Max. dumping height	8640 mm
<b>C</b> Max. digging depth	9245 mm
<b>D</b> Max. vertical wall digging depth	2765 mm
<b>E</b> Max. digging depth of cut for 2440 mm level	9125 mm
<b>F</b> Max. digging reach	15780 mm
<b>G</b> Max. digging reach at ground level	15305 mm
<b>H</b> Min. swing radius	7500 mm
Bucket digging force (SAE J 1179)	626 kN 63800 kgf
Arm crowd force (SAE J 1179)	586 kN 59700 kgf
Bucket digging force (ISO 6015)	697 kN 71100 kgf
Arm crowd force (ISO 6015)	598 kN 61000 kgf



## Loading shovel dimensions

Unit: mm

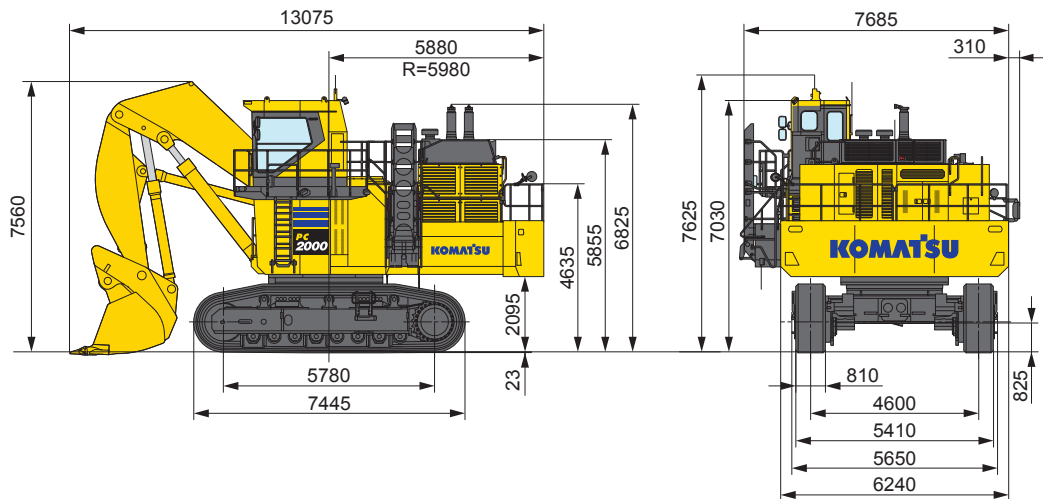

## Loading shovel working range

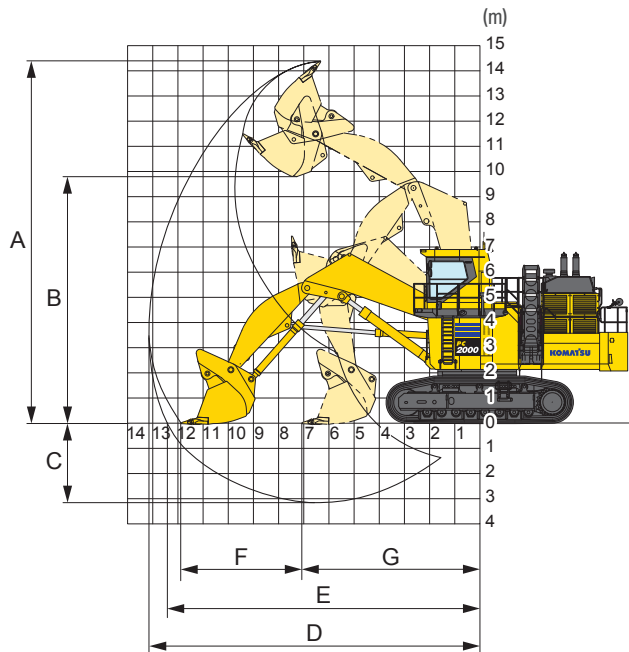

Type of bucket		Bottom dump
Capacity-heaped		11.0 m <sup>3</sup>
A	Max. cutting height	14450 mm
B	Max. dumping height	9665 mm
C	Max. digging depth	3190 mm
D	Max. digging reach	13170 mm
E	Max. digging reach at ground level	11940 mm
F	Level crowding distance	4850 mm
G	Min. crowd distance	7090 mm
Bucket digging force		721 kN 73500 kgf
Arm crowd force		755 kN 77000 kgf



**Transportation guide**

Specifications shown include the following equipment:

Backhoe: boom **8700 mm** arm **3900 mm** bucket **12.0 m<sup>3</sup>** shoes **810 mm** double grouser

Loading shovel: boom **5950 mm** arm **4450 mm** bucket **11.0 m<sup>3</sup>** shoes **810 mm** double grouser

**Work equipment assembly – backhoe**

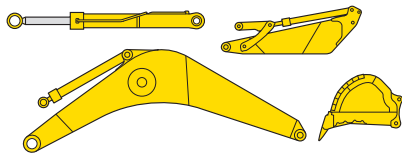

	Length (mm)	Width (mm)	Height (mm)	Weight (t)
Boom	9170	2065	3195	21.5
Arm	5495	1605	2055	13.0
Bucket	3540	2890	2320	10.0

	Length (mm)	Weight (t)	Quantity
Boom cylinder	4270	2.1	2

**Work equipment assembly – loading shovel**

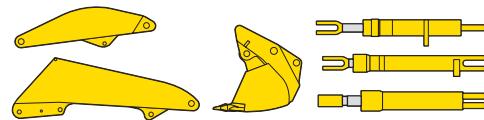

	Length (mm)	Width (mm)	Height (mm)	Weight (t)
Boom	6400	1740	2000	11.8
Arm	4900	1450	1700	9.5
Bucket	3500	3510	2920	14.4

	Length (mm)	Weight (t)	Quantity
Boom cylinder	4265	1.90	2
Arm cylinder	3370	1.05	2
Bucket cylinder	3350	1.10	2

**Cab**

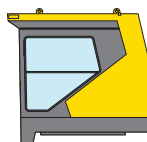

**Cab base**



**Revolving frame**

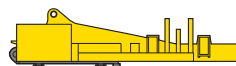

**Power module**

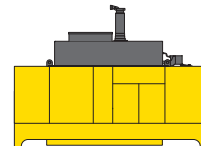

**Fuel tank**

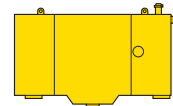

Length (mm)	2885	2100	7575	5215	3100
Width (mm)	1880	2000	3180	2455	875
Height (mm)	2520	2700	2640	3320	2070
Weight (t)	2.0	2.6	26.5	16.4	2.14

**Counterweight**



**Center frame**

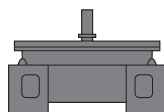

**Undercarriage**

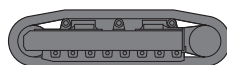

**Hydraulic tank**



**Left floor**

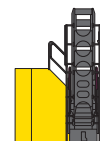

Length (mm)	6240	3815	7435	1860	2510
Width (mm)	1115	3190	1720	1115	3280
Height (mm)	1505	2210	1920	2085	3150
Weight (t)	24.8	18.1	26.0 x 2	1.75	2.3

**Others**

Catwalk, step, handrail, small removed parts, etc.



## Lifting capacity with lifting mode

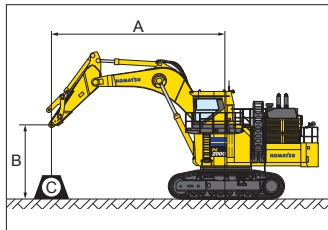

### PC2000-11R

Equipment:

- Boom: 8.7 m
- Arm: 3.9 m
- Without bucket
- Track shoe width: 810 mm

A: Reach from swing center

B: Arm top pin height

C: Lifting capacity

Cf: Rating over front

Cs: Rating at side

⊗: Rating at maximum reach

### Heavy Lift ON

B \ A	⊗ MAX		10.7 m		9.1 m		7.6 m		6.1 m		4.6 m		3.0 m	
	Cf	Cs	Cf	Cs	Cf	Cs	Cf	Cs	Cf	Cs	Cf	Cs	Cf	Cs
7.6 m	*36170 kg	*36170 kg	*45180 kg	45010 kg	*50150 kg	*50150 kg								
6.1 m	*36820 kg	33710 kg	*47020 kg	43680 kg	*53720 kg	*53720 kg	*63730 kg	*63730 kg						
4.6 m	*38160 kg	32100 kg	*49000 kg	42220 kg	*57310 kg	54390 kg	*69770 kg	*69770 kg						
3.0 m	40370 kg	31370 kg	*50720 kg	40760 kg	*60330 kg	52050 kg	*74340 kg	68210 kg						
1.5 m	40740 kg	31550 kg	51370 kg	39660 kg	*61780 kg	50410 kg	*76020 kg	66000 kg						
0.0 m	42300 kg	32690 kg	50620 kg	38950 kg	*61480 kg	49370 kg	*75120 kg	64810 kg	*73340 kg	*73340 kg				
-1.5 m	*42920 kg	35090 kg	*48270 kg	38710 kg	*59060 kg	48950 kg	*71680 kg	64430 kg	*87840 kg	*87840 kg	*57620 kg	*57620 kg		
-3.0 m	*42140 kg	39440 kg			*53750 kg	49160 kg	*65310 kg	64760 kg	*78920 kg	*78920 kg	*86960 kg	*86960 kg		
-4.6 m	*39560 kg	*39560 kg			*42230 kg	*42230 kg	*53820 kg	*53820 kg	*64740 kg	*64740 kg	*75340 kg	*75340 kg		
-6.1 m														

\* Load is limited by hydraulic capacity rather than tipping. Ratings are based on ISO standard No.10567. Rated loads do not exceed 87% of hydraulic lift capacity or 75% of tipping load.

### Heavy Lift OFF

B \ A	⊗ MAX		10.7 m		9.1 m		7.6 m		6.1 m		4.6 m		3.0 m	
	Cf	Cs	Cf	Cs	Cf	Cs	Cf	Cs	Cf	Cs	Cf	Cs	Cf	Cs
7.6 m	*32770 kg	*32770 kg	*40210 kg	*40210 kg	*44790 kg	*44790 kg								
6.1 m	*33350 kg	*33350 kg	*41790 kg	*41790 kg	*47880 kg	*47880 kg	*56950 kg	*56950 kg						
4.6 m	*34570 kg	32100 kg	*43500 kg	42220 kg	*51000 kg	*51000 kg	*62210 kg	*62210 kg						
3.0 m	*36700 kg	31370 kg	*44960 kg	40760 kg	*53600 kg	52050 kg	*66140 kg	*66140 kg						
1.5 m	*37840 kg	31550 kg	*45560 kg	39660 kg	*54800 kg	50410 kg	*67530 kg	66000 kg						
0.0 m	*37930 kg	32690 kg	*44970 kg	38950 kg	*54450 kg	49370 kg	*66620 kg	64810 kg	*66940 kg	*66940 kg				
-1.5 m	*37760 kg	35090 kg	*42560 kg	38710 kg	*52200 kg	48950 kg	*63440 kg	*63440 kg	*77770 kg	*77770 kg	*52490 kg	*52490 kg		
-3.0 m	*36960 kg	*36960 kg			*47340 kg	*47340 kg	*57620 kg	*57620 kg	*69640 kg	*69640 kg	*79430 kg	*79430 kg		
-4.6 m	*34470 kg	*34470 kg			*36870 kg	*36870 kg	*47160 kg	*47160 kg	*56740 kg	*56740 kg	*65780 kg	*65780 kg		
-6.1 m														

\* Load is limited by hydraulic capacity rather than tipping. Ratings are based on ISO standard No.10567. Rated loads do not exceed 87% of hydraulic lift capacity or 75% of tipping load.



## Standard equipment

### Engine and related items

- Air cleaner, double element dry
- Air pre-cleaner
- Automatic engine warm-up system
- Coolant filter
- Electric priming pump for fuel
- Engine, Komatsu SAA12V140E-7 turbocharged
- Fuel pre-filters with water separators
- Two radiator and oil cooler, reversible

### Electrical system

- Alternators, 24 V/2 × 90 A
- AM/FM Radio
- Auto decelerator and auto idling system
- Auto idle shutdown (adjustable)
- Batteries, 4 × 12 V/220 Ah (20-hour rate capacity)
- Battery isolator and starting motor isolator
- Circuit breakers
- Horn interconnected with warning light
- Ladder operating alarm
- LED maintenance light
- LED step lights with timer
- LED working lights, 4 boom, 4 cab base, 3 fuel tank top front, 1 left front and 1 left under cab side catwalk, 2 rear
- Lighting switches instrument panel
- Lock lever auto-lock
- Starting motors, 2 × 11 kW

### Guards and covers:

- Center frame undercover
- Dustproof net for radiator and oil cooler
- Power module under cover
- Pump/engine room partition wall
- Travel motor guard

### Drive system

- Planetary travel gear with axial piston motor
- Travel parking brake

### Hydraulic system

- 4 variable displacement piston pumps (2 tandem pumps) for work equipment, travel and swing, 2 variable displacement piston pumps (1 tandem pump) for fan drive
- Control levers and pedals for travel with Pressure Proportional Control (PPC) system
- Control levers for work equipment and swing with PPC system
- Drain-filters for pumps & motors
- Electric open-center load sensing system
- Four control valves (two integrated valves) for work equipment, swing and travel
- Heavy lift mode
- High-pressure in-line oil filters
- Oil cooler
- One axial piston motor per track for travel with counterbalance valve
- Optimized Electronic valve control for smooth compound movement
- Shockless boom control
- Two axial piston motors for swing with single stage relief valve
- Two-mode pressure setting for boom

### Operator's cab

- Automatic air conditioners (twin)
- Auxiliary input (3.5 mm jack)
- Built-in top guard conforming to OPG level 2 (ISO 10262)
- Heated, high-back air-suspended seat
- KomVision, all round monitoring system
- Large damper mounted and pressurized mining shovel cab with large windshield, lockable door, large twin wipers and washers, floor mats, cigarette lighter, ashtray and cup holders
- Large high resolution LCD color monitor
- Lock lever
- Rearview monitoring system
- Seat belt, retractable, 78 mm
- Seat belt indicator
- Sun shield
- Trainer's seat

### Other

- 55 °C specification
- Automatic swing holding brake
- Dual rearview mirrors
- Emergency engine stop switch and fuel cut-off lever
- Fuel tank, 3400 l
- Fully-automatic greasing system with 200 l tank
- Fully hydraulic operated stairway and full 45° access to cab
- General tool kit
- Komtrax Plus (vehicle health monitoring system)
- Manual grease gun for track adjuster
- PM tune-up service connection
- Rear reflectors
- Sattellite communication system for Komtrax Plus (Iridium)
- Slip-resistant plates
- Tie off point
- Travel alarm
- Wide catwalk and large handrail with foot guard
- Wireless LAN antenna for Komtrax Plus

### Undercarriage

- 810 mm double grouser shoes
- 8 track rollers/3 carrier rollers (each side)
- Hydraulic idler cushion with shock absorbing accumulator
- Track roller guard (separate type)



## Optional equipment

- 1010 mm triple grouser shoes
- 3900 mm backhoe arm
- 8700 mm backhoe boom
- 4450 mm loading shovel arm
- 5950 mm loading shovel boom
- Additional fuse for electric power supply
- Beacon, 2 (cab top, engine hood)
- Bluetooth® radio with USB

- Coolant heater, fuel combustion type
- Electrical engine oil pan heater and coolant heater
- Emergency engine stop switch (ground access)
- Fire extinguisher
- Full front guard, OPG level 2 (ISO 10262)
- Full length track roller guards

- Grease refill system
- Heated mirror
- Heavy-duty rock bucket
- Jump start receptacle
- Maintenance free battery
- Sattellite communication system for Komtrax Plus (ORBCOMM)
- Service center system

The Bluetooth® word mark and logos are registered trademarks owned by Bluetooth SIG, Inc. and any use of such marks by Komatsu Group is under license.  
Other trademarks and trade names are those of their respective owners.  
Up to 20% blended biodiesel fuel and paraffine fuel can be used. Please consult your Komatsu distributor for detail.

---

Your Komatsu partner:

**KOMATSU**

[komatsu.com](https://www.komatsu.com)