

KOMATSU

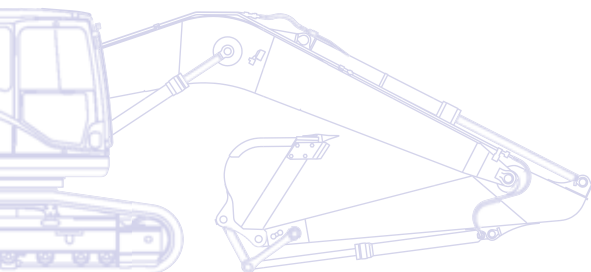

Hydraulic Excavator

PC130-8



ENGINE POWER
72,0 kW / 96,6 HP @ 2.200 rpm

OPERATING WEIGHT
12.800 - 13.485 kg

BUCKET CAPACITY
max. 0,8 m³

Walk-Around

The Komatsu Dash 8 crawler excavators set new worldwide standards for construction equipment. Operator safety and comfort is a focal point in their design, and their outstanding performance and specifications will contribute directly to the success of your business. With standard auxiliary hydraulic systems and quick-coupler power lines, these machines are ready to take on any job, whenever and wherever you need it done. Safely rely on Komatsu's 80 years of experience and commitment to Quality and Durability: your Dash 8 crawler excavator will quickly become your number one business partner.

Powerful and environmentally friendly

- Low consumption ecot3 engine
- Komatsu integrated hydraulic system
- Eco-gauge and idle caution
- Exceptional drawbar pull and steering force

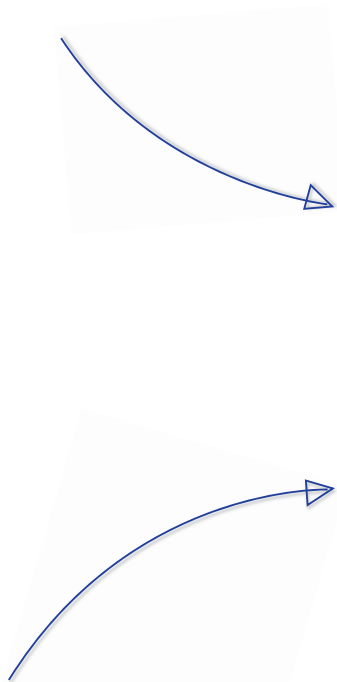

Total versatility

- Ideal for a wide range of applications
- 5 working modes
- Wide choice of options
- Built-in versatility

PC130-8

ENGINE POWER
72,0 kW / 96,6 HP @ 2.200 rpm

OPERATING WEIGHT
12.800 - 13.485 kg

BUCKET CAPACITY
max. 0,8 m³

Highest safety standards

- Safe SpaceCab™
- Rear view camera
- Optimal jobsite safety
- Safe access, easy maintenance
- Falling Object Protection System (FOPS) optional



First-class operator comfort

- Wide, spacious cab
- Low noise design
- Low vibration levels
- Pressurised cab
- Large, widescreen TFT monitor panel



KOMTRAX

Komatsu Satellite
Monitoring System

Quality you can rely on

- Reliable and efficient
- Rugged design
- Komatsu-quality components
- Extensive dealer support network

Total Versatility

Ideal for a wide range of applications

Powerful and precise, the Komatsu PC130-8 is equipped to efficiently carry out any task your business requires. On big sites or small, for digging, trenching, landscaping or site preparation, the Komatsu original equipment hydraulic system always ensures maximum productivity and control.

5 working modes

Power, Lifting, Breaker, Attachment, and Economy.

The PC130-8 features 5 selectable working modes that optimise performance and fuel usage. The Economy mode can be adjusted for an ideal balance between power and economy to match your work. The oil flow delivered to hydraulic attachments is adjustable directly on the class-leading wide screen monitor panel.

Built-in versatility

To allow the use of many attachments, such as buckets, breakers or demolition tools, a power supply for a hydraulic quick coupler with adjustable pressure settings, and an additional hydraulic circuit controlled by a foot pedal and a sliding joystick push button are standard on the PC130-8. A second optional auxiliary line is also available for attachments that require extra hydraulic actuation.

A wide choice of options

With a choice of different styles of boom and arm, you can configure the PC130-8 to match specific demands for transport, working envelope or duty. The excavator can for instance be equipped with Komatsu's own Super Long Front end equipment, to let the machine work in otherwise inaccessible areas. Extra hydraulic arrangements are available for every boom and arm configuration, making sure that the machine always contributes strongly to your business.





Powerful and Environmentally Friendly

Low consumption ecot3 engine

The Komatsu SAA4D95LE-5 engine provides high torque, a better performance at low speed and low fuel consumption. This ecot3 engine features a new combustion chamber design with optimised ignition and combustion timing. The operating pressure of the new common rail system was increased for improved injection and fuel efficiency. The air-to-air charge cooler reduces the temperature of the compressed air supplied by the turbo charger to the cylinders, and further improves fuel consumption.

Meets EU Stage IIIA

The new Komatsu ecot3 engine technology reduces NOx and particle emissions, fuel consumption and noise level. The Komatsu SAA4D95LE-5 engine is certified for EPA Tier III and EU Stage IIIA emission regulations. To further reduce the machine's emissions, a Diesel Particulate Filter is also available.

Komatsu integrated hydraulic system

The PC130-8 is a highly responsive and productive machine with all major hydraulic parts designed and manufactured by Komatsu. The electronic Closed Load Sensing hydraulic System (CLSS) offers complete control during individual or combined movements - without sacrificing performance or productivity.

Eco-gauge and idle caution

The unique ECO-gauge helps the operator reduce emissions and fuel consumption for environmentally friendly and energy saving operations. And to further avoid wasting fuel when the machine is not actually working, a standard-fit idle caution is displayed if the engine idles for 5 minutes or more.

Komatsu SAA4D95LE-5



Eco-gauge



Idle caution





Exceptional drawbar pull and steering force

Regardless of the selected travel speed, the final drives automatically compensate for the load and give maximum driving force whenever needed. As a result, the PC130-8 generates exceptional drawbar pull and steering force, giving smooth, confident and safe machine movement.



First-Class Operator Comfort

Wide spacious cab

The newly designed, wide and spacious cab includes a heated air suspension seat with a reclining backrest. The seat height and longitudinal inclination are easily adjusted with a pull-up lever. You can also set the operational posture of the armrest and the position of the console or recline the seat all the way and place it into a fully flat state with the headrest attached.

Pressurised cab

An automatic air conditioner, an air filter and a positive internal air pressure (60 Pa) combine to prevent external dust from entering the cab.

Low noise design

Komatsu Dash 8 crawler excavators feature the lowest in-class external noise levels and are especially well-suited for work in confined spaces or urban areas. Reduced fan speed, a large capacity radiator, and the optimal usage of sound insulation and of sound absorbing materials help to make noise levels inside Dash 8 excavators comparable to those inside an executive car.

Cab damper mounting

The built-in stability of the Komatsu PC130-8, combined with a highly rigid deck and a sprung multi-layer viscous mount system, drastically reduces vibration levels for the operator.



Automatic air conditioner



Hot and cool box



Joysticks with proportional control button for attachments





Large, widescreen TFT monitor

To enable safe, accurate and smooth work, the user friendly monitor is the highly intuitive user interface for the machine's Equipment Management and Monitoring System (EMMS). Multilingual and with all essential information available at a glance, it features simple and easy to operate switches and multifunction keys that provide the operator with fingertip access to a wide range of functions and operating information.





Highest Safety Standards

Safe SpaceCab™

Specifically designed for Komatsu excavators, the Dash 8 cab has a tubular steel frame. It provides very high shock absorbency, impact resistance and durability. The seat belt is designed to keep the operator in the safety zone of the cab in the event of a roll-over. At your request, the Komatsu PC130-8 can also be fitted with an ISO 10262 Level 2 Falling Object Protective System (FOPS).

Safe and easy maintenance

Thermal guards are placed around high temperature parts of the engine. The fan belt and pulleys are well protected and in case of damage, fire risk is reduced by a pump/engine partition that prevents hydraulic oil from spraying onto the engine.

Optimal job site safety

Safety features on the Komatsu PC130-8 comply with the latest industry standards and work together as a system to minimise risks to personnel in and around the machine. An audible travel alarm further promotes job site safety. Very durable anti-slip plates – with additional high friction covering – maintain long term traction performance.

Rear view camera

A standard fitment camera gives an exceptionally clear view of the rear work zone on the wide-screen monitor panel. Large mirrors on both sides ensure that machine visibility meets the latest ISO standards.



Rear view camera

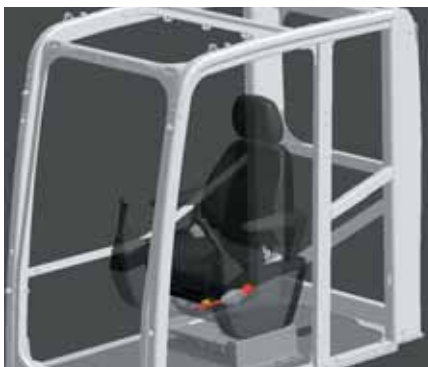

Safe SpaceCab™



Anti-slip plates





Quality You Can Rely On

Reliable and efficient

Productivity is the key to success – all major components of the PC130-8 are designed and directly manufactured by Komatsu. Essential machine functions are perfectly matched for a highly reliable and productive machine.

Rugged design

Maximum toughness and durability – along with top class customer service – are the cornerstones of Komatsu's philosophy. Single piece plates and castings are used in key areas of the machine's structure for good load distribution.

Komatsu-quality components

With the latest computer design techniques and a thorough test programme, Komatsu's global know-how produces machines that are designed, manufactured and tested to meet your highest standards.

Extensive dealer support network

The extensive Komatsu distribution and dealer network is standing by to help keep your fleet in optimum condition. Customised servicing packages are available, with express availability of spare parts, to make sure that your Komatsu will continue to perform at its peak.



Cast boom foot



Single piece boom plates



Komatsu Satellite Monitoring System



KOMTRAX™ is a revolutionary machine tracking system designed to save you time and money. You can now monitor your equipment anytime and anywhere. Use valuable machine data received via the KOMTRAX™ web site to optimise your maintenance planning and machine performances.

KOMTRAX™ can assist you with:

Full machine monitoring

Get detailed operation data to know when your machines are used and how productive they are.

Total Fleet Management

Keep track of the location of your machines at all times and discourage unapproved usage or theft.

Complete machine status

Receive warnings, alerts and cautions, via a web site or by e-mail, to help with maintenance planning and for longer machine life.

For further details on KOMTRAX™, please ask your Komatsu dealer for the latest KOMTRAX™ brochure.





Machine working time - With the "daily working record" chart, get precise engine running time data: when your machine was started and when it was shut down, as well as total engine running time.



Maintenance planning - To increase productivity and improve maintenance planning, alerts indicate when items such as filters or oil must be replaced.



Fleet location - The machine list instantly locates all your machines, even those in other countries.



Machine tracking during transport - When your machine is transported, KOMTRAX™ sends travel messages to the web site or by e-mail to inform you of its progress, and confirms when it reaches its destination.



Alarm notifications - You can receive notification of alarms both via the KOMTRAX™ website and by e-mail.



Added security - The "engine lock" feature allows to program when a machine's engine can be started. And with "geo-fence", KOMTRAX™ sends notification every time your machine moves in or out of a predetermined operating area.



Easy Maintenance

Side-by-side cooling

Since the radiator, aftercooler and oil cooler are arranged in parallel, it is easy to clean, remove and install them.



Easy access to the engine oil filter and fuel drain valve

The engine oil filter and fuel drain valve are mounted remotely to improve accessibility.



Auto shut-off refuel pump

The auto shut-off refuel pump prevents fuel spills onto hot or electrical areas, and prevents wasting fuel.



Water separator

This is standard equipment which removes any water that has become mixed with the fuel, preventing fuel system damage.



Washable floor

The floor is easy to keep clean. The gently inclined surface has a flanged floormat and drainage holes to facilitate runoff.

Inclined track frame

The track frame is sloped so that dirt will not accumulate and can be removed easily.

Long-life oil filters

The hydraulic oil filter uses high-performance filtering material for long element replacement intervals, which significantly reduces maintenance costs.



Flexible warranty

When you purchase Komatsu equipment, you gain access to a broad range of programmes and services that have been designed to help you get the most from your investment. For example, Komatsu's Flexible Warranty Programme provides a range of extended warranty options on the machine and its components. These can be chosen to meet your individual needs and activities. This programme is designed to help reduce total operating costs.

ENGINE

Model	Komatsu SAA4D95LE-5
Type	Common rail direct injection, water-cooled, emissionised, turbocharged, after-cooled diesel
Engine power	
at rated engine speed	2.200 rpm
ISO 14396	72,0 kW / 96,6 HP
ISO 9249 (net engine power)	68,4 kW / 91,7 HP
No. of cylinders	4
Bore x stroke	95 x 115 mm
Displacement	3,26 ltr
Battery	2 x 12 V/92 Ah
Alternator	24 V/60 A
Starter motor	24 V/4,5 kW
Air filter type	Double element type with monitor panel dust indicator and auto dust evacuator
Cooling	Suction type cooling fan with radiator fly screen

HYDRAULIC SYSTEM

Type	HydrauMind. Closed-centre system with load sensing and pressure compensation valves
Additional circuits	1 additional circuit with proportional control standard, a second additional circuit with proportional control may be fitted optionally
Main pump	Variable displacement piston pump supplying boom, arm, bucket, swing and travel circuits
Maximum pump flow	242 ltr/min
Relief valve settings	
Implement	352 bar
Travel	352 bar
Swing	276 bar
Pilot circuit	33 bar

UNDERCARRIAGE

Construction	X-frame centre section with box section track-frames
Track assembly	
Type	Fully sealed
Shoes (each side)	43
Tension	Combined spring and hydraulic unit
Rollers	
Track rollers (each side)	7
Carrier rollers (each side)	1

OPERATING WEIGHT (APPR.)

	MONO BOOM		TWO-PIECE BOOM	
	Operating weight	Ground pressure	Operating weight	Ground pressure
Triple grouser shoes				
500 mm	12.800 kg	0,41 kg/cm ²	13.125 kg	0,42 kg/cm ²
600 mm	12.980 kg	0,34 kg/cm ²	13.305 kg	0,35 kg/cm ²
700 mm	13.160 kg	0,30 kg/cm ²	13.485 kg	0,31 kg/cm ²

Operating weight, including specified work equipment, 2.500 mm arm, 0,5 m³ bucket, operator, lubricant, coolant, full fuel tank and the standard equipment.

Additional weight with 500 mm road-liner: + 130 kg
Additional weight with blade: + 900 kg

SWING SYSTEM

Type	Axial piston motor driving through planetary double reduction gearbox
Swing lock	Electrically actuated wet multi-disc brake integrated into swing motor
Swing speed	0 - 11 rpm
Swing torque	32,9 kNm

DRIVES AND BRAKES

Steering control	2 levers with pedals giving full independent control of each track
Drive method	Hydrostatic
Travel operation	Automatic 2-speed selection
Gradeability	70%, 35°
Max. travel speeds	
Lo / Hi	2,9 / 5,5 km/h
Maximum drawbar pull	12.500 kgf
Brake system	Hydraulically operated discs in each travel motor

SERVICE REFILL CAPACITIES

Fuel tank	247 ltr
Radiator	13,9 ltr
Engine oil	11 ltr
Swing drive	2,5 ltr
Hydraulic tank	90 ltr
Final drive (each side)	2,5 ltr

ENVIRONMENT

Engine emissions	Fully complies with EU Stage IIIA and EPA Tier III exhaust emission regulations
Noise levels	
LwA external	100 dB(A) (2000/14/EC Stage II)
LpA operator ear	68 dB(A) (ISO 6396 dynamic test)
Vibration levels (EN 12096:1997)*	
Hand/arm	≤ 2,5 m/s ² (uncertainty K = 0,90 m/s ²)
Body	≤ 0,5 m/s ² (uncertainty K = 0,13 m/s ²)

* for the purpose of risk assessment under directive 2002/44/EC, please refer to ISO/TR 25398:2006.

Dimensions & Performance Figures

MACHINE DIMENSIONS	PC130-8
A Overall width of upper structure	2.500 mm
B Overall height of cab	2.855 mm
C Overall length of basic machine	3.925 mm
D Tail length	2.110 mm
Tail swing radius	2.190 mm
E Clearance under counterweight	895 mm
F Machine tail height	2.190 mm
G Ground clearance	400 mm
H Tumbler center distance	2.880 mm
I Track length	3.610 mm
J Track gauge	1.990 mm
K Track shoe width	500; 600; 700 mm
L Overall track width with 500 mm shoe	2.490 mm
Overall track width with 600 mm shoe	2.590 mm
Overall track width with 700 mm shoe	2.690 mm

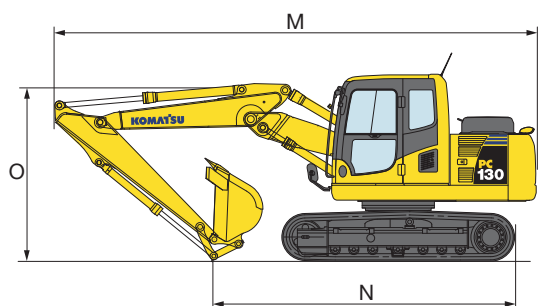
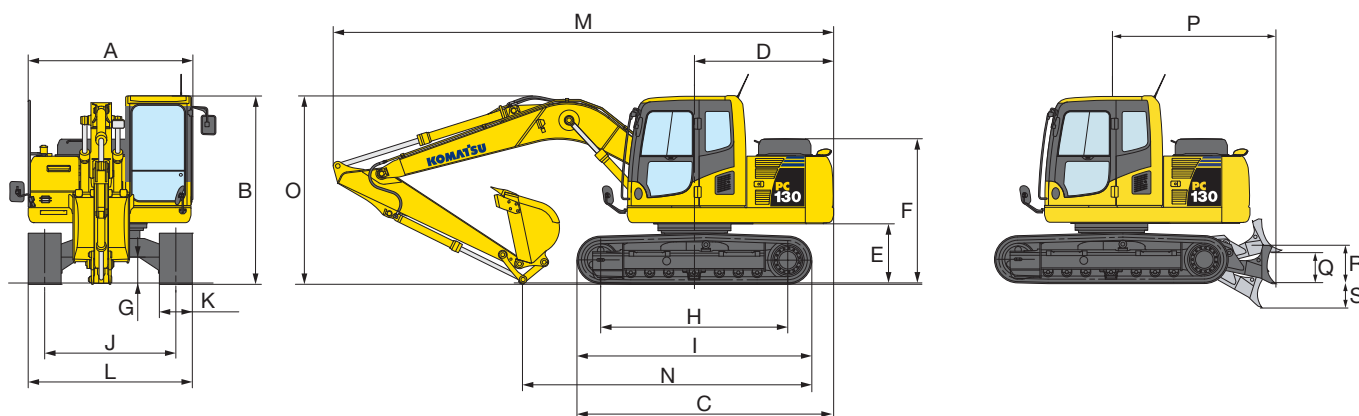

BLADE

P Distance, swing center to blade	2.490 mm
Q Height of blade	590 mm
R Blade, max. lifting height	470 mm
S Blade, max. digging depth	525 mm
Blade width	2.590 mm

TRANSPORT DIMENSIONS	MONO BOOM			TWO-PIECE BOOM		
Arm length	2.100 mm	2.500 mm	3.000 mm	2.100 mm	2.500 mm	3.000 mm
M Transport length	7.600 mm	7.590 mm	7.485 mm	7.425 mm	7.360 mm	7.220 mm
N Length on ground (transport)	4.670 mm	4.410 mm	4.280 mm	4.800 mm	4.610 mm	4.270 mm
O Overall height (to top of boom)	2.600 mm	2.875 mm	3.185 mm	2.545 mm	2.710 mm	3.095 mm

BUCKET OPTIONS & DIGGING FORCES

MAX. BUCKET CAPACITY AND WEIGHT

Arm length	MONO BOOM					
	2,1 m		2,5 m		3,0 m	
Material weight up to 1,2 t/m ³	0,8 m ³	620 kg	0,72 m ³	560 kg	0,72 m ³	560 kg
Material weight up to 1,5 t/m ³	0,72 m ³	560 kg	0,64 m ³	505 kg	0,64 m ³	505 kg
Material weight up to 1,8 t/m ³	0,64 m ³	505 kg	0,56 m ³	475 kg	0,48 m ³	470 kg

Arm length	TWO-PIECE BOOM					
	2,1 m		2,5 m		3,0 m	
Material weight up to 1,2 t/m ³	0,8 m ³	620 kg	0,72 m ³	560 kg	0,72 m ³	560 kg
Material weight up to 1,5 t/m ³	0,72 m ³	560 kg	0,64 m ³	505 kg	0,64 m ³	505 kg
Material weight up to 1,8 t/m ³	0,64 m ³	505 kg	0,56 m ³	475 kg	0,48 m ³	470 kg

Max capacity and weight have been calculated according to ISO 10567:2007.

Please consult with your distributor for the correct selection of buckets and attachments to suit the application.

A full range of Komatsu wear parts is available.

A wide range of attachments is available. Please consult your distributor for details of the full range.



BUCKET AND ARM FORCE

Arm length	2.100 mm	2.500 mm	3.000 mm
Bucket digging force	8.800 kgf	8.800 kgf	8.800 kgf
Bucket digging force at PowerMax	9.500 kgf	9.500 kgf	9.500 kgf
Arm crowd force	7.200 kgf	6.300 kgf	5.700 kgf
Arm crowd force at PowerMax	7.900 kgf	6.900 kgf	6.200 kgf

Working Range

MONO BOOM

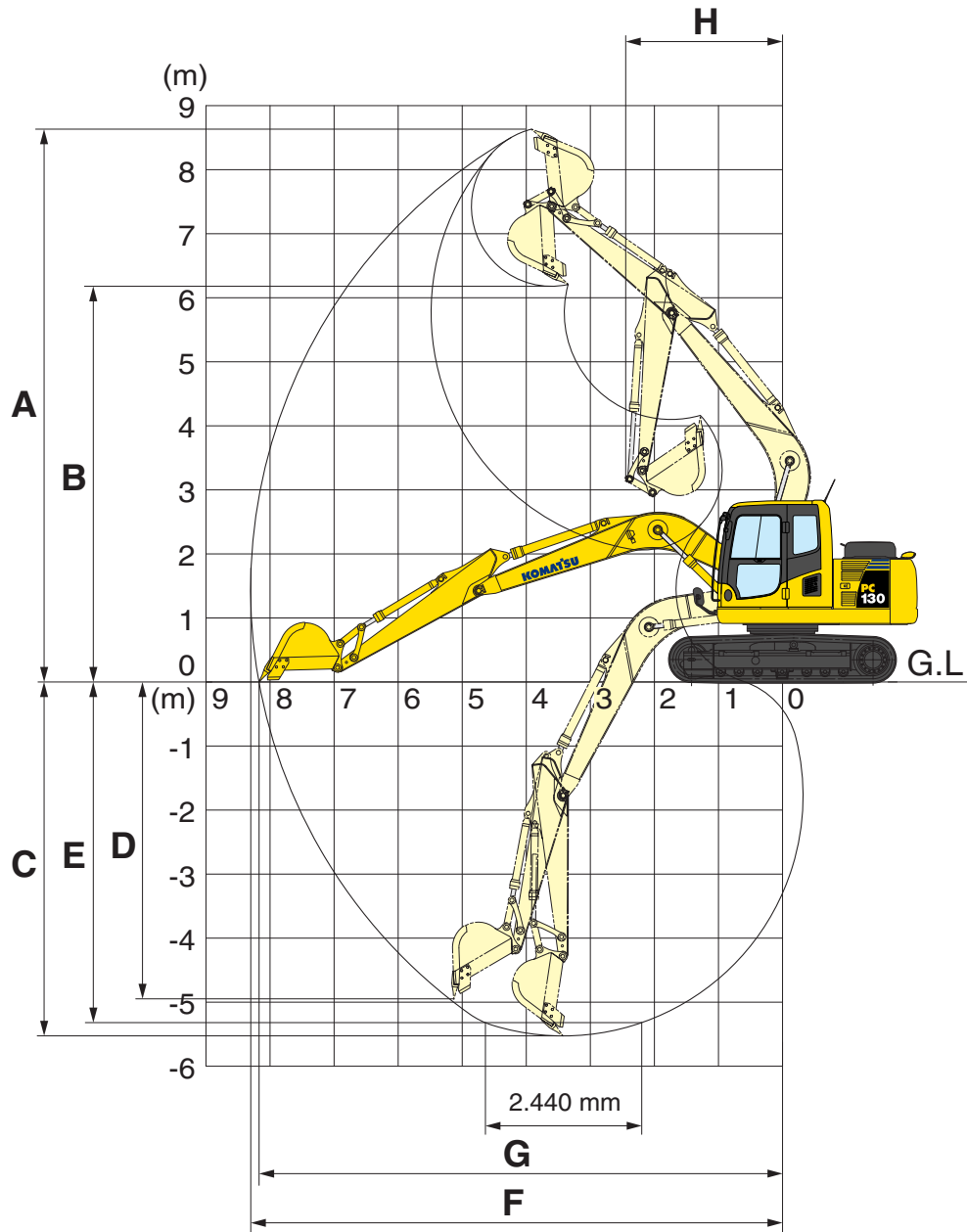

ARM LENGTH	2.100 mm	2.500 mm	3.000 mm
A Max. digging height	8.390 mm	8.650 mm	8.930 mm
B Max. dumping height	5.935 mm	6.210 mm	6.615 mm
C Max. digging depth	5.125 mm	5.520 mm	5.955 mm
D Max. vertical wall digging depth	4.570 mm	4.980 mm	5.365 mm
E Max. digging depth of cut for 2,44 m level	4.870 mm	5.320 mm	5.775 mm
F Max. digging reach	7.930 mm	8.290 mm	8.720 mm
G Max. digging reach at ground level	7.795 mm	8.170 mm	8.595 mm
H Min. swing radius	2.410 mm	2.450 mm	2.610 mm



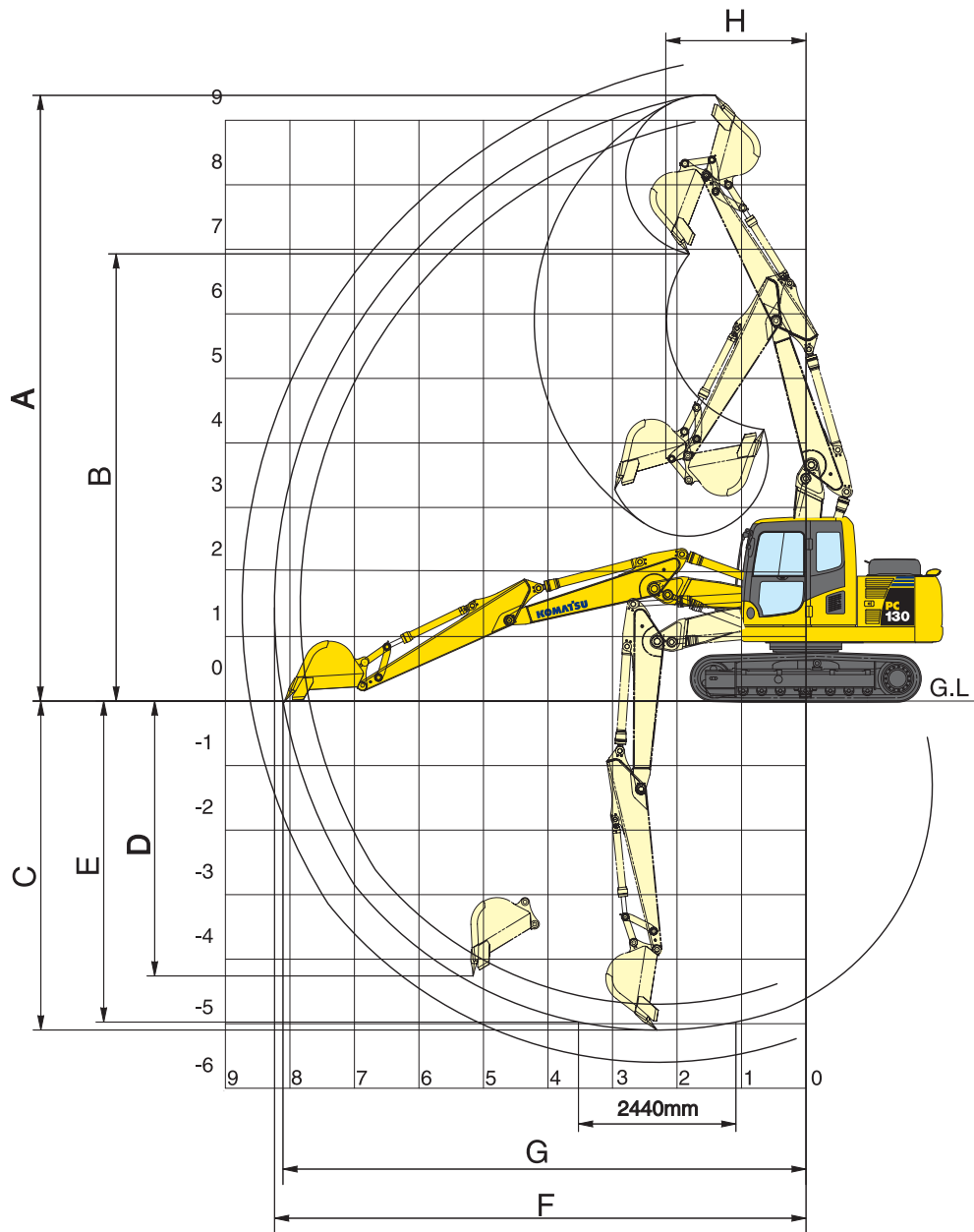















TWO-PIECE BOOM

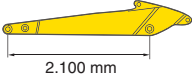

ARM LENGTH	2.100 mm	2.500 mm	3.000 mm
A Max. digging height	9.120 mm	9.490 mm	9.955 mm
B Max. dumping height	6.670 mm	7.045 mm	7.510 mm
C Max. digging depth	4.705 mm	5.105 mm	5.605 mm
D Max. vertical wall digging depth	3.920 mm	4.260 mm	4.770 mm
E Max. digging depth of cut for 2,44 m level	4.535 mm	5.000 mm	5.505 mm
F Max. digging reach	7.895 mm	8.285 mm	8.775 mm
G Max. digging reach at ground level	7.755 mm	8.155 mm	8.650 mm
H Min. swing radius	1.955 mm	2.150 mm	2.500 mm

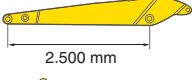
Lifting Capacity

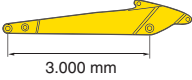
MONO BOOM

Arm length	A		⊗		7,5 m		6,0 m		4,5 m		3,0 m		1,5 m	
	B													
With 700 mm shoe  2.100 mm  469 kg	6,0 m	kg	*2.400	*2.400					*3.400	*3.400				
	4,5 m	kg	*2.250	2.000			2.950	2.200	*3.550	*3.550				
	3,0 m	kg	*2.250	1.700			2.950	2.150	*4.350	3.450	*6.000	*6.000		
	1,5 m	kg	2.200	1.550			2.850	2.050	4.550	3.250	*8.550	6.000		
	0,0 m	kg	2.250	1.600			2.750	2.000	4.250	3.050	*7.400	5.650		
	-1,5 m	kg	2.550	1.800			2.750	1.950	4.150	3.000	8.750	5.600	*4.750	*4.750
	-3,0 m	kg	3.300	2.350					4.300	3.000	*7.550	5.750	*8.800	*8.800
-4,5 m	kg													
With 700 mm shoe  2.500 mm  469 kg	6,0 m	kg	*1.950	*1.950										
	4,5 m	kg	*1.800	1.700			3.000	2.250	*3.150	*3.150				
	3,0 m	kg	*1.850	1.550	2.250	1.650	2.950	2.200	*3.950	3.550	*5.200	*5.200		
	1,5 m	kg	*1.950	1.450	2.200	1.600	2.850	2.100	4.550	3.300	*7.900	6.150		
	0,0 m	kg	2.050	1.450	2.150	1.550	2.750	2.000	4.250	3.000	*8.050	5.700		
	-1,5 m	kg	2.250	1.600			2.700	1.950	4.250	3.000	8.700	5.600	*4.700	*4.700
	-3,0 m	kg	2.850	2.050					4.250	2.950	*8.050	5.700	*7.850	*7.850
-4,5 m	kg	*3.600	3.200							*5.450	*5.450			
With 700 mm shoe  3.000 mm  469 kg	6,0 m	kg	*1.550	*1.550			*2.200	2.250						
	4,5 m	kg	*1.450	1.450	*1.950	1.650	*2.750	2.250						
	3,0 m	kg	*1.450	1.350	2.200	1.650	2.950	2.200	*3.450	*3.450				
	1,5 m	kg	*1.550	1.250	2.150	1.550	2.800	2.050	*4.550	3.300	*6.800	6.250		
	0,0 m	kg	*1.750	1.250	2.100	1.500	2.700	1.950	4.300	3.050	8.800	5.650		
	-1,5 m	kg	1.950	1.350	2.050	1.450	2.650	1.850	4.050	2.900	8.550	5.450	*4.100	*4.100
	-3,0 m	kg	2.350	1.650			2.600	1.850	4.050	2.900	*8.450	5.500	*6.650	*6.650
-4,5 m	kg	*3.400	2.450					*4.200	3.000	*6.500	5.650	*10.350	*10.350	

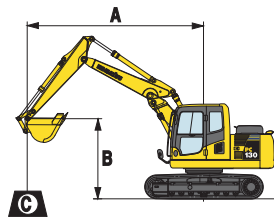
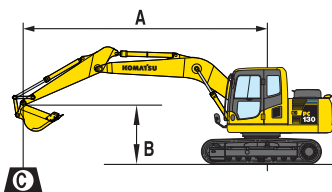

A – Reach from swing center

B – Bucket hook height

C – Lifting capacities, including bucket (469 kg), bucket linkage (120 kg) and bucket cylinder (83 kg)

 – Rating over front

 – Rating over side

 – Rating at maximum reach

When removing bucket, linkage or cylinder, lifting capacities can be increased by their respective weights.















With 600 mm shoes



* Load is limited by hydraulic capacity rather than tipping.

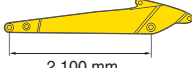

Ratings are based on SAE Standard No. J1097.















Rated loads do not exceed 87% of hydraulic lift capacity or 75% of tipping load.



TWO-PIECE BOOM



Arm length	A		7,5 m		6,0 m		4,5 m		3,0 m		1,5 m		
	B												
With 700 mm shoe  2.100 mm  469 kg	7,5 m	kg	*3.650	*3.650						*3.850	*3.850		
	6,0 m	kg	*2.600	*2.600				*4.200	3.550	*4.600	*4.600		
	4,5 m	kg	*2.350	2.000			3.050	2.100	*4.800	3.500	*4.150	*4.150	
	3,0 m	kg	*2.350	1.650			3.000	2.050	4.950	3.300	*7.900	6.550	
	1,5 m	kg	2.300	1.550			2.900	1.950	4.650	3.100			
	0,0 m	kg	2.400	1.550			2.800	1.850	4.450	2.900			
	-1,5 m	kg	*2.600	1.750			2.800	1.850	4.400	2.850	*6.550	5.400	
	-3,0 m	kg											
	-4,5 m	kg											

With 700 mm shoe  2.500 mm  469 kg	7,5 m	kg	*2.750	*2.750						*4.200	*4.200		
	6,0 m	kg	*2.150	*2.150				*3.850	3.650				
	4,5 m	kg	*1.950	1.800			3.150	2.150	*3.950	3.600	*3.300	*3.300	
	3,0 m	kg	*1.900	1.550			3.100	2.100	*5.000	3.400	*6.000	*6.000	
	1,5 m	kg	*2.000	1.450			2.950	2.000	4.750	3.150			
	0,0 m	kg	2.200	1.450			2.850	1.900	4.550	2.950	*6.550	5.500	
	-1,5 m	kg	2.450	1.600			2.800	1.850	4.400	2.850	*7.400	5.400	
	-3,0 m	kg							*3.400	2.900			
	-4,5 m	kg											

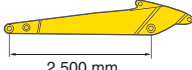
With 700 mm shoe  3.000 mm  469 kg	7,5 m	kg	*2.200	*2.200				*2.750	*2.750					
	6,0 m	kg	*1.800	*1.800			*2.450	2.250	*3.300	*3.300				
	4,5 m	kg	*1.650	1.600			3.250	2.250	*3.150	*3.150				
	3,0 m	kg	*1.600	1.400	*2.050	1.450	3.150	2.200	*3.750	3.550	*3.100	*3.100		
	1,5 m	kg	*1.700	1.300	2.100	1.400	3.050	2.050	4.900	3.300	*8.650	6.250		
	0,0 m	kg	*1.850	1.300	2.050	1.350	2.900	1.950	4.600	3.050	*7.900	5.650		
	-1,5 m	kg	*2.150	1.450			2.850	1.900	4.450	2.900	*8.250	5.450	*3.100	*3.100
	-3,0 m	kg					*2.400	1.900	*4.150	2.900	*5.900	5.450		
	-4,5 m	kg												

Arm length	A		7,5 m		6,0 m		4,5 m		3,0 m		1,5 m		
	B												
With 500 mm shoe  2.100 mm  469 kg	7,5 m	kg	*3.650	*3.650						*3.850	*3.850		
	6,0 m	kg	*2.600	*2.600				*4.200	3.450	*4.600	*4.600		
	4,5 m	kg	*2.350	1.950			2.950	2.000	*4.800	3.450	*4.150	*4.150	
	3,0 m	kg	*2.350	1.600			2.950	2.000	4.800	3.250	*7.900	6.400	
	1,5 m	kg	2.250	1.500			2.800	1.900	4.550	3.000			
	0,0 m	kg	2.300	1.500			2.750	1.800	4.350	2.800			
	-1,5 m	kg	*2.600	1.700			2.700	1.800	4.250	2.750	*6.550	5.250	
	-3,0 m	kg											
		kg											

With 500 mm shoe  2.500 mm  469 kg	7,5 m	kg	*2.750	*2.750						*4.200	*4.200		
	6,0 m	kg	*2.150	*2.150				*3.850	3.550				
	4,5 m	kg	*1.950	1.750			3.050	2.100	*3.950	3.550	*3.300	*3.300	
	3,0 m	kg	*1.900	1.500			3.000	2.050	4.900	3.350	*6.000	*6.000	
	1,5 m	kg	*2.000	1.400			2.900	1.950	4.650	3.100			
	0,0 m	kg	2.150	1.400			2.750	1.850	4.400	2.900	*6.550	5.400	
	-1,5 m	kg	2.350	1.550			2.750	1.800	4.300	2.800	*7.400	5.250	
	-3,0 m	kg							*3.400	2.800			
		kg											

With 500 mm shoe  3.000 mm  469 kg	7,5 m	kg	*2.200	*2.200				*2.750	*2.750					
	6,0 m	kg	*1.800	*1.800			*2.450	2.200	*3.300	*3.300				
	4,5 m	kg	*1.650	1.550			3.150	2.200	*3.150	*3.150				
	3,0 m	kg	*1.600	1.350	2.050	1.400	3.100	2.100	*3.750	3.450	*3.100	*3.100		
	1,5 m	kg	*1.700	1.250	2.000	1.350	2.950	2.000	4.750	3.200	*8.650	6.100		
	0,0 m	kg	*1.850	1.300	2.000	1.300	2.850	1.900	4.500	2.950	*7.900	5.500		
	-1,5 m	kg	2.100	1.400			2.750	1.850	4.350	2.800	*8.250	5.300	*3.100	*3.100
	-3,0 m	kg					*2.400	1.850	*4.150	2.800	*5.900	5.300		
		kg												

Super Long Front Specification

Specifications PC130-8 Super Long Front

WORK EQUIPMENT

Boom	
Length (a)	7.115 mm
Height (b)	1.260 mm
Weight	900 kg
Arm	
Length (c)	5.795 mm
Height (d)	960 mm
Weight	530 kg

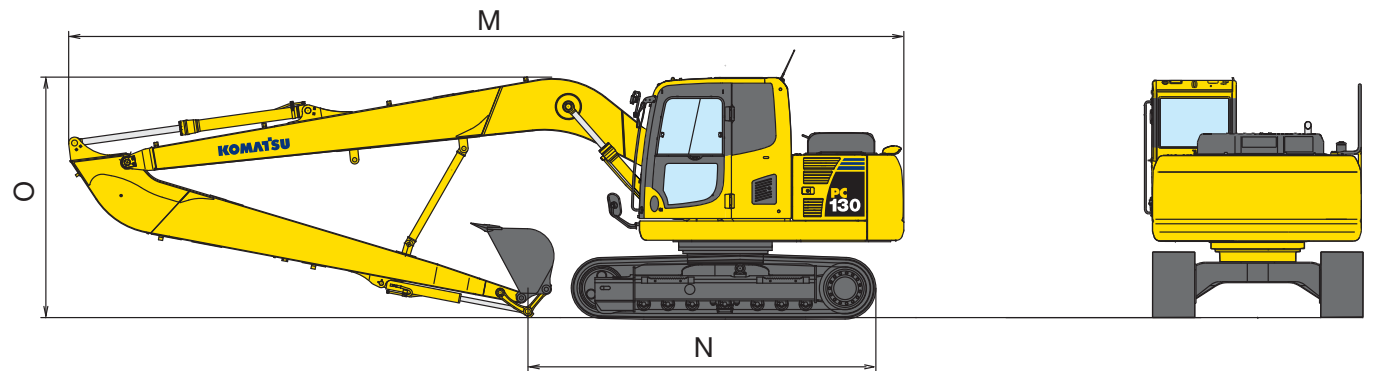
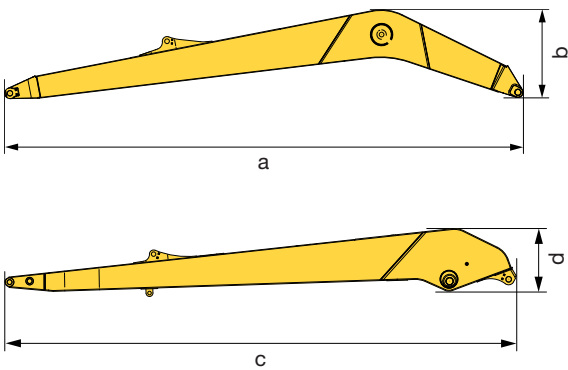

TRANSPORT DIMENSIONS

M	Transport length	9.990 mm
N	Length on ground (transport)	4.110 mm
O	Overall height (to top of boom)	2.770 mm

OPERATING WEIGHT (APPR.)

Triple grouser shoes	Operating weight	Ground pressure
500 mm	13.280 kg	0,41 kg/cm ²
600 mm	13.455 kg	0,36 kg/cm ²
700 mm	13.635 kg	0,32 kg/cm ²

Operating weight, including Super Long Front work equipment, bucket, operator, lubricant, coolant, full fuel tank and the standard equipment.

MAX. BUCKET CAPACITY AND WEIGHT

General purpose bucket		
Max. bucket width	750 mm	
Material weight up to 1,2 t/m ³	0,36 m ³	230 kg
Material weight up to 1,5 t/m ³	0,30 m ³	212 kg
Material weight up to 1,8 t/m ³	0,26 m ³	200 kg
Ditch cleaning bucket		
Max. bucket width	750 mm	
Material weight up to 1,2 t/m ³	* 660 kg	
Material weight up to 1,5 t/m ³	* 660 kg	
Material weight up to 1,8 t/m ³	-	

* Maximum load at end of arm (bucket + payload).

Max capacity and weight have been calculated according to ISO 10567:2007. Please consult with your distributor for the correct selection of buckets and attachments to suit the application.

Working range PC130-8 Super Long Front

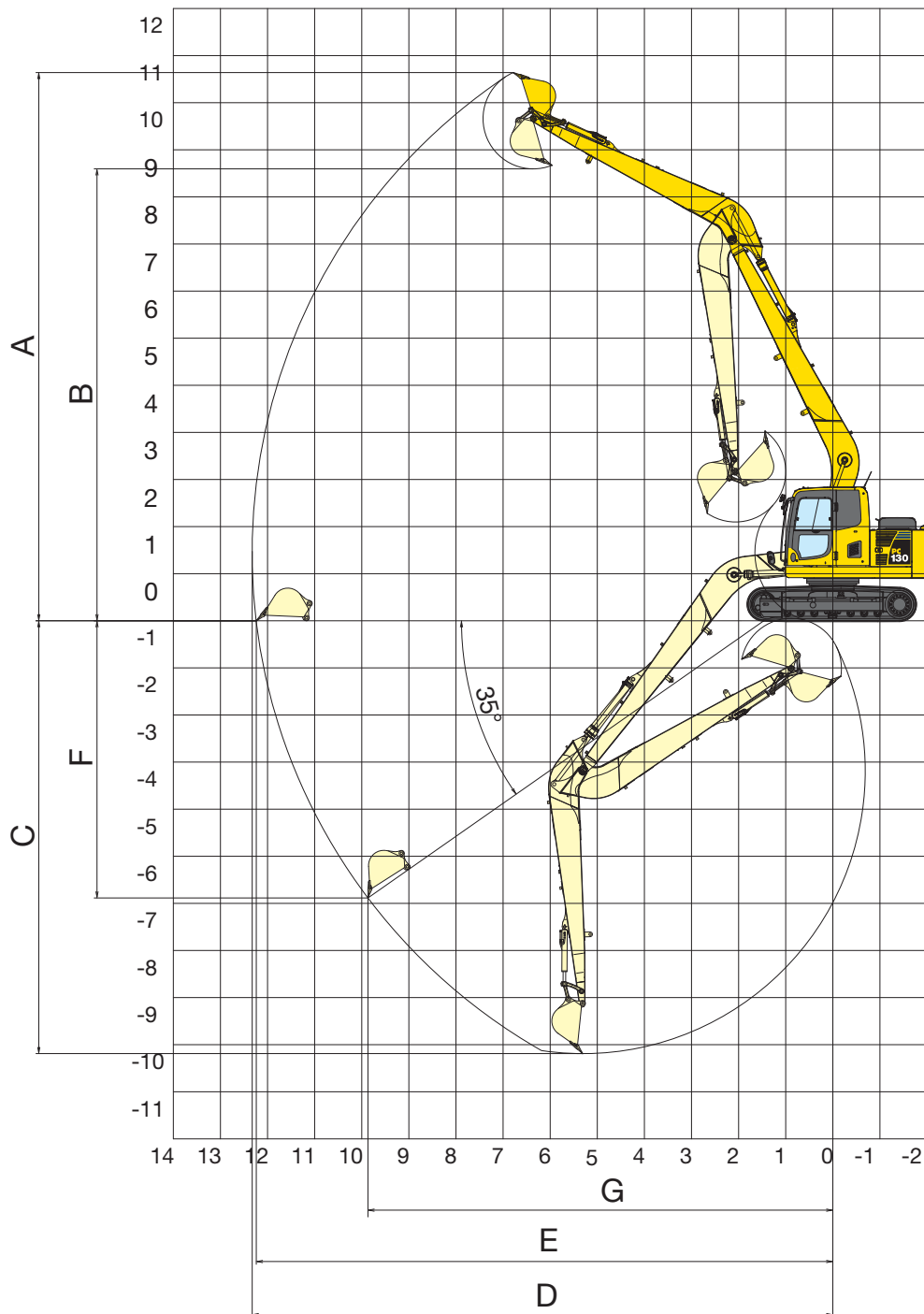

SUPER LONG FRONT

A	Max. digging height	11.640 mm
B	Max. dumping height	9.600 mm
C	Max. digging depth	9.190 mm
D	Max. digging reach	12.330 mm
E	Max. digging reach at ground level	12.240 mm
F	Max. digging depth on 35° slope	5.880 mm
G	Max. digging reach on 35° slope	9.870 mm

Super Long Front Specification

Lifting capacity PC130-8 Super Long Front

A – Reach from swing center

B – Bucket hook height

C – Lifting capacities, including bucket (210 kg)

 – Rating over front







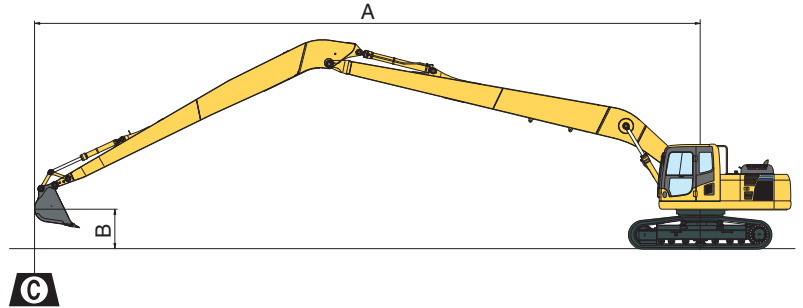





 – Rating over side

 – Rating at maximum reach

When removing bucket, linkage or cylinder, lifting capacities can be increased by their respective weights.



PC130-8 With 500 mm shoes

A			11,0 m		9,0 m		7,0 m		5,0 m		3,0 m	
												
9,0 m kg	*750	*750										
7,0 m kg	*700	*700			*1.400	1.050						
5,0 m kg	*700	600			1.500	1.000	*1.650	*1.650				
3,0 m kg	*750	500	950	550	1.400	900	*2.050	1.500	*2.600	*2.600	*4.100	*4.100
1,0 m kg	800	450	900	500	1.300	800	2.000	1.250	3.350	2.150	*3.500	*3.500
0,0 m kg	800	450	850	450	1.250	750	1.900	1.200	3.150	1.950	*2.900	*2.900
-1,0 m kg	800	450	850	450	1.200	700	1.800	1.100	3.000	1.800	*3.050	*3.050
-2,0 m kg	850	450			1.150	650	1.750	1.050	2.900	1.700	*3.400	*3.400
-3,0 m kg	900	500			1.150	650	1.700	1.000	2.800	1.650	*3.900	3.750
-4,0 m kg	950	550			1.150	650	1.650	950	2.800	1.650	*4.500	3.800
-5,0 m kg	1.050	600			1.150	650	1.650	1.000	2.800	1.650	*5.200	3.900
-6,0 m kg	1.250	750					1.700	1.000	2.850	1.700	*6.000	4.000
-7,0 m kg	1.550	950					1.750	1.050	2.950	1.750	*5.400	4.150
-8,0 m kg	*2.150	1.350							*2.800	1.900		

* Load is limited by hydraulic capacity rather than tipping. Ratings are based on SAE Standard No. J1097. Rated loads do not exceed 87% of hydraulic lift capacity or 75% of tipping load. Lifting capacity table is published for guidance only, the machine is not intended for use as a crane.

Hydraulic Excavator

PC130-8

Standard and Optional Equipment

ENGINE

Komatsu SAA4D95LE-5 turbocharged common rail direct injection diesel engine	●
EU Stage IIIA/EPA Tier III compliant	●
Suction type cooling fan with radiator fly screen	●
Automatic engine warm-up system	●
Engine overheat prevention system	●
Fuel control dial	●
Auto-deceleration function	●
Engine key stop	●
Engine ignition can be password secured on request	●
Alternator 24 V/60 A	●
Starter motor 24 V/4,5 kW	●
Batteries 2 × 12 V/92 Ah	●
Diesel particulate filter	○

HYDRAULIC SYSTEM

Electronic closed-centre load sensing (E-CLSS) hydraulic system (HydrauMind)	●
Pump and engine mutual control (PEMC) system	●
5-working mode selection system; Power mode, economy mode, breaker mode, attachment mode and lifting mode	●
PowerMax function	●
Adjustable PPC wrist control levers for arm, boom, bucket and swing, with sliding proportional control for attachments and 3 auxiliary buttons	●
Prepared for hydraulic quick-coupler (not with Super Long Front)	●
One additional, 2-way proportional service valve (full flow) (not with Super Long Front)	●
Additional (low flow) hydraulic circuit with 2-way proportional control (not with Super Long Front)	○

UNDERCARRIAGE

Track frame under-guards	●
500 mm triple grouser track-shoes	●
600, 700 mm triple grouser track-shoes	○
500 mm road-liner track-shoes	○

CABIN

Reinforced safety SpaceCab™; Highly pressurised and tightly sealed hyper viscous mounted cab with tinted safety glass windows, large roof window with sun shade, pull-up type front window with locking device, removable lower window, front window wiper with intermittent feature, sun roller blind, cigarette lighter, ashtray, luggage shelf, floor mat	●
Heated air suspension seat with lumbar support, height adjustable arm rests and retractable seat belt	●
Automatic climate control system	●
12 Volt power supply	●
Beverage holder and magazine rack	●
Hot and cool box	●
Radio	●
Rain visor (not with OPG)	○

SERVICE AND MAINTENANCE

Automatic fuel line de-aeration	●
Double element type air cleaner with dust indicator and auto dust evacuator	●
KOMTRAX™ - Komatsu satellite monitoring system	●
Multi-function video compatible colour monitor with Equipment Management and Monitoring System (EMMS) and efficiency guidance	●
Toolkit and spare parts for first service	●

WORK EQUIPMENT

Mono boom	○
Two-piece boom	○
2,1 m; 2,5 m; 3,0 m arms	○
Super Long Front boom and arm (12,3 m)	○
Dozer blade	○
Komatsu buckets	○
Komatsu breakers (not with Super Long Front)	○

SAFETY EQUIPMENT

Rear view camera system	●
Electric horn	●
Overload warning device	●
Lockable fuel cap and covers	●
Audible travel alarm	●
Boom safety valves	●
Large handrails, rear-view mirrors	●
Battery main switch	●
Arm safety valve (not with Super Long Front)	●
OPG Level II front guard (FOPS)	○
OPG Level II top guard (FOPS)	○

DRIVES AND BRAKES

Hydrostatic, 2-speed travel system with automatic shift and planetary gear type final drives, and hydraulic lock service brakes	●
---	---

LIGHTING SYSTEM

Working lights: 2 revolving frame and 1 boom light	●
Additional working lights: 5 cab roof lights, 1 boom light (r.h.), 1 counterweight (rear), beacon	○

OTHER EQUIPMENT

Standard counterweight	●
Electric refuelling pump with automatic shut off function	●
Standard colour scheme and decals	●
Parts book and operator manual	●

Further equipment on request

- standard equipment
- optional equipment

Your Komatsu partner:

KOMATSU

**Komatsu Europe
International NV**
Mechelsesteenweg 586
B-1800 VILVOORDE (BELGIUM)
Tel. +32-2-255 24 11
Fax +32-2-252 19 81
www.komatsu.eu

UESS13604 08/2012

Materials and specifications are subject to change without notice.
KOMATSU is a trademark of Komatsu Ltd. Japan.