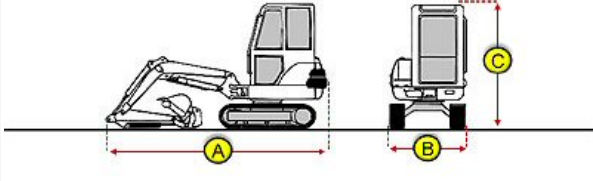

Inspection Report (Mini Excavator)

General Info

Year	2013
Make	Takeuchi
Model	TB016
Serial Number	116116151
Hour Meter Reading	1,754 Hours
Previous Application (e.g., earth moving, mining, demolition, etc)	Pipeline/Electrical Construction

Dimensions

Measurement Guide	
A. Length (ft and inches)	12'7"
B. Width (ft and inches)	3'3" with tracks retracted
C. Height (ft and inches)	7'6"
Operational Weight (lbs)	3,230 lbs.



Features and Configuration

Control Station Type	Canopy
Bucket	Yes
Bucket Size (in inches)	18
Blade	Yes
Additional Attachment(s)	No
Hydraulic Coupler	No
Auxiliary Hydraulics	Yes
Hydraulic Thumb	No
Heat	No
A/C	No
Radio	No
Backup Camera	No
OMM (Operator & Maintenance Manual)	Yes
Telematics	No

OMM Specifications

Inspection Report (Mini Excavator)

OMM Specifications

Detail Specifications	Take photos of the detailed spec pages included in the operator's manual
OMM Spec Photos	
	

Inspection Report (Mini Excavator)



Inspection Report (Mini Excavator)

Inspection Report (Mini Excavator)

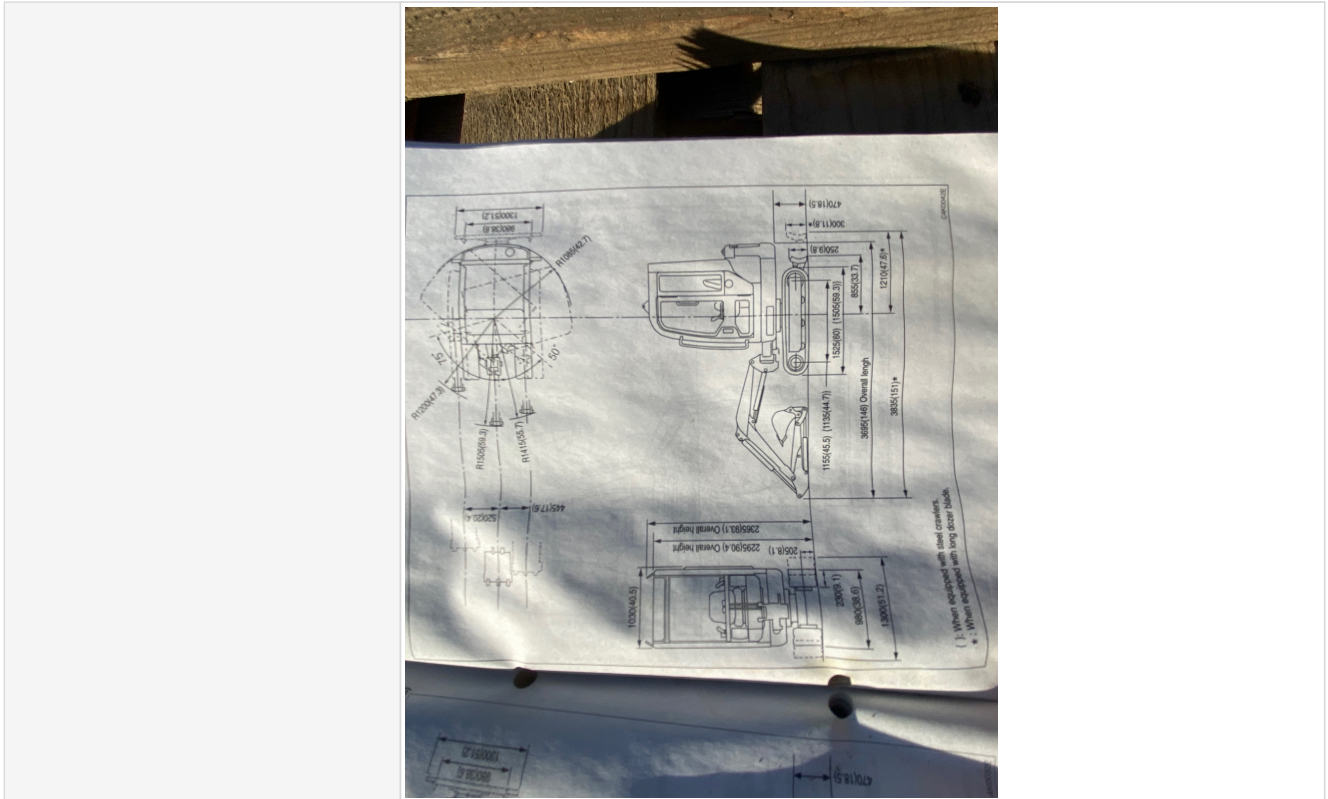

Exterior Walkaround Photos

Exterior 360 Walkaround

Instructions

Take photos of the exterior of the piece of equipment. Capture a full 360 degree walk around and all major components.

Must have shots to capture:

- Front
- 45 degree corner shot of left front
- 45 degree corner shot of right front
- Left side
- Right side
- Rear
- 45 degree corner shot of left rear
- 45 degree corner shot of right rear

Tips for good photos:

- Move the equipment into a open area without any visual distractions or other equipment in the background

Inspection Report (Mini Excavator)

Exterior Walkaround Photos



Inspection Report (Mini Excavator)



Inspection Report (Mini Excavator)

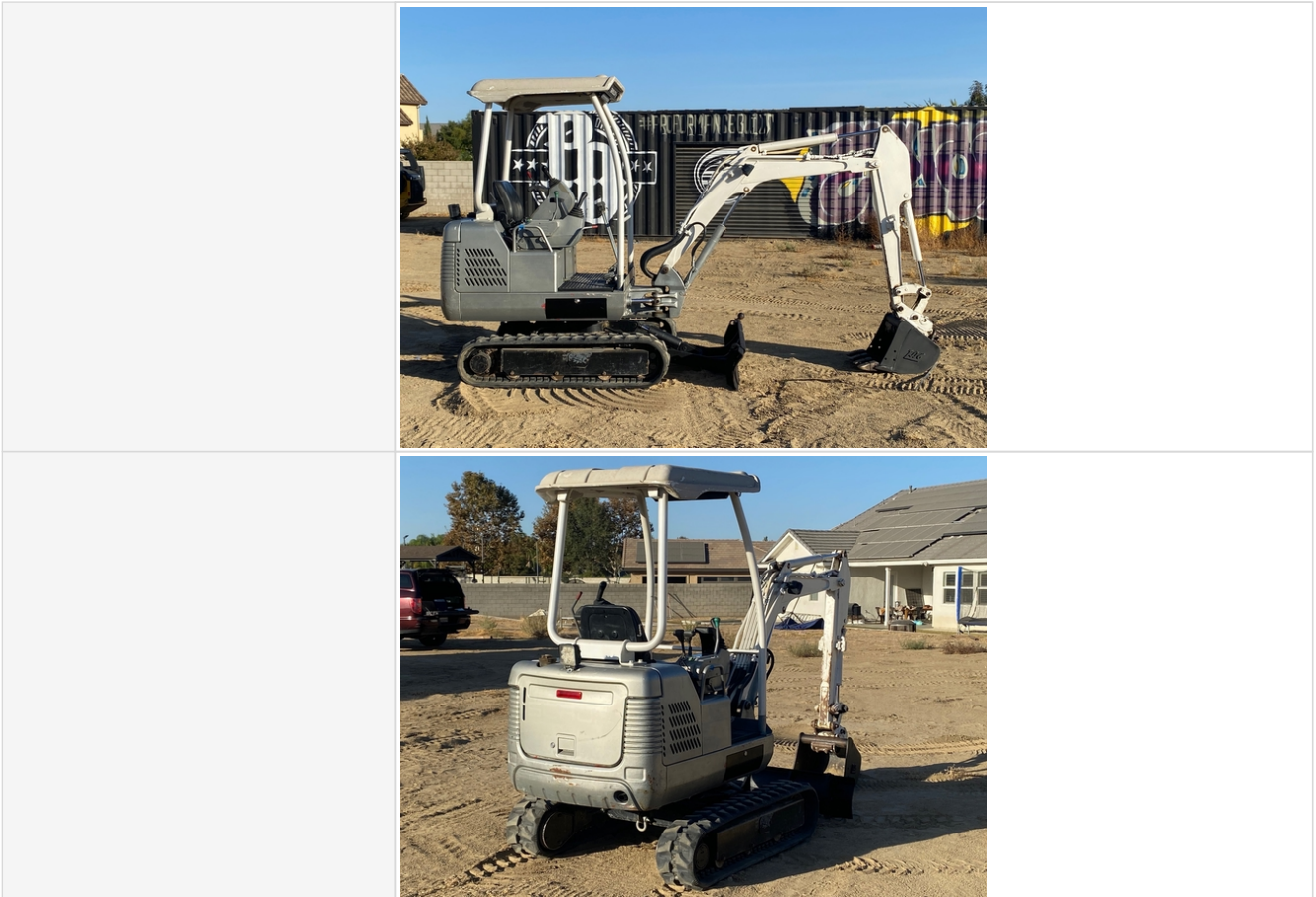



General Appearance Inspection Points

General Appearance



Front	3 - Normal Wear & Tear
Front Condition	Visible chipped paint or dents, Other (see comments)
Comments	Normal wear and tear





Inspection Report (Mini Excavator)

		
Rear	3 - Normal Wear & Tear	
Rear Condition	Visible chipped paint or dents, Other (see comments)	
Comments	Normal wear and tear	
Rear Photos		
		
Left	3 - Normal Wear & Tear	
Left Condition	No visible damage, Other (see comments)	



Inspection Report (Mini Excavator)

Left Photos	
	
Right	3 - Normal Wear & Tear
Right Condition	No visible damage, Visible chipped paint or dents
Right Photos	
Upper	3 - Normal Wear & Tear
Upper Condition	No visible damage, Visible chipped paint or dents

Inspection Report (Mini Excavator)

Upper Photos	
	
Body Panels (Any Rust Damage?)	3 - Normal Wear & Tear
Body Panel Condition	No visible damage, good paint condition and panel fitment, Other (see comments)
Comments	Normal wear and tear
Body Panels Photos	
Doors / Canopy Latches	3 - Normal Wear & Tear
Doors / Canopy Latches Condition	No visible damage
Steps / Ladders	0
Handrails	0

Inspection Report (Mini Excavator)



Glass Condition	0
Mirrors	0
Lighting System	3 - Normal Wear & Tear
Lighting System Condition	No visible damage, lighting system is operational
Lighting System Photos	
	
	

Inspection Report (Mini Excavator)



Control Station Inspection Points

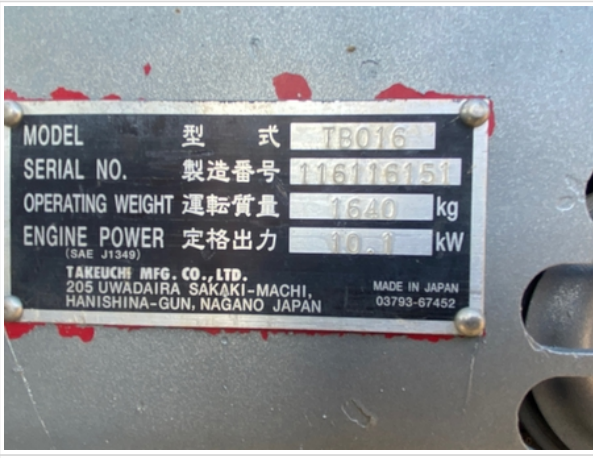

Control Station

Serial Number Plate Photo	
Operator Cabin Overall	3 - Normal Wear & Tear
Operator Cabin Overall Condition	Good cabin appearance, solid floors, panels, and ceiling
Operator Cabin Photos	



Inspection Report (Mini Excavator)





Inspection Report (Mini Excavator)

	
	
	
Operator's Seat & Arm Rests	3 - Normal Wear & Tear
Operator's Seat & Arm Rests Condition	Seat(s) in good condition, no stains or tears in upholstery, Seat(s) have minor surface staining or small tears

Inspection Report (Mini Excavator)

Operator's Seat & Arm Rests Photos	
Seat Belt	2 - Above Average Wear
Seat Belt Condition	Seat belt shows limited functionality or does not secure properly
Cabin Lights	0
Safety Lock Out / Stop	3 - Normal Wear & Tear
Safety Lock Out / Stop Condition	Safety lock out device is present, in good condition, and functional, Other (see comments)
Comments	Hydraulic lockout mechanism may need to be adjusted (gets stuck once set to on/left side console down position)
Safety Lock Out / Stop Photos	
Controls & Switches	3 - Normal Wear & Tear
Controls & Switches Condition	All switches are installed and functional
Controls & Switches Photos	
Hour Meter Activity	3 - Normal Wear & Tear
Hour Meter Condition	Hour meter is functional and in good condition



Inspection Report (Mini Excavator)

Hour Meter Activity Photos	
Other Gauge Activity	3 - Normal Wear & Tear
Other Gauge Condition	All cockpit gauges are functional and in good condition
Other Gauge Activity Photos	
Heater & A/C	0
Fans / Vents	0
Travel Alarm	2 - Above Average Wear
Travel Alarm Condition	System is configured but not operating correctly, Other (see comments)
Comments	Travel alarm disconnected
Horn	3 - Normal Wear & Tear
Backup Camera	0
Fire Extinguisher	0
First Aid Kit	0

Engine Inspection Points

Engine	
Engine Type (Make, Model, Cylinders, Hp)	Yanmar - 3TNV70-STB - 3 CYL. - 14HP
Emissions Tier	Other (see comments)
Comments	Under 75HP therefore after treatment system not required

Inspection Report (Mini Excavator)

Engine Serial Number	N/A
Engine Fuel Type	Diesel
Engine Photos	
	
	



Inspection Report (Mini Excavator)





Inspection Report (Mini Excavator)





Inspection Report (Mini Excavator)

	 <p>EMISSION CONTROL INFORMATION</p> <p>THIS ENGINE MEETS U.S. EPA AND CALIFORNIA EMISSION STANDARDS UNDER 40 CFR 1039.625 AND 13 CCR 24231(d) SELLING OR INSTALLING THIS ENGINE FOR ANY PURPOSE OTHER THAN FOR THE EQUIPMENT. REGULATORY PROVISIONS CITED MAY BE A VIOLATION OF FEDERAL AND CALIFORNIA LAW SUBJECT TO CIVIL PENALTY. USE ONLY LOW SULFUR FUEL ONLY.</p> <p>ENGINE FAMILY : CYDXLO-85V3N (B5AWK19) DISP. : 0.854 L</p> <p>MODEL : 3TNV70-S E.C.S. : EM1F1</p> <p>REFER TO OWNER'S MANUAL FOR MAINTENANCE AND ADJUSTMENTS.</p> <p>2013/06</p> <p>YANMAR YANMAR CO., LTD.</p>
Blow-by (Visual Observation Check)	No
Unusual Noises (Upon Start-up, Idle, Shutdown)	No
Unusual Noise Notes	No unusual noises heard
Engine Smoke (Upon Start-up, Idle, Shutdown)	No
Engine Smoke Notes	No engine smoke issues observed
Engine Exhaust Color	Clear
Battery	3 - Normal Wear & Tear
Battery Condition	Clean & dry appearance, tight connections
Radiator	3 - Normal Wear & Tear
Radiator Condition	Radiator fins & components appear to be in good working order, no signs of damage or leaks
Radiator Photos	

Inspection Report (Mini Excavator)

		
Belts	3 - Normal Wear & Tear	
Belt Condition	Belts appear in good condition & alignment with proper tension	
Hoses	3 - Normal Wear & Tear	
Hose Condition	Firm, pliant hoses with no signs of wear or leaks	
Hose Photos		
		



Inspection Report (Mini Excavator)

	
	
Water Pump	3 - Normal Wear & Tear
Water Pump Condition	No unusual pump noises heard
Cooling System Leaks	No
Coolant Color / Appearance	3 - Normal Wear & Tear
Coolant Color/Appearance Notes	Normal Translucent appearance, no visual signs of contamination
Oil Leaks	No
Oil Color / Appearance	3 - Normal Wear & Tear
Oil Color / Appearance Notes	Clean oil appearance, no signs of cross contamination, Appropriate oil level
Fuel Leaks	No
Equipped with DPF (Diesel Particulate Filter)	No
Requires DEF (Diesel Exhaust Fluid)	No
Overall Engine Appearance	Clean & dry
Overall Engine Comments	Overall engine in good condition with no leaks found. Maintenance kept up and engine sounds healthy.

Drivetrain Inspection Points

Drivetrain

Inspection Report (Mini Excavator)

Hydrostatic Transmission?	Yes
2 Speed?	Yes
Hydrostatic Drive Configuration	Split Transmission
Drive Motors	2 - Above Average Wear
Comments	Drive motors inaccessible for photos, sound and work well
Drive Motor Photos	
	
Hydrostatic Parking Brake	3 - Normal Wear & Tear
Hydrostatic Parking Brake Condition	Good brake function
Overall Drivetrain Comments	Overall drivetrain functions well

Chassis Inspection Points



Boom Condition	3 - Normal Wear & Tear
----------------	------------------------

Inspection Report (Mini Excavator)



Boom Photos





Inspection Report (Mini Excavator)

		
<p>Stick Condition</p>	<p>3 - Normal Wear & Tear</p>	
<p>Stick Photos</p>		
		
<p>Boom Base Pin & Bushings</p>	<p>3 - Normal Wear & Tear</p>	



Inspection Report (Mini Excavator)

<p>Boom Base Pin & Bushings Photos</p>	
	
	
<p>Boom to Stick Pin & Bushings</p>	<p>3 - Normal Wear & Tear</p>



Inspection Report (Mini Excavator)

<p>Boom to Stick Pin & Bushings Photos</p>	
	
<p>Stick to Bucket Pin & Bushings</p>	<p>3 - Normal Wear & Tear</p>
<p>Stick to Bucket Pin & Bushings Photos</p>	



Inspection Report (Mini Excavator)

		
		
<p>Turntable Bearing</p>	<p>3 - Normal Wear & Tear</p>	
<p>Turntable Bearing Photos</p>		

Inspection Report (Mini Excavator)

		
		
Bottom Covers	3 - Normal Wear & Tear	
Comments	Some bottom covers missing	
Bottom Covers Photos		

Inspection Report (Mini Excavator)



		
		
Overall Chassis	3 - Normal Wear & Tear	
Overall Chassis Comments	Overall chassis in good condition with no obvious major repairs needed.	

Undercarriage Inspection Points





Rubber Track Undercarriage

Roller Frames	3 - Normal Wear & Tear	
Roller Frames Photos		



Inspection Report (Mini Excavator)

		
Track Belt	3 - Normal Wear & Tear	
Comments	In great condition	
Track Belt Photos		
		

Inspection Report (Mini Excavator)

		
		
		
		
Rubber Belt Drive Lugs	3 - Normal Wear & Tear	
Track Tensioners	3 - Normal Wear & Tear	
Front Idlers	3 - Normal Wear & Tear	

Inspection Report (Mini Excavator)

Front Idlers Photos	
Rear Idlers	3 - Normal Wear & Tear
Track Rollers	3 - Normal Wear & Tear
Sprockets	3 - Normal Wear & Tear
Sprockets Photos	
	

Hydraulics Overall Inspection Points

Hydraulics Overall

Wet or Damp Hydraulic Lines / Fittings	No
Appearance of Hydraulic Lines / Fittings	3
Hydraulic Lines / Fittings Condition	Hydraulic lines & fittings are clean and in good condition

Inspection Report (Mini Excavator)



Appearance of Hydraulic Lines /
Fittings Photos



Inspection Report (Mini Excavator)



Inspection Report (Mini Excavator)

		
Unusual Noises (Hydraulic Pump)	No	
Hydraulic Pump Notes	No unusual noises heard during operation	
External Controls / Levers	3	
External Controls / Levers Condition	Good function & condition of hydraulic controls	
External Controls / Levers Photos		
		

Inspection Report (Mini Excavator)



Inspection Report (Mini Excavator)



Hydraulics Cylinders Inspection Points



Boom Cylinder	Check the boom cylinder. Note any wear, pitting, discoloration, etc. Take photos.
Boom Cylinder: Mounting Pin	3
Boom Cylinder: Oil Leaks	No





Inspection Report (Mini Excavator)

		
Stick Cylinder	Check the stick cylinder. Note any wear, pitting, discoloration, etc. Take photos.	
Stick Cylinder: Mounting Pin	3	
Stick Cylinder: Oil Leaks	No	
Stick Cylinder Photos		
		

Inspection Report (Mini Excavator)

		
Bucket Cylinder	Check the bucket cylinder. Note any wear, pitting, discoloration, etc. Take photos.	
Bucket Cylinder: Mounting Pin	3	
Bucket Cylinder: Oil Leaks	No	
Bucket Cylinder Photos		
		

Inspection Report (Mini Excavator)

	
	
Blade	Check the blade. Note any wear, pitting, discoloration, etc. Take photos.
Blade	3
Blade Photos	

Inspection Report (Mini Excavator)

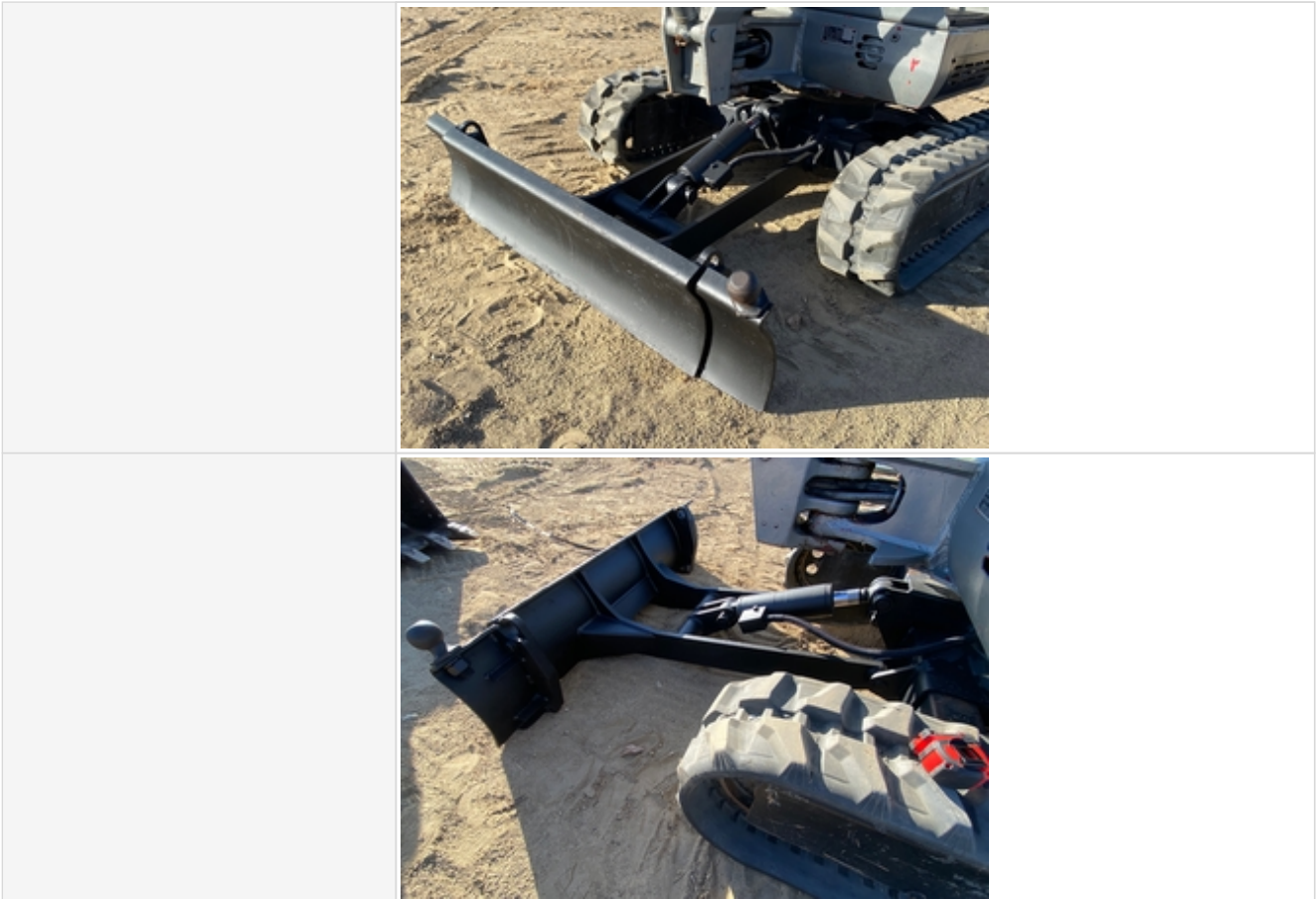

Bucket Inspection Points

<p>Bucket Condition</p>	<p>3 - Normal Wear & Tear</p>
<p>Bucket Photos</p>	

Inspection Report (Mini Excavator)



Additional Attachment Inspection Points

Additional Attachment(s)

Additional Attachments

Attachment Condition	3 - Normal Wear & Tear
----------------------	------------------------

Functional Test

Forward & Reverse	3 - Normal Wear & Tear
Swing Table Rotation	3 - Normal Wear & Tear
Boom Lift / Angle / Tilt	3 - Normal Wear & Tear
Operating Video	Click to Download

Overall Assessment

Overall Assessment

Exterior Rating	3
Interior Rating	3
Safety Rating	3
Quality Rating	3
Functionality Rating	3
Overall Rating	3
What's Great About the Machine	Machine functions well with no obvious repairs needed. Rubber Tracks have low use. No engine or hydraulic issues found.
What Needs Work	Some cosmetic scrapes on display unit. Left side armrest/ hydraulic enable mechanism may need to be adjusted (sticking closed). Boom light fixtures missing lens cover.
Date/Time	10-27-2022