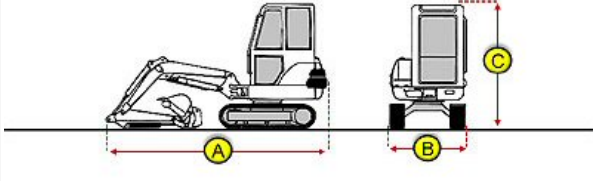

Inspection Report (Mini Excavator)

General Info

Year	2005
Make	Bobcat
Model	435 HAG
Serial Number	563211071
Hour Meter Reading	3,070
Previous Application (e.g., earth moving, mining, demolition, etc)	General Construction

Dimensions

Measurement Guide	
A. Length (ft and inches)	17'2"
B. Width (ft and inches)	6'4"
C. Height (ft and inches)	12'
Operational Weight (lbs)	10,802 LBS.



Features and Configuration

Control Station Type	Canopy
Bucket	Yes
Bucket Size (in inches)	18
Blade	Yes
Additional Attachment(s)	Yes
Hydraulic Coupler	No
Auxiliary Hydraulics	Yes
Hydraulic Thumb	No
Heat	No
A/C	No
Radio	No
Backup Camera	No
OMM (Operator & Maintenance Manual)	No
Telematics	No

Exterior Walkaround Photos

Inspection Report (Mini Excavator)

Exterior 360 Walkaround

<p>Instructions</p>	<p>Take photos of the exterior of the piece of equipment. Capture a full 360 degree walk around and all major components.</p> <p>Must have shots to capture:</p> <ul style="list-style-type: none"> - Front - 45 degree corner shot of left front - 45 degree corner shot of right front - Left side - Right side - Rear - 45 degree corner shot of left rear - 45 degree corner shot of right rear <p>Tips for good photos:</p> <ul style="list-style-type: none"> - Move the equipment into a open area without any visual distractions or other equipment in the background
<p>Exterior Walkaround Photos</p>	
	

Inspection Report (Mini Excavator)



Inspection Report (Mini Excavator)



General Appearance Inspection Points

General Appearance



Front	3 - Normal Wear & Tear
Front Condition	No visible damage

Inspection Report (Mini Excavator)

Front Photos



Inspection Report (Mini Excavator)



	
	
	
Rear	3 - Normal Wear & Tear
Rear Condition	No visible damage

Inspection Report (Mini Excavator)



Rear Photos



Inspection Report (Mini Excavator)

		
Left	3 - Normal Wear & Tear	
Left Condition	No visible damage	
Left Photos		
		

Inspection Report (Mini Excavator)

	
	
<p>Right</p>	<p>3 - Normal Wear & Tear</p>
<p>Right Condition</p>	<p>No visible damage</p>
<p>Right Photos</p>	

Inspection Report (Mini Excavator)



Inspection Report (Mini Excavator)

	
	
Upper	3 - Normal Wear & Tear
Upper Condition	No visible damage
Upper Photos	
Body Panels (Any Rust Damage?)	3 - Normal Wear & Tear
Body Panel Condition	No visible damage, good paint condition and panel fitment
Doors / Canopy Latches	3 - Normal Wear & Tear
Steps / Ladders	3 - Normal Wear & Tear
Handrails	3 - Normal Wear & Tear

Inspection Report (Mini Excavator)



Glass Condition	0
Mirrors	0
Lighting System	3 - Normal Wear & Tear
Lighting System Condition	No visible damage, lighting system is operational
Lighting System Photos	

Control Station Inspection Points

Control Station

Serial Number Plate Photo	
Operator Cabin Overall	3 - Normal Wear & Tear



Inspection Report (Mini Excavator)

Operator Cabin Overall Condition	Good cabin appearance, solid floors, panels, and ceiling
Operator Cabin Photos	
	
	

Inspection Report (Mini Excavator)



Inspection Report (Mini Excavator)



	
Operator's Seat & Arm Rests	3 - Normal Wear & Tear
Operator's Seat & Arm Rests Condition	Seat(s) in good condition, no stains or tears in upholstery
Operator's Seat & Arm Rests Photos	
Seat Belt	3 - Normal Wear & Tear
Seat Belt Condition	Seat belt secures properly. Belt is intact and in good condition
Cabin Lights	0
Safety Lock Out / Stop	3 - Normal Wear & Tear
Safety Lock Out / Stop Condition	Safety lock out device is present, in good condition, and functional
Controls & Switches	3 - Normal Wear & Tear
Controls & Switches Condition	All switches are installed and functional

Inspection Report (Mini Excavator)

Controls & Switches Photos



Inspection Report (Mini Excavator)

		
Hour Meter Activity	3 - Normal Wear & Tear	
Hour Meter Condition	Hour meter is functional and in good condition	
Hour Meter Activity Photos		
Other Gauge Activity	3 - Normal Wear & Tear	
Other Gauge Condition	All cockpit gauges are functional and in good condition	
Other Gauge Activity Photos		
Heater & A/C	0	
Fans / Vents	0	
Travel Alarm	2 - Above Average Wear	

Inspection Report (Mini Excavator)

Travel Alarm Condition	System is configured but not operating correctly
Horn	2 - Above Average Wear
Horn Condition	Horn installed but functioning improperly
Backup Camera	0
Fire Extinguisher	0
First Aid Kit	0

Engine Inspection Points

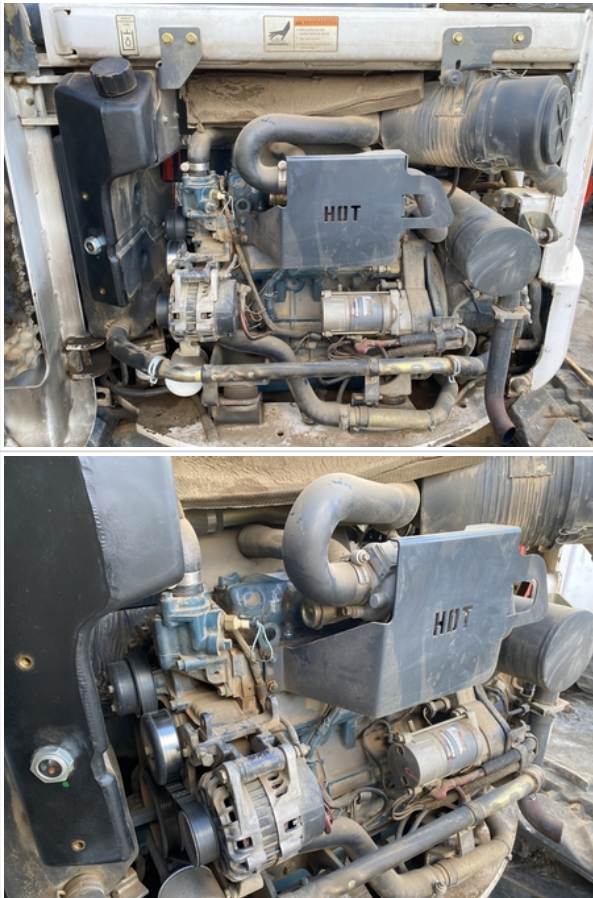

Engine

Engine Type (Make, Model, Cylinders, Hp)	Kubota - V2003MDITE2BBC1 - 4CYL - 49HP - 2.0L
Emissions Tier	Tier 2
Engine Serial Number	N/A
Engine Fuel Type	Diesel
Engine Photos	

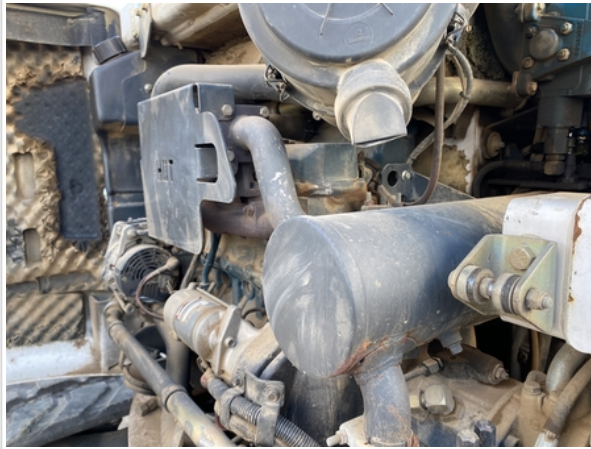

Inspection Report (Mini Excavator)





Inspection Report (Mini Excavator)

		
Blow-by (Visual Observation Check)	No	
Unusual Noises (Upon Start-up, Idle, Shutdown)	No	
Unusual Noise Notes	No unusual noises heard	
Engine Smoke (Upon Start-up, Idle, Shutdown)	No	
Engine Smoke Notes	No engine smoke issues observed	
Engine Exhaust Color	Clear, Other (see comments)	
Comments	Minor smoke at startup, goes away once warmed up	
Battery	3 - Normal Wear & Tear	
Battery Condition	Like new, recently replaced, Dusty & dirty appearance	
Comments	Battery just replaced	
Battery Condition Photos		
Radiator	3 - Normal Wear & Tear	
Radiator Condition	Radiator fins & components appear to be in good working order, no signs of damage or leaks	



Inspection Report (Mini Excavator)

Radiator Photos	
	
	
Belts	3 - Normal Wear & Tear
Belt Condition	Belts appear in good condition & alignment with proper tension

Inspection Report (Mini Excavator)

Belt Photos	
Hoses	3 - Normal Wear & Tear
Hose Condition	Firm, pliant hoses with no signs of wear or leaks
Hose Photos	
	

Inspection Report (Mini Excavator)

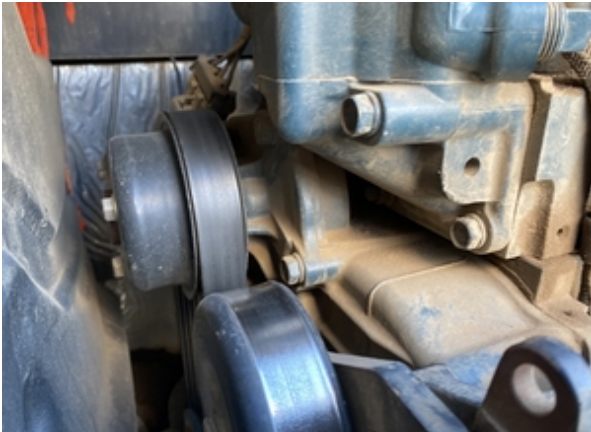

	
	
Water Pump	3 - Normal Wear & Tear
Water Pump Condition	No unusual pump noises heard
Water Pump Photos	
Cooling System Leaks	No
Coolant Color / Appearance	3 - Normal Wear & Tear
Coolant Color/Appearance Notes	Normal Translucent appearance, no visual signs of contamination
Oil Leaks	No
Oil Color / Appearance	3 - Normal Wear & Tear

Inspection Report (Mini Excavator)

Oil Color / Appearance Notes	Clean oil appearance, no signs of cross contamination, Appropriate oil level
Fuel Leaks	No
Equipped with DPF (Diesel Particulate Filter)	No
Requires DEF (Diesel Exhaust Fluid)	No
Overall Engine Appearance	Dusty & dry
Overall Engine Comments	Overall engine in good condition. No active leaks seen and no obvious major problems seen.

Drivetrain Inspection Points



Drivetrain

Hydrostatic Transmission?	Yes
2 Speed?	Yes
Hydrostatic Drive Configuration	Split Transmission
Drive Motors	2 - Above Average Wear
Drive Motor Photos	
	
Hydrostatic Parking Brake	3 - Normal Wear & Tear
Hydrostatic Parking Brake Condition	Good brake function



Inspection Report (Mini Excavator)

Overall Drivetrain Comments	Overall drivetrain in solid condition.
-----------------------------	--



Chassis Inspection Points

Boom Condition	3 - Normal Wear & Tear
Boom Photos	
	
	

Inspection Report (Mini Excavator)

	
<p>Stick Condition</p>	<p>3 - Normal Wear & Tear</p>
<p>Stick Photos</p>	
	

Inspection Report (Mini Excavator)



		
		
Boom Base Pin & Bushings	3 - Normal Wear & Tear	
Boom to Stick Pin & Bushings	3 - Normal Wear & Tear	
Stick to Bucket Pin & Bushings	3 - Normal Wear & Tear	
Comments	Stick to bucket coupler has some play (may need bushings or spacers)	
Turntable Bearing	3 - Normal Wear & Tear	
Turntable Bearing Photos		
Bottom Covers	3 - Normal Wear & Tear	
Overall Chassis	3 - Normal Wear & Tear	

Inspection Report (Mini Excavator)



Overall Chassis Comments	Overall chassis in good condition. The excess play from stick to bucket coupler should be addressed.
--------------------------	--

Undercarriage Inspection Points

Rubber Track Undercarriage

Roller Frames	3 - Normal Wear & Tear
Roller Frames Photos	
	
	



Inspection Report (Mini Excavator)

		
Track Belt	3 - Normal Wear & Tear	
Comments	About 30% to 40%	
Track Belt Photos		
		



Inspection Report (Mini Excavator)





Inspection Report (Mini Excavator)

		
Rubber Belt Drive Lugs	3 - Normal Wear & Tear	
Rubber Belt Drive Lugs Photos		
		
Track Tensioners	3 - Normal Wear & Tear	
Front Idlers	3 - Normal Wear & Tear	

Inspection Report (Mini Excavator)

<p>Front Idlers Photos</p>		
		
<p>Rear Idlers</p>	<p>0</p>	
<p>Track Rollers</p>	<p>3 - Normal Wear & Tear</p>	
<p>Track Rollers Photos</p>		

Inspection Report (Mini Excavator)

		
		
<p>Sprockets</p>	<p>3 - Normal Wear & Tear</p>	
<p>Sprockets Photos</p>		

Inspection Report (Mini Excavator)



Hydraulics Overall Inspection Points

Hydraulics Overall

Wet or Damp Hydraulic Lines / Fittings	Yes
Appearance of Hydraulic Lines / Fittings	3 - Normal Wear & Tear
Hydraulic Lines / Fittings Condition	Hydraulic lines & fittings are clean and in good condition, Active leaks in hoses or fittings observed, Other (see comments)
Comments	Observed signs of small hydraulic leaks at main control valve

Appearance of Hydraulic Lines / Fittings Photos



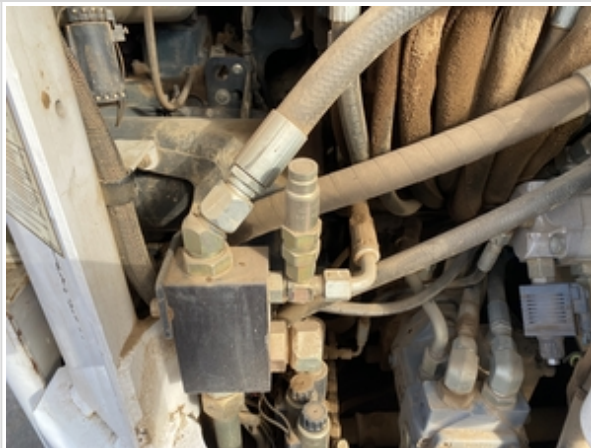
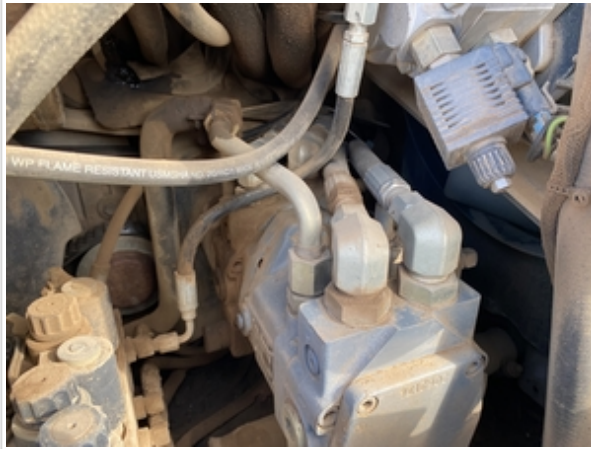

Inspection Report (Mini Excavator)

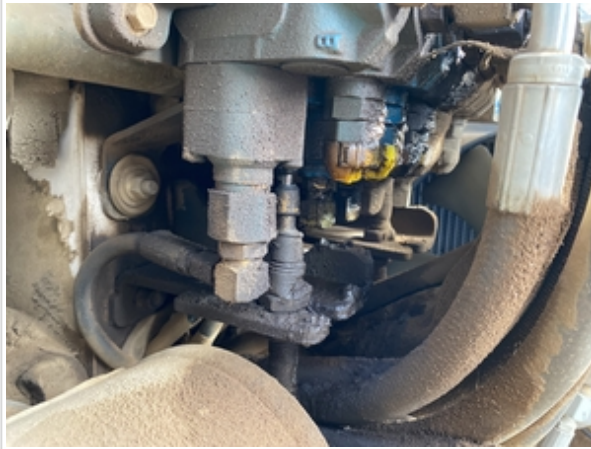

Inspection Report (Mini Excavator)



Inspection Report (Mini Excavator)

		
		
Unusual Noises (Hydraulic Pump)	No	
Hydraulic Pump Notes	No unusual noises heard during operation	
External Controls / Levers	3 - Normal Wear & Tear	
External Controls / Levers Condition	Good function & condition of hydraulic controls	
External Controls / Levers Photos		

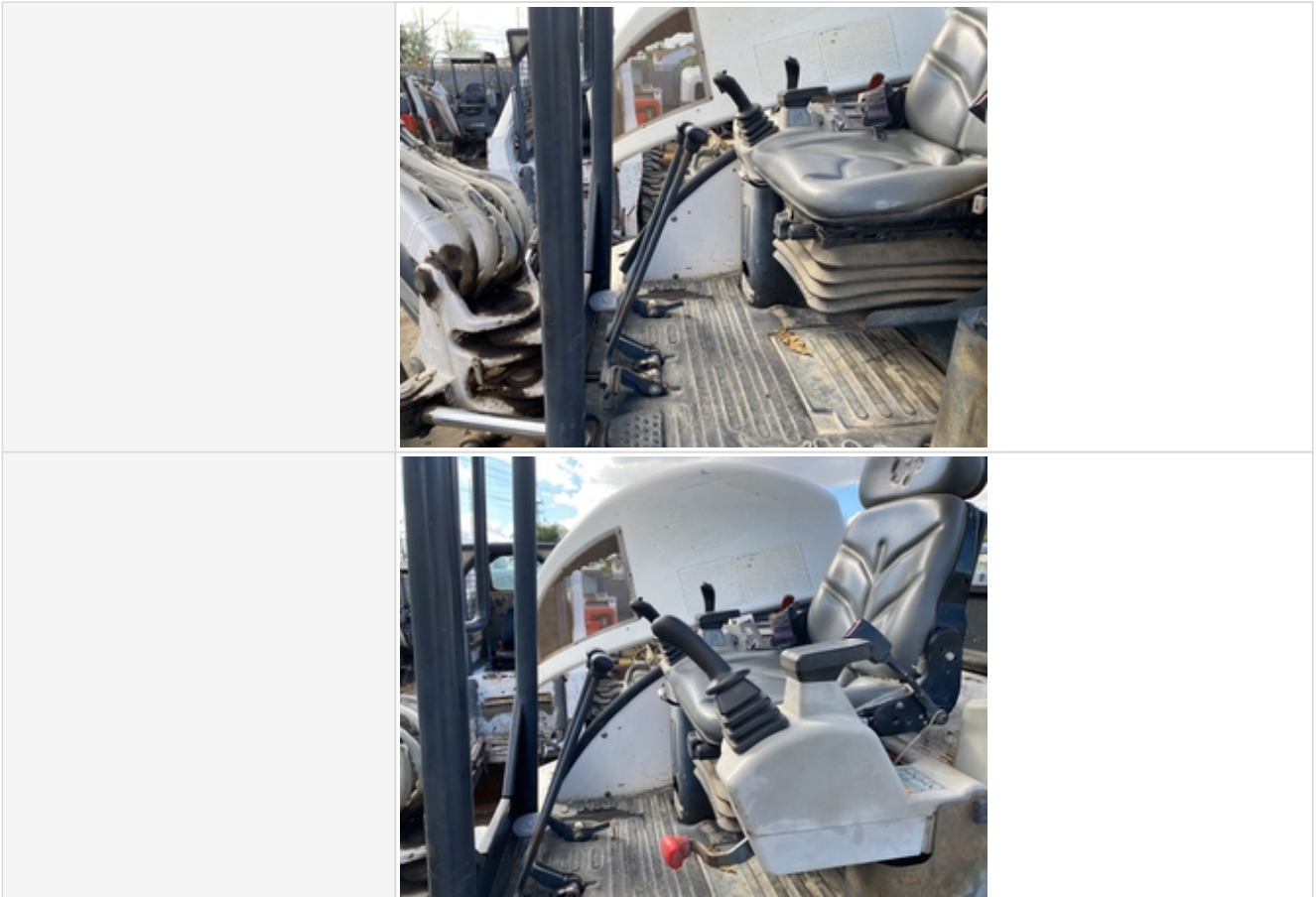

Inspection Report (Mini Excavator)





Hydraulics Cylinders Inspection Points

Boom Cylinder: Mounting Pin	3 - Normal Wear & Tear
Boom Cylinder: Oil Leaks	No
Boom Cylinder Photos	

Inspection Report (Mini Excavator)

	
	
Stick Cylinder: Mounting Pin	3 - Normal Wear & Tear
Stick Cylinder: Oil Leaks	No
Stick Cylinder Photos	
Bucket Cylinder: Mounting Pin	3 - Normal Wear & Tear
Bucket Cylinder: Oil Leaks	No



Inspection Report (Mini Excavator)

Bucket Cylinder Photos	
	
Blade	3 - Normal Wear & Tear
Blade Photos	

Bucket Inspection Points

Bucket Condition	3 - Normal Wear & Tear
Comments	18" and 30"



Inspection Report (Mini Excavator)

<p>Bucket Photos</p>	
	
	



Inspection Report (Mini Excavator)

	
Bucket Hose & Fittings	3 - Normal Wear & Tear
Bucket Cylinder	3 - Normal Wear & Tear
Comments	Left side may need to be resealed soon

Blade Inspection Points

Blade Condition	3 - Normal Wear & Tear
Blade Photos	
	
Blade Edge	3 - Normal Wear & Tear
Blade Hose & Fittings	3 - Normal Wear & Tear

Inspection Report (Mini Excavator)

Blade Cylinder	3 - Normal Wear & Tear
Comments	Oil seepage observed at left side blade cylinder rod seal
Blade Cylinder Photos	
	
	

Additional Attachment Inspection Points

Additional Attachment(s)

Additional Attachments

Attachment Condition	0
----------------------	---

Functional Test

Inspection Report (Mini Excavator)

Forward & Reverse	3 - Normal Wear & Tear
Swing Table Rotation	3 - Normal Wear & Tear
Boom Lift / Angle / Tilt	3 - Normal Wear & Tear
Blade Functionality	3 - Normal Wear & Tear
Overall Functional Test Comments	Overall machine functions normal. Powertrain runs great with no major problems observed.
Operating Video	Click to Download

Overall Assessment

Overall Assessment

Exterior Rating	3 - Normal Wear & Tear
Interior Rating	3 - Normal Wear & Tear
Safety Rating	3 - Normal Wear & Tear
Quality Rating	3 - Normal Wear & Tear
Functionality Rating	3 - Normal Wear & Tear
Overall Rating	3 - Normal Wear & Tear
What's Great About the Machine	Machine is well maintained and running strong. This excavator has two buckets and auxiliary hydraulics. The machine is well kept in and out and no major active leaks observed.
What Needs Work	Some cylinders may need to be resealed soon. Control valve has minor leakage. Horn and backup alarm not functioning properly.
Date/Time	12-08-2022