



**casagrande**

**B160 XP**

**XP**

**B160**

**HYDRAULIC PILING RIG**

ATTREZZATURA IDRAULICA PER PALI



# TECHNICAL SPECIFICATIONS

## DATI TECNICI

<b>PILING</b>	<b>PALI</b>	
Max depth	Profondità max	50 m
Max diameter with casing - Crowd ram	Diametro max con tubo - Martinetto pull-down	1500 mm
Max diameter with casing oscillator	Diametro max con morsa giracolonna	1000 mm
<b>C.F.A. CONTINUOUS FLIGHT AUGER</b>	<b>ELICA CONTINUA C.F.A.</b>	
Max depth	Profondità max	23 m
Max diameter	Diametro max	800 mm
<b>SOIL MIXING</b>	<b>SOIL MIXING</b>	
Max depth	Profondità max	21 m
Max diameter	Diametro max	1000 mm
<b>UNDERCARRIAGE</b>	<b>CARATTERISTICHE CARRO</b>	
Width with retracted/extended tracks	Larghezza con cingoli chiusi/ aperti	2500/3700 mm
Tracks length	Lunghezza cingoli	4510 mm
Shoes width	Larghezza pattini	600 mm
<b>ENGINE</b>	<b>MOTORE</b>	<b>CUMMINS QSB 6.7 Aftercooler</b>
Engine conforms to Exhaust Emission Standard	Motore conforme agli standard di emissione	EU Stage IIIA/IV - US EPA Tier III/IVf
Power at 2200 rpm	Potenza a 2200 giri	164/168 kW
Hydraulic power	Potenza idraulica	140 kW
<b>MAIN WINCH</b>	<b>ARGANO PRINCIPALE</b>	
Nominal line pull on 1 <sup>st</sup> layer	Tiro nominale 1° strato	160 kN
Max line speed	Velocità max fune	72 m/min
<b>AUXILIARY WINCH</b>	<b>ARGANO AUSILIARIO</b>	
Nominal line pull on 1 <sup>st</sup> layer	Tiro nominale 1° strato	70 kN
Max line speed	Velocità max fune	63 m/min
<b>ROTARY HEAD</b>	<b>TESTA ROTARY</b>	<b>H18</b>
Max torque	Coppia max	160 kNm
Max drilling speed	Velocità max lavoro	33 rpm
Discharge speed	Velocità di scarico	120 rpm
<b>CROWD RAM</b>	<b>MARTINETTO PULL-DOWN</b>	
Max line pull	Tiro max	205 kN
Max crowd	Spinta max	140 kN
Stroke	Corsa	5200 mm
<b>MAST INCLINATION</b>	<b>INCLINAZIONE MAST</b>	
Forward   Backward   Lateral	Avanti   Indietro   Laterale	3°   15°   ±3°
<b>WEIGHT</b>	<b>PESO</b>	
Weight in working condition	Attrezzatura in condizioni di lavoro	~ 42 t

# PILING ARRANGEMENT - PDC

ALLESTIMENTO PALI - PDC

**B160**  
HYDRAULIC PILING RIG

XP

CROWD RAM - MARTINETTO PULL-DOWN

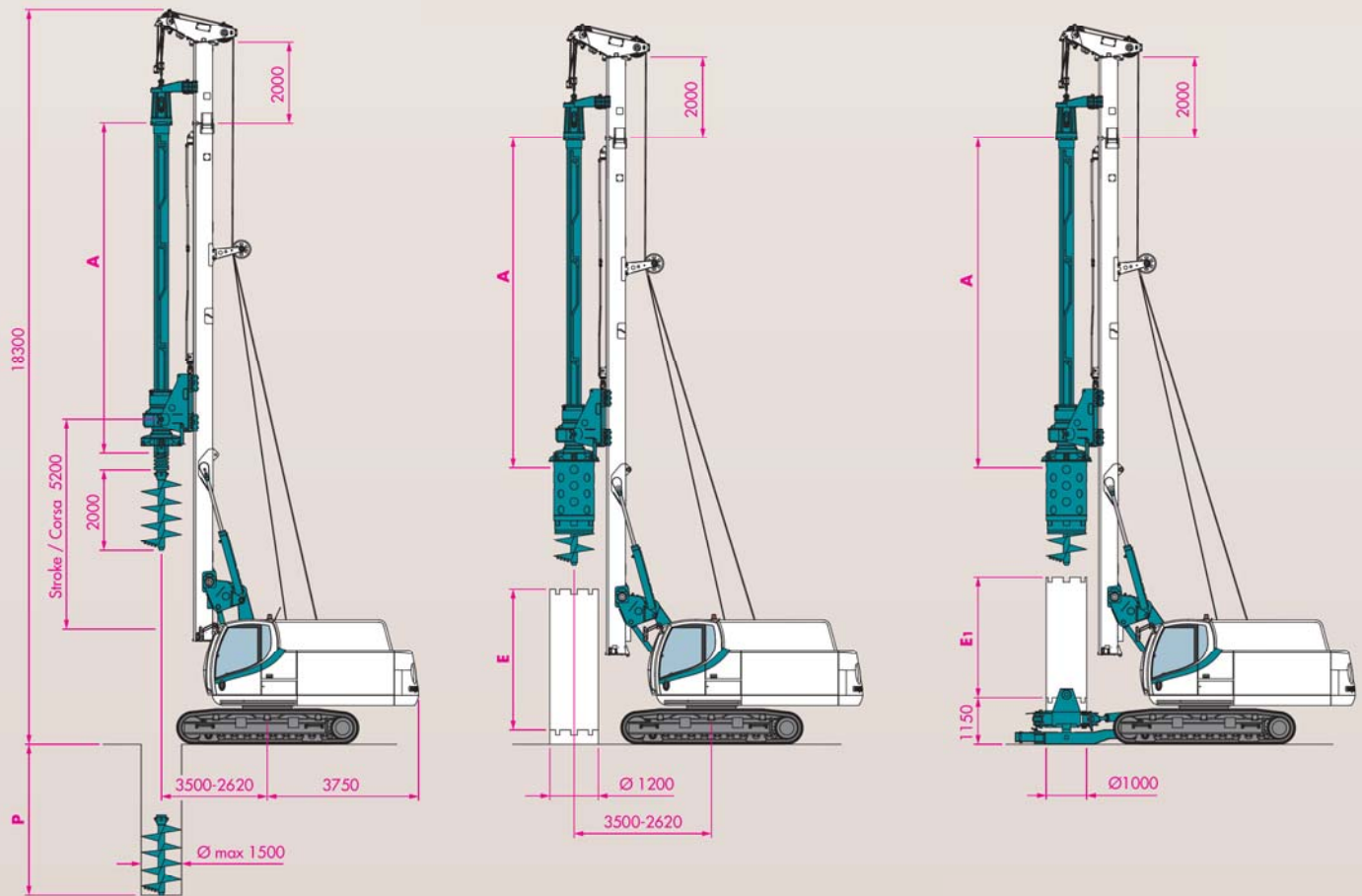

DRILLING DEPTH		PROFONDITÀ DI SCAVO				
Nominal kelly bars length	Larghezza nominale aste	<b>A</b>	<b>7500</b>	<b>9500</b>	<b>11000</b>	
Kelly bars 4 element	Aste a 4 elementi	m	<b>P</b>	26	34	40
Kelly bars 5 element	Aste a 5 elementi	m	<b>P</b>	32	42	50
Casing length	Lunghezza tubo	mm	<b>E</b>	4000	2500	—
Casing length with oscillator	Lunghezza tubo con morsa	mm	<b>E<sub>1</sub></b>	3500	1500	—

## TRANSPORT DIMENSIONS

DIMENSIONI DI TRASPORTO

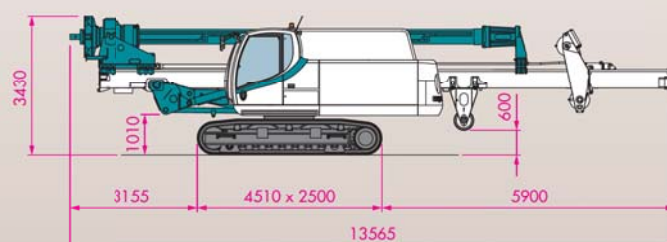

**WEIGHT · PESO**

~ 41 t

with kelly bars · con aste 9500

# PILING ARRANGEMENT - PDC-L

ALLESTIMENTO PALI - PDC-L

**B 160**  
HYDRAULIC PILING RIG

XP

CROWD RAM - MARTINETTO PULL-DOWN

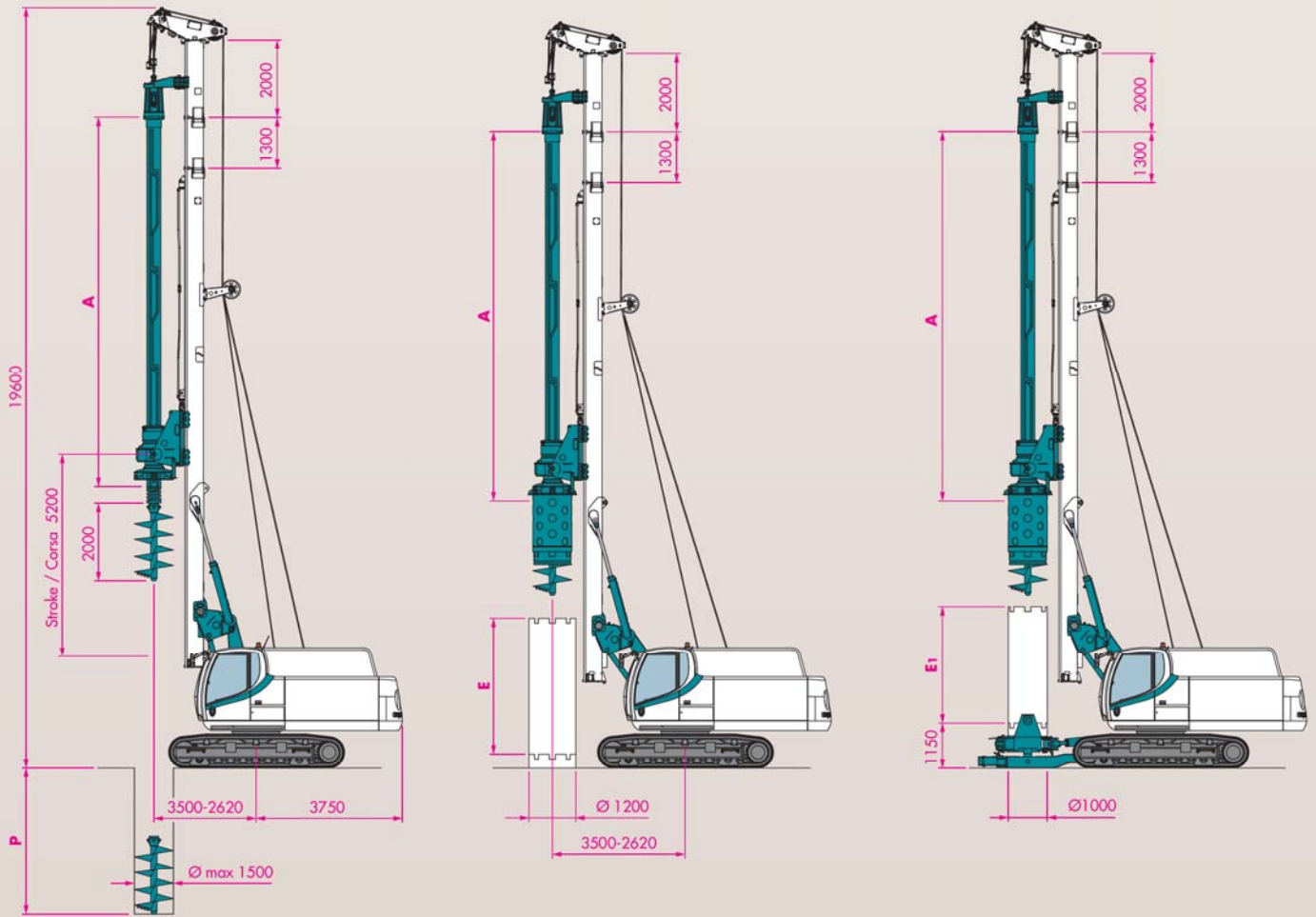

DRILLING DEPTH	PROFONDITÀ DI SCAVO		A	7500	9500	11000
Nominal kelly bars length	Larghezza nominale aste					
Kelly bars 4 element	Aste a 4 elementi	m	P	26	34	40
Kelly bars 5 element	Aste a 5 elementi	m	P	32	42	50
Casing length	Lunghezza tubo	mm	E	4000	4000	2500
Casing length with oscillator	Lunghezza tubo con morsa	mm	E <sub>1</sub>	3500	3000	1500

## TRANSPORT DIMENSIONS

DIMENSIONI DI TRASPORTO

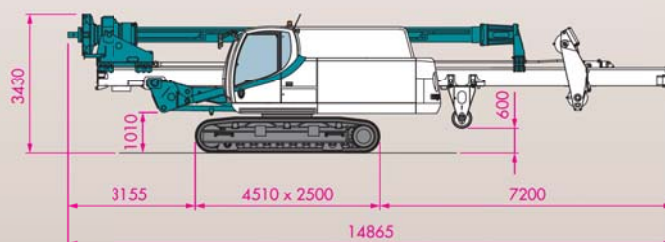

**WEIGHT • PESO**

~ 41 t

with kelly bars · con aste 9500



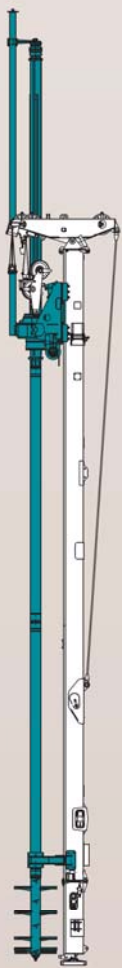

**SOIL MIXING**  
Depth 21 m  
Ø 1000 mm

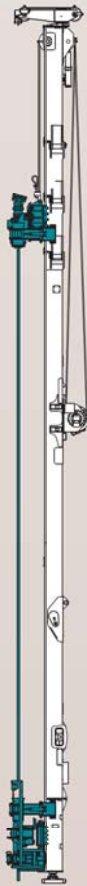

**MICROPILING**  
Stroke 16 m  
Ø 90 ÷ 406 mm

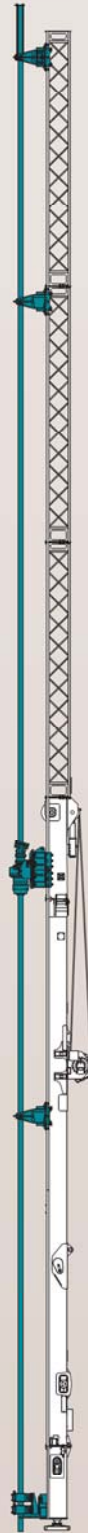

**JET GROUTING**  
Depth 68 m  
with rod loader  
Ø 90 ÷ 406 mm

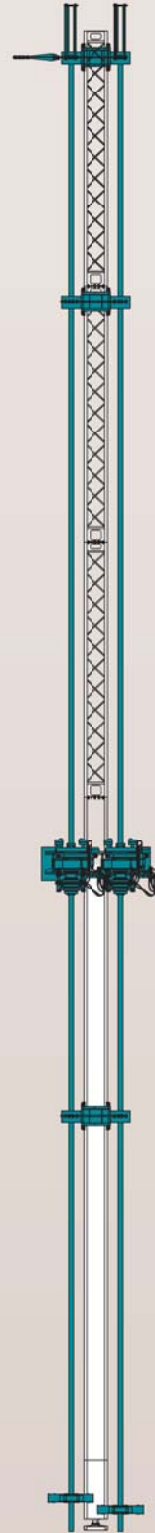

**BI-JET GROUTING**  
Depth 32 m  
Ø 40 ÷ 254 mm

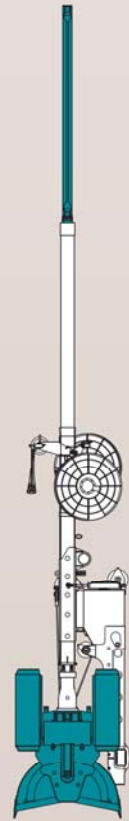

**KRC DIAPHRAGM WALL**  
Depth 30 m  
Trench 800 x 2500 mm

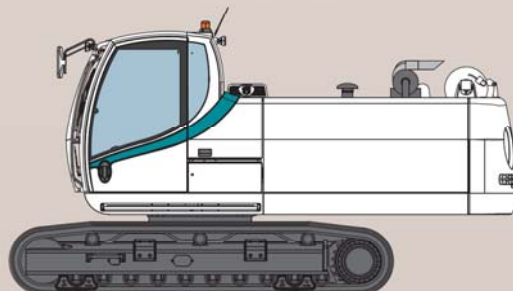

# CASAGRANDE HYDRAULIC PILING RIGS RANGE



B125XP



B175XP



B200XP

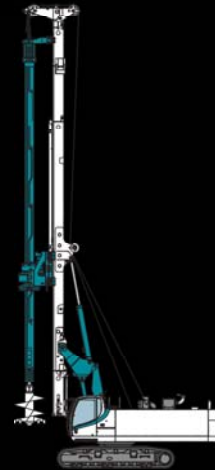

B250XP

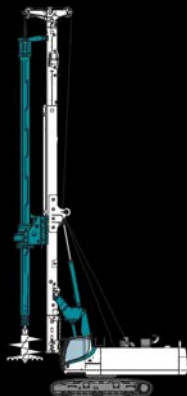

B300XP

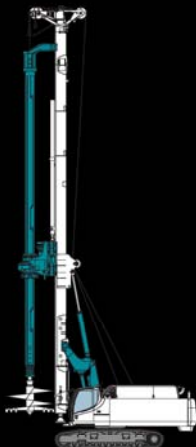

B360XP

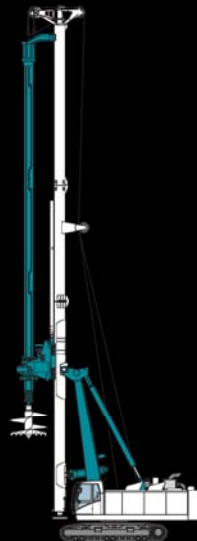

C850

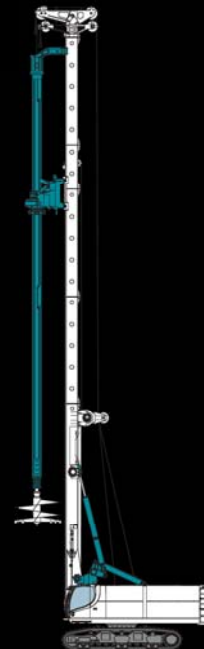

B450XP

All data contained in this brochure are indicative and does not take power losses into account. All data can be changed without notice.  
Tutti i dati riportati su questo catalogo sono indicativi e non considerano perdite di carico. Tali dati possono variare senza preavviso.



CASAGRANDE S.P.A.  
Via A. Malignani, 1 • IT 33074 Fontanafredda • Pordenone • Italy  
Tel. (+39) 0434 9941 • Fax (+39) 0434 997009  
www.casagrandegroup.com • info@casagrandegroup.com

