



Instructions for CAPELLA LED Ceiling Light

Model No	20096/05
Wattage	18W

Before first using your new Brilliant LED Ceiling Light it is most important that you read and follow these instructions, even if you feel you are quite familiar with this type of product. Retain this document for future reference.

THIS FIXTURE MUST BE INSTALLED BY A QUALIFIED ELECTRICIAN

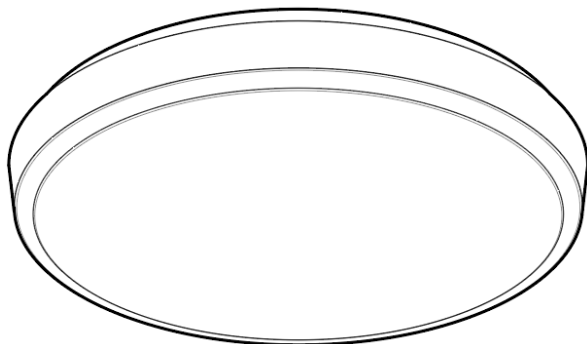

Specifications:

- Fitting : Fixed LED luminaire with and PC body and diffuser
- Rated Voltage: 240V AC, 50Hz
- Wattage: 18W
- Lumens: 1500lm (Warm White), 1650lm (Cool White), 1600lm (Daylight)
- CCT: Adjustable (3000K, 4500K, 6500K)
- Lamp type: LED (Non replaceable)
- Protection: Class II, IP54
- Fixing: Surface mounted. Intended to be used while fastened to a support
- Dimming: Not Dimmable

For Your Safety, please read this instruction manual carefully before installation:

- Installation, repair and/or inspection must be conducted by qualified personnel in accordance with Australian Standards and local Building codes.
- Do not install in a position where the fixture can be easily accessed by children or infirm persons.
- Do not perform modification to the fitting.
- Do not touch the fitting when switched on.
- This fitting is not dimmable.
- Ensure fitting is kept as far as possible from heat sources when installed.
- Failure to follow these instructions will void the warranty.

Environmental Protection:

This electrical product should not be disposed as normal waste. Please always recycle!
Check with your Local Council about your recycle options.





Instructions for CAPELLA LED Ceiling Light

Model No	20096/05
Wattage	18W

1. Take out ceiling light and accessory pack from box

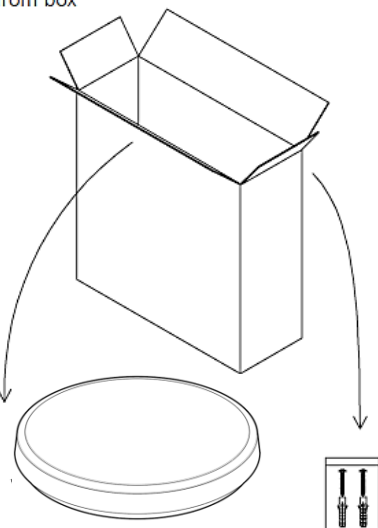

2. Knock-in the plastic anchor into ceiling

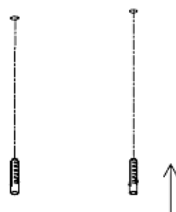

3. Remove screw, take out bracket

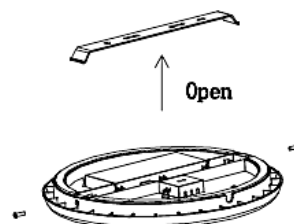

4. Fix bracket with screw into the ceiling

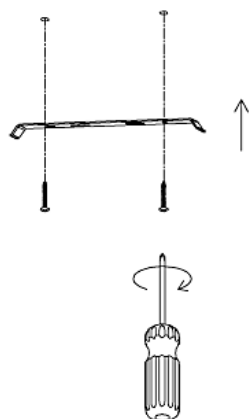

5. Open junction box, wire "L" "N" to terminal block and mount ceiling light into the right place

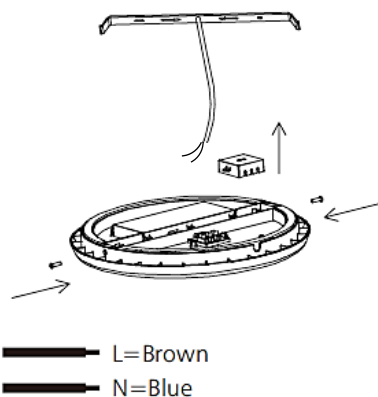

6. Switch on

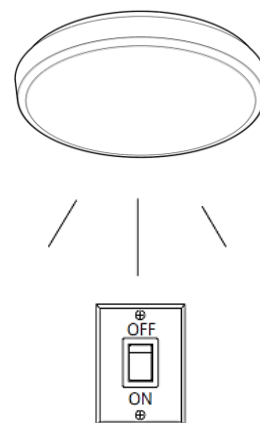

Installation Instructions:

1. Ensure mains supply is switched OFF.
2. Remove light fitting & mounting screws from packaging and dispose of packaging thoughtfully.
3. Remove mounting bracket from the back of fitting via two screws.
4. Use the bracket as a template to mark and drill mounting holes into the mounting surface.
5. Mount the bracket to the mounting surface using screws provided.
6. Open junction box and connect mains wiring to terminal block.
7. Select desired CCT(3000K, 4500K or 6500K) by toggling the switch on back of fitting.
8. Mount light fitting to the bracket and tighten side screws.
9. Turn the power on.



Instructions for CAPELLA LED Ceiling Light

Model No	20096/05
Wattage	18W

Warranty:

Brilliant Lighting warrants this product against defects in manufacture and workmanship for a period of 3 years from date of purchase or as specified on the packaging. For products used in non-domestic or commercial applications, Brilliant Lighting warrants this product for a period of 3 months from date of purchase. This warranty is only valid for products installed and operated within the guidelines specified by Brilliant Lighting, and within the correct operating voltage ranges as stated on the product's rating label.

Warranty does not include damage or loss arising from incorrect installation, operation or maintenance of this product, damage caused through modification, incorrect installation, service by unqualified or unauthorised personnel or lack of regular maintenance and cleaning. Proof of installation by qualified personnel may be required, e.g. Electrical Safety Certificate. Proof of purchase must be supplied with all warranty claims.

This warranty is provided in addition to any other rights and remedies of the customer under any law. In applications not intended for household, personal or domestic use, liability is limited to replacement or reimbursement of product only. Brilliant Lighting does not warranty the costs of removal or re-installation of this product or associated components.

Our goods come with guarantees that cannot be excluded under the Australian Consumer Law. You are entitled to a replacement or refund for a major failure and compensation for any other reasonably foreseeable loss or damage. You are also entitled to have the goods repaired or replaced if goods fail to be of acceptable quality and the failure does not amount to a major failure.

Any claim under this warranty must be made within the specified warranty period from date of purchase of this product. To make a claim under the warranty; at your own expense take the product (with proof of purchase – receipt or similar) to the store where you purchased the product or contact Brilliant Lighting at the address below

This warranty is given by:

Brilliant Lighting (Aust) Pty. Ltd.
ABN 37 006 203 694
956 Stud Road Rowville, VIC 3178
Phone: 03 9765 2555
Email: info@brilliantlighting.com.au
www.brilliantlighting.com.au