



EYE 360 MINI PIR SENSOR SERIES II

21353

Thank you for purchasing a Brilliant EYE 360° MINI RECESSED PIR SECURITY SENSOR. The EYE 360° MINI sensor helps to safe-guard your home or business by sensing movement, and switching lighting devices on to illuminate the source of the movement. The EYE 360° MINI is intended for installation in a fixed location by a Licenced Electrical Contractor

For Your Safety

- To prevent electrical shock, please ensure that power is DISCONNECTED before installing.
- Be aware of the height of your installation. Refer to 'Working at Heights " guide from your local or State Authorities.
- Any alterations or additions to building wiring must be completed by a licensed electrician or person authorised by legislation to work on the fixed wiring of any electrical installation.

THIS FITTING MUST BE INSTALLED BY A QUALIFIED ELECTRICAL CONTRACTOR in accordance with the latest AS/NZS 3000 and relevant amendments

Before first using your new Brilliant EYE 360° MINI RECESSED PIR SECURITY SENSOR, it is most important that you read and follow these instructions, even if you feel you are quite familiar with this type of product. Keep this document handy for future reference.

Introduction

This product must be used only as described in this manual. Any other use not recommended by the manufacturer may cause fire, electric shock, or injury to persons.

Your EYE 360° MINI RECESSED PIR SECURITY SENSOR incorporates a highly sensitive PIR (Passive Infra Red) sensor which continuously scans the selected detection area and immediately activates connected lighting devices when it detects movement within the detection area.

The EYE 360° MINI uses a relay to automatically switch loads when it detects movement. The load can be light fittings, ceiling Fans, exhaust Fans, etc

The EYE 360° MINI sensor has two adjustable controls: Time and LUX knobs.

Selecting a Location

To achieve best results, please read the following carefully, and save these instructions for future reference.

- The EYE 360° MINI is suitable to be installed on ceiling
- Best results are achieved when detection occurs when movement is across the scanning beam, rather than directly towards or away from it. Select a mounting position where detection will occur across the scanning area.
- The EYE 360° MINI should be mounted 2.2 to 4 metres above the selected area. The sensor detection area will vary depending on mounting height and location.
- The detection range of your sensor may alter with changes in temperature and ambient light.
- To avoid false detection's, your sensor should be directed away from sources of heat and movement such as barbecues, air conditioners, street lighting, moving cars, fountains, sprinklers or flue vents.
- To avoid false detection your sensor should be kept away from sources of strong electromagnetic fields and disturbances.
- DO NOT direct your sensor towards reflective surfaces such as swimming pools and spa's, white walls, shiny floor boards etc.

Please consider your neighbours when selecting a suitable location for any attached security lighting.

Installation

- 1) Ensure the power is switched off.
- 2) Ensure that there are no hidden cables or utilities in the ceiling or wall before cutting the hole in the plaster.
- 3) Use 44mm hole saw and carefully cut the hole in the plaster. (use appropriate personal protection equipment). FIG 1.
- 4) Remove the transparent terminal block cover 'A' at the top of the sensor. FIG 2.
- 5) Connect the Active incoming supply connection to the connection on terminal block 'B', marked "L", Wire the incoming supply Neutral and the load Neutral connection to the terminal block 'B' connection marked "N", Wire the load active connection to the switched Active output connection on the terminal block, marked "A", as per FIG 3, FIG 4.
- 6) Refit terminal block cover "A" to the top of the sensor. FIG 3.
- 7) Remove front cover of the sensor by twisting it anti-clockwise. FIG 5.
- 8) Change settings of the sensor to desired values by adjusting two knobs: LUX and Time. (e.g. turn the LUX knob clockwise on the maximum (☀️). Turn the TIME knob anti-clockwise on the minimum (10s.) FIG 6.
- 9) Push the side springs 'C' of the sensor upwards and gently locate the sensor body through the hole and ensure it is flush against the ceiling. FIG 7, FIG 8.
- 10) Turn the power on.

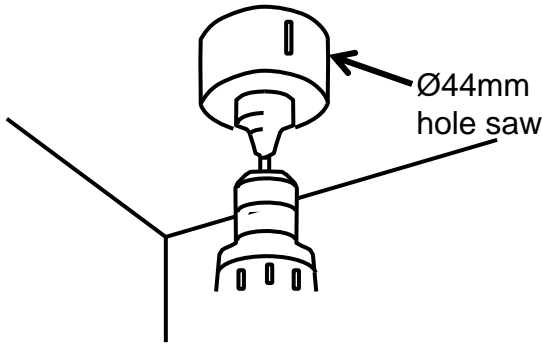

FIG 1

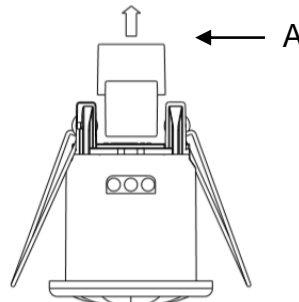

FIG 2

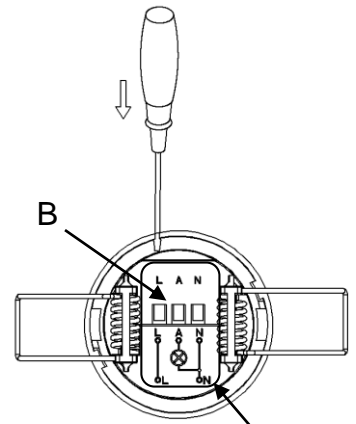

FIG 3

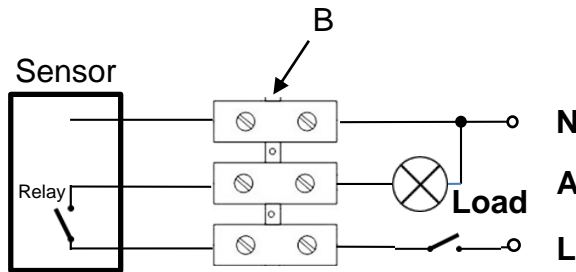

FIG 4



FIG 5

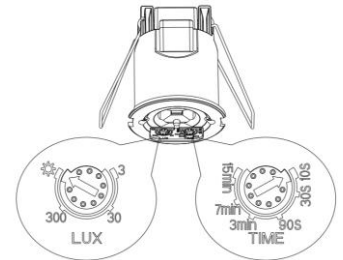

FIG 6

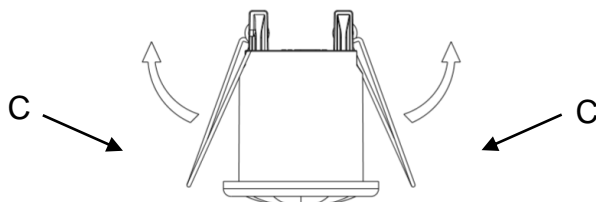

FIG 7

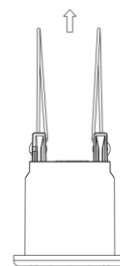

FIG 8

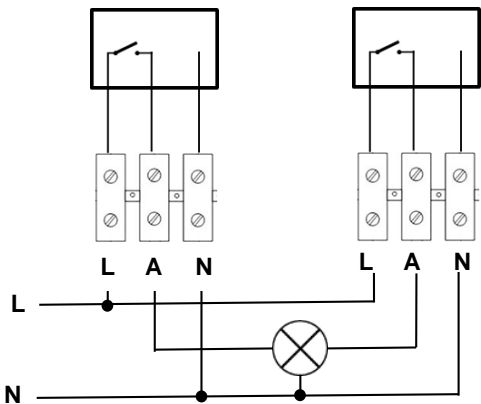

FIG 3. Switching one load with multiple sensors

Same load can be switched with multiple sensors if required.

Figure 3 shows two sensors switching one load.

Operation

The EYE 360° MINI RECESSED PIR SECURITY SENSOR is equipped with a high sensitivity PIR (Passive Infra-red) motion detector. A multi-cell technology Fresnel-style lens is used to divide the sensors basic detection range into multiple separate segments or zones. The sensor automatically scans for movement between zones, and then will activate connected devices such as security lighting as a result.

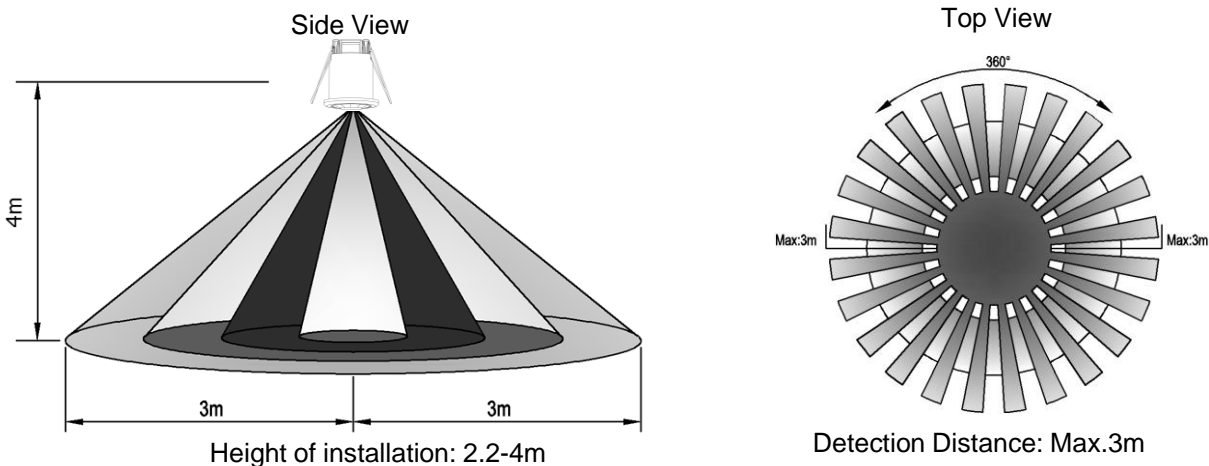

FIG 4 – Field of detection

The EYE 360° Sensor will provide optimal performance and range (3m radius) when installed in a ceiling approx 4m above the ground, as is shown in diagrams in FIG 8.

Sensor controls

TIME Duration: The length of time the sensor will activate a light or other load after detection can be adjusted from 10 seconds to 15 minutes. Rotating the TIME knob anti-clockwise will reduce the duration time.

LUX level: The EYE 360° MINI sensor has a built in photoelectric cell that automatically detects daylight and darkness levels. Rotating the LUX control knob anti-clockwise the sensor will only work at night. Rotating the LUX control knob towards (☀️), the sensor will work in both daylight and at night. Note: (☀️) setting is primarily used for testing the sensor after installation.

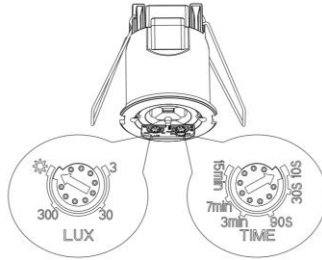

TIME Restarts function: After any subsequent detection the time restarts again from the beginning.

Manual Override

This sensor has Manual Override function which means that the light can stay permanently ON.

To turn the sensor into MANUAL MODE (in which it won't be affected by Time or LUX or Sensitivity settings) turn the wall switch 'OFF-ON, OFF-ON twice within 3 seconds. The light will stay 'ON' for maximum 8 hours. After 8 hours the sensor will automatically RESET itself back into 'AUTO MODE'.

To change back from MANUAL to AUTO MODE before expiry of 8 hours, turn the sensor 'OFF' for 30 seconds (or more) then switch it back 'ON'.

Note that switching the sensor OFF (either in MANUAL or AUTO MODE) over 30 sec then 'ON' again, the sensor will reset itself into WARM-UP period. Note that the "WARM-UP" period in this case may be less than 30 seconds.

Commissioning

1. Rotate the LUX knob fully clockwise for daylight operation (towards ☀️), set the TIME control to minimum (10s)
2. Turn 'ON' the power at the isolating switch. The load should turn on for a short period of time.
3. Wait 30 seconds for the circuit to stabilise.
4. Adjust the time control to the desired level.
5. Adjust the LUX control by rotating anti clockwise to revert to night time operation. If the lights are required to switch on earlier, e.g. dusk; wait for the desired light level, and slowly turn the LUX knob clockwise while someone walks across the centre of the detection area. When the lights switch on, release the LUX control knob.

Note: all passive infra-red detectors are more sensitive in cold and dry weather conditions rather than in warm and wet weather. The best performance of the sensor can be achieved when the movement is across the detection areas, not when is towards it or away from it.

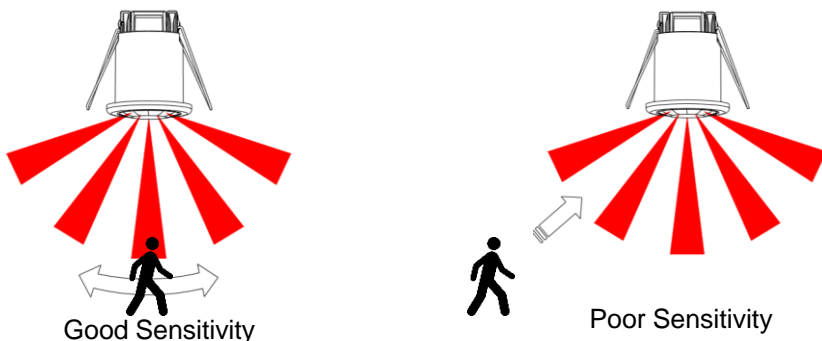

Troubleshooting

| PROBLEM | POSSIBLE REASON | POSSIBLE SOLUTION |
|---|---|---|
| Light does not switch ON when there is movement in the detection area | 1. No mains voltage | 1. Check all connections, fuses/switches |
| | 2. Nearby lighting is too bright. | 2. Redirect sensor or relocate the lamp |
| | 3. Sensor positioned in wrong direction | 3. Redirect sensor |
| | 4. Lux setting is too low | 4. Adjust LUX settings |
| Sensor will not operate during daylight. (Testing mode) | 1. No power 2. Sensor isn't set into daylight operation mode. | 1. First check that the power is turned 'ON'. Check connections, fuses, circuit breakers. 2. Check LUX control knob is fully set for 'DAY' operation (☀️). |
| Light switches ON for no apparent reason . False triggering | 1. Heat sources such as air-con, vents, heater flues, barbecues, other outside lighting, moving cars, activates the sensor. | 1. Redirect sensor away from those sources. |
| | 2. Dogs, cats, home animals possums, birds | 2. Adjust/Redirect/Relocate the sensor . |
| | 3. Wind and draughts activated the sensor. | 3. Cover sensor unit with a black cloth for a period of 5 min to check that the light does not trigger. Sometimes passages between buildings etc. can cause a "wind tunnel" effect. Adjust/Relocated the sensor. |
| | 4. Electromagnetic interference, from other electronic devices, ON /OFF switching of existing fluorescent, LED, lights etc. wired in the same circuit with sensor, may cause the sensor to trigger. For example a faulty wall switch or noisy fluorescent tubes/starters may activate the sensor. | a. Replace the faulty switch. b. Replace noisy fluorescent tubes and/or starters. c. Wire the sensor into its dedicated circuit. d. Relocate the sensor. |
| | 5. Reflection from swimming pool, or reflective surfaces (e.g. polished floors) or direct sunlight | 5. Redirect sensor from direct sunlight otherwise the photocell may get damaged. Redirect sensor. |
| Sensor not turning OFF Light remains ON | 1. The sensor is in 'Manual override mode'. 2. Continuous false triggering 3. Sensor is being activated again before the time duration has completed. | 1. Set the sensor into Auto Mode.(Turn sensor OFF for 2. 30 sec or more then switch it back ON) 3. Redirect/relocate the sensor to avoid false activation. Check for any extra sources of heat/air movement within detection area such as animals, moving objects. Adjust the sensor head and controls accordingly. |
| Sensor will not operate at night. | Ambient light is too high. | The level of ambient (street) light in the area may be too high. Increase LUX level control accordingly and remove any other sources of ambient light if possible. |
| Sensor switches ON during daylight. | 1. Low level of ambient light | 1. The level of ambient light in the area may be too dark to allow operation in Nighttime only mode. Re-adjust the LUX control accordingly. Redirecting the sensor may help |
| | 2. LUX control knob is set to daylight position. | 2. Check and adjust the LUX control knob to night operation |
| The detection distance becomes shorter | 1. The sensor lens is dirty | 1. Cleaning the LENS use soft cloth soaked with water, don't scratch the LENS. |
| | 2. Warm and wet environment | 2. Dry/clean the sensor |
| Sensor will not operate at all. | No power | Check that the power is switched ON at the circuit breaker or internal wall switch. Check that connections are not loose. |

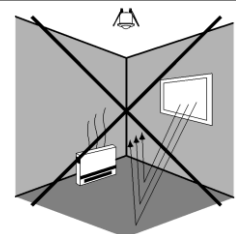
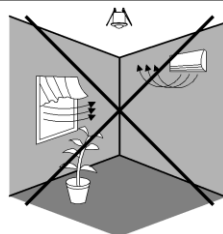
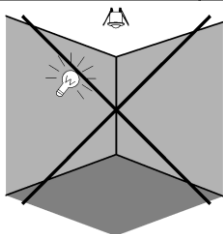



EYE 360 MINIPIR SENSOR SERIES II 21353

Important Note:

- Further adjustments may be required to maintain your security at ideal light level and sensitivity settings.
- When operating with standard lighting loads, ensure the lights are pointing away from the sensor head. Heat from globes may harm the sensor unit and can cause false re-triggering.
- To avoid dust build up and maintain proper performance, clean the sensor lens lightly with a damp cloth every 3 months.
- There are NO user serviceable parts inside.

Specifications

| | |
|----------------------------------|--|
| Model number: | 21357/05 -White |
| Voltage: | 240VAC, 50 Hz |
| Maximum Load [W] : | 800W, 3.3A max incandescent lamp 400W, 1.6A max. fluorescent lamp 200W, 0.8A max. LED lamp |
| Detection range: | 360°, Max: 3m |
| Duration Time: | (10±3) sec to (15±2) minutes adjustable . Warm up 30 sec |
| Lux level control: | Day & night or night only operation, <3-2000LUX (Adjustable) |
| Mounting Height: | 2.2m-4m |
| Cut-out size: | 40-45mm |
| Manual override: | Yes |
| Time restart: | Yes -Timer restarts after each detection |
| Max time in manual override mode | 8 hours, after resets into AUTO Mode automatically |
| Sensor power consumption | 0.5W |
| Detection Motion Speed: | 0.6-1.5m/s |
| Working Temperature: | -20~+40°C |

Warranty:

Brilliant Lighting warrants this product against defects in manufacture and workmanship for a period of 2 years from date of purchase. This warranty is only valid for products installed by a qualified electrical contractor and operated within the guidelines specified by Brilliant Lighting, and within the correct operating voltage ranges as stated on the product's rating label.

Warranty does not include damage or loss arising from incorrect installation, operation or maintenance of this product, damage caused through modification, incorrect installation, service by unqualified or unauthorised personnel or lack of regular maintenance and cleaning. Proof of installation by qualified personnel may be required, eg. Electrical Safety Certificate. Proof of purchase must be supplied with all warranty claims.

This warranty is provided in addition to any other rights and remedies of the customer under any law. In applications not intended for household, personal or domestic use, liability is limited to replacement or reimbursement of product only.

Our goods come with guarantees that cannot be excluded under the Australian Consumer Law. You are entitled to a replacement or refund for a major failure and compensation for any other reasonably foreseeable loss or damage. You are also entitled to have the goods repaired or replaced if goods fail to be of acceptable quality and the failure does not amount to a major failure.

Any claim under this warranty must be made within the specified warranty period from date of purchase of this product. To make a claim under the warranty, take the product (with proof of purchase – receipt or similar) to the store where you purchased the product or contact Brilliant Lighting at the address below.

This warranty is given by:

Brilliant Lighting (Aust)Pty. Ltd.
ABN 37 006 203 694
956 Stud Road Rowville, VIC 3178
Phone: 03 9765 2555
Email: warranty@brilliantlighting.com.au
MADE IN CHINA

WARRANTY REGISTRATION

Register your product, to ensure you protect your purchase with hassle free warranty and technical support. Ask our experts for advice and learn about new products before they are released.

Scan the QR code to register your product to be part of our Customer Care Program.

