



**GVX
SERIES AIRLINE
RESPIRATOR
USER MANUAL**



Supplied-Air Respirator: Type CE Continuous Flow

TC-19C-0489	F40 Series Adjustable Continuous Flow Control
TC-19C-0491	AC1000 Series Cooling Flow Control
TC-19C-0492	HC2400 Series Heating/Cooling Flow Control
TC-19C-0493	Frigitron2000 Series Cooling Flow Control
TC-19C-0494	DC5040 Series Cooling Flow Control
TC-19C-0498	F30 Series Fixed Continuous Flow Control

The Bullard GVX Series airline respirators are designed to provide respiratory protection in light- and heavy-duty abrasive blasting applications and general industry applications. The protective helmet meets ANSI Z89.1 Type 1, Class C requirements for head protection and ANSI Z87.1, Z87+ high-impact face protection. Capes are designed to protect the workers body from abrasive rebound. The respirator has been third party tested to provide 1,000 Assigned Protection Factor (APF) when used as instructed.

NOTE

For technical assistance or questions contact Bullard Customer Service at: Toll-Free 877-BULLARD (285-5273) or 859-234-6616
Online at www.bullard.com or e-mail info@bullard.com

Cautions and Limitations For GVX Series Supplied Air Respirators

- A. Not for use in atmospheres containing less than 19.5% oxygen.
- B. Not for use in atmospheres immediately dangerous to life or health (IDLH). IDLH is defined in 29 CFR 1910.134(b).
- C. Do not exceed maximum use concentrations established by regulatory standards.
- D. Airline respirators can be used only when respirators are supplied with respirable air meeting the requirements of CGA G-7.1 Grade D or higher quality.
- E. Use only the pressure ranges and hose lengths specified in this User Manual.
- J. Failure to properly use and maintain this product could result in injury or death.
- M. All approved respirators shall be selected, fitted, used, and maintained in accordance with MSHA, OSHA, and other applicable regulations.
- N. Never substitute, modify, add, or omit parts. Use only exact replacement parts in the configuration as specified by the manufacturer.
- O. Refer to user's instructions, and/or maintenance manuals for information on use and maintenance of these respirators.
- S. Special or Critical User's Instructions and/or specific use limitations apply. Refer to User's Instructions before donning.



Table of Contents

Introduction	2-3
NIOSH Approval Labels	
F30 Series Flow Control Devices.....	4
F40 Series Flow Control Devices.....	5
AC1000 Series Flow Control Devices	6
HC2400 Series Flow Control Devices.....	7
Frigitron 2000 Series Flow Control Devices	8
DC50 Series Flow Control Devices.....	9
Component Concept	10
Breathing Air Pressure Table	11
Air Source/Respirator Configurations	12
Respirator Assembly	
Sizing the Headband	13
Installing Headband into Inner Shell	14
Attaching Cape to Helmet.....	14
Installing Breathing Tube Assembly into Respirator Helmet.....	14
Using Climate Control Devices	14
Installing Lenses.....	15
Respirator Use	
Donning	16
Doffing.....	16
Inspection, Cleaning, and Storage	
Cape	17
Headband and Chin Strap.....	17
Helmet.....	17
Lenses and Window Frame Gasket.....	17
Breathing Tube Assembly	18
Air Supply Hoses.....	18
Cheek Pads	18
Storage.....	18
Parts and Accessories	19-21
AC1000 Cool Climate Control Tube	22
HC2400 Hot/Cold Climate Control Tube	23-24
DC50 Series Dual-Cool Climate Control Tube/ DC70 Vest	25-26
Frigitron 2000 Cool Climate Control Tube	27
V10 Breathing Air Supply Hose	28-29
Warranty	30
Return Authorizations	30



- 1) Read all warnings and instructions prior to using this respirator. Improper respirator use may result in serious injury and/or death. Improper use may also cause certain life threatening delayed lung diseases such as silicosis, pneumoconiosis, or asbestosis. Respirators shall be selected, fitted, used and maintained in accordance with MSHA, OSHA, NIOSH and other applicable regulations.
- 2) Do not use this respirator if any of the following conditions exist:
 - The atmosphere is immediately dangerous to life or health (IDLH) as defined in 21 CFR 1910.134(b).
 - You cannot escape without the aid of the respirator
 - The atmosphere contains less than 19.5% oxygen
 - The work area is poorly ventilated
 - Unknown contaminants are present
 - Contaminant concentrations are unknown or in excess of maximum use concentrations for this respirator.
- 3) Leave the work area immediately if:
 - Any respirator component becomes damaged
 - Airflow into respirator stops or slows down
 - The air pressure, as indicated on the gauge, drops below the minimum specified in the Breathing Air Pressure Table in the GVX Series User Manual
 - Breathing becomes difficult
 - You become dizzy, nauseous, too hot, too cold, or ill
 - You taste, smell, or see contaminants inside the respirator hood
 - Your vision becomes impaired
- 4) Always leave the contaminated area before reaching into the helmet or doffing the respirator.
- 5) It is imperative to know the level of concentration of contaminants for which this respirator, or any respirator, is being used in order to select an appropriate respirator. If this respirator is used in sandblasting, it is necessary to regularly monitor the concentrations outside the respirator during the blasting operations.
- 6) It is imperative to measure the concentration of the contaminants after the blasting stops before reentering the area. Concentrations may still be high enough to exceed the maximum use concentrations of many respirators, including supplied air respirators.
- 7) Do not assume that the concentrations you measured at an earlier time or location are the same for a different task or operation. Concentrations may vary significantly depending on factors including, but not limited to, the number of blasters engaged in the operation, whether the blasting is in an enclosed or partially-enclosed structure (confined or semi-confined space), whether ventilation is used, and the type of ventilation.
- 8) This respirator, when properly fitted and used, in conjunction with adherence to OSHA regulations and industry standards, will provide a reasonable degree of protection to the wearer. The respirator significantly reduces, but may not totally eliminate, the breathing of contaminants depending on the work practices involved. Where concentrations of contaminants exceed the protective rating of this respirator, a higher level of protection such as a self-contained breathing apparatus (SCBA) respirator may be required. Ideally, the employer should measure concentrations inside the breathing zone on a periodic basis to ensure that the wearer is receiving adequate protection.
- 9) Do not wear this respirator until you have passed a complete medical evaluation (perhaps including a lung x-ray) conducted by qualified medical personnel, and have been trained in the respirator's use, maintenance, and limitations by a qualified individual (appointed by your employer) who has extensive knowledge of Bullard GVX Series respirators.
- 10) Do not modify or alter this respirator in any manner. Use only GVX Series components and replacement parts manufactured by Bullard for use with this respirator. Failure to use Bullard components and replacement parts such as lenses, hoses, flow control devices, capes, and climate control devices, voids NIOSH approval of the entire respirator, invalidates all Bullard warranties, and could cause death, serious injury, lung disease, or exposure to other hazardous or life threatening conditions.

GVX Series Airline Respirator User Manual

- 11) Inspect all components of this respirator system daily for signs of wear, tear, or damage that might reduce the degree of protection originally provided. Immediately replace worn or damaged components with Bullard GVX Series components or remove the respirator from service.
- 12) This respirator must be supplied with clean breathable air at all times. The breathing air source at the point-of-attachment must provide at least Grade D breathable air as described in the Compressed Gas Association Commodity Specification CGA G-7.1 and as specified by Federal Law at 42 CFR, Part 84, Subpart J, 84.141(b) and 29 CFR 1910.134(i). The point-of-attachment is the point at which the air supply hose connects to the air source. This respirator does not purify air or filter out contaminants.
- 13) Do not connect the respirator's air supply hose to nitrogen, oxygen, toxic gases, inert gases, or other non-Grade D air sources. To prevent this, use airline couplings that are incompatible with outlets for other gas systems, as required by OSHA regulation 29 CFR 1910.134 (i) (8). Check the air source before using the respirator. Failure to connect to the proper air source could result in death or serious injury.
- 14) Use only the hose lengths and pressure ranges specified in the instruction manual. A pressure gauge attached to the air source is used to monitor the amount and adequacy of air provided to the respirator wearer.
- 15) Do not use this respirator in poorly ventilated areas or confined spaces such as tanks, small rooms, tunnels, or vessels unless the confined space is well ventilated and the contaminant concentrations are below the maximum use recommended for this respirator. In addition, follow all procedures for confined space entry, operation and exit as defined in applicable regulations and standards, including 29 CFR 1910.146.
- 16) Historically, the incidence of disease from overexposure to toxic substances almost always occurs because the OSHA regulations and industry standards applicable to the work practices involved are not followed. It is, therefore, imperative that the employer understand and follow all of these standards and regulations.

REMEMBER:

- Respiratory protection is but one component of safe work practices. To minimize the chances of overexposure, all safety regulations and standards must be followed; and,
- Respiratory protection is the last line of defense to be employed. The employer must first eliminate or minimize the levels of toxic substances in the work place by accepted engineering control measures. Assuming the employer and the wearer do their part, this respirator should provide the wearer with an adequate degree of protection.

GVX Series Airline Respirator User Manual

F40 Series Flow Control



E.D. BULLARD CO.
1898 Safety Way
CYNTHIANA, KY 41031 USA
877-BULLARD (285-5273)



MODEL GVX SERIES with F40 SERIES FLOW CONTROL DEVICES
TYPE CE CONTINUOUS FLOW SUPPLIED-AIR RESPIRATOR
THIS RESPIRATOR IS APPROVED ONLY IN THE FOLLOWING CONFIGURATIONS:

PROTECTION	MODEL	HOOD	ALTERNATE BREATHING TUBES	ALTERNATE CAPES	ALTERNATE FLOW CONTROL DEVICES	RESPIRATOR COMPONENTS ALTERNATE AIRLINE HOSES	ALTERNATE AIRLINE FITTINGS	ALTERNATE LENSES	ALTERNATE BELTS	ACCESSORIES	CAUTIONS AND LIMITATIONS
TC	GVX SERIES RESPIRATOR	GVX XXX	GVXBT GVXBT1 GVXBT2	30B1VX 30B2VX 30B3VX 30B4VX 30B5VX 30B6VX 30B7VX 30B8VX 30B9VX 30B10VX 30B11VX 30B12VX 30B13VX 30B14VX 30B15VX 30B16VX 30B17VX 30B18VX 30B19VX 30B20VX 30B21VX 30B22VX 30B23VX 30B24VX 30B25VX 30B26VX 30B27VX 30B28VX 30B29VX 30B30VX 30B31VX 30B32VX 30B33VX 30B34VX 30B35VX 30B36VX 30B37VX 30B38VX 30B39VX 30B40VX 30B41VX 30B42VX 30B43VX 30B44VX 30B45VX 30B46VX 30B47VX 30B48VX 30B49VX 30B50VX 30B51VX 30B52VX 30B53VX 30B54VX 30B55VX 30B56VX 30B57VX 30B58VX 30B59VX 30B60VX 30B61VX 30B62VX 30B63VX 30B64VX 30B65VX 30B66VX 30B67VX 30B68VX 30B69VX 30B70VX 30B71VX 30B72VX 30B73VX 30B74VX 30B75VX 30B76VX 30B77VX 30B78VX 30B79VX 30B80VX 30B81VX 30B82VX 30B83VX 30B84VX 30B85VX 30B86VX 30B87VX 30B88VX 30B89VX 30B90VX 30B91VX 30B92VX 30B93VX 30B94VX 30B95VX 30B96VX 30B97VX 30B98VX 30B99VX 30B100VX	FD1 FD2 FD3 FD4 FD5 FD6 FD7 FD8 FD9 FD10 FD11 FD12 FD13 FD14 FD15 FD16 FD17 FD18 FD19 FD20 FD21 FD22 FD23 FD24 FD25 FD26 FD27 FD28 FD29 FD30 FD31 FD32 FD33 FD34 FD35 FD36 FD37 FD38 FD39 FD40 FD41 FD42 FD43 FD44 FD45 FD46 FD47 FD48 FD49 FD50 FD51 FD52 FD53 FD54 FD55 FD56 FD57 FD58 FD59 FD60 FD61 FD62 FD63 FD64 FD65 FD66 FD67 FD68 FD69 FD70 FD71 FD72 FD73 FD74 FD75 FD76 FD77 FD78 FD79 FD80 FD81 FD82 FD83 FD84 FD85 FD86 FD87 FD88 FD89 FD90 FD91 FD92 FD93 FD94 FD95 FD96 FD97 FD98 FD99 FD100	AD1 AD2 AD3 AD4 AD5 AD6 AD7 AD8 AD9 AD10 AD11 AD12 AD13 AD14 AD15 AD16 AD17 AD18 AD19 AD20 AD21 AD22 AD23 AD24 AD25 AD26 AD27 AD28 AD29 AD30 AD31 AD32 AD33 AD34 AD35 AD36 AD37 AD38 AD39 AD40 AD41 AD42 AD43 AD44 AD45 AD46 AD47 AD48 AD49 AD50 AD51 AD52 AD53 AD54 AD55 AD56 AD57 AD58 AD59 AD60 AD61 AD62 AD63 AD64 AD65 AD66 AD67 AD68 AD69 AD70 AD71 AD72 AD73 AD74 AD75 AD76 AD77 AD78 AD79 AD80 AD81 AD82 AD83 AD84 AD85 AD86 AD87 AD88 AD89 AD90 AD91 AD92 AD93 AD94 AD95 AD96 AD97 AD98 AD99 AD100	AE1 AE2 AE3 AE4 AE5 AE6 AE7 AE8 AE9 AE10 AE11 AE12 AE13 AE14 AE15 AE16 AE17 AE18 AE19 AE20 AE21 AE22 AE23 AE24 AE25 AE26 AE27 AE28 AE29 AE30 AE31 AE32 AE33 AE34 AE35 AE36 AE37 AE38 AE39 AE40 AE41 AE42 AE43 AE44 AE45 AE46 AE47 AE48 AE49 AE50 AE51 AE52 AE53 AE54 AE55 AE56 AE57 AE58 AE59 AE60 AE61 AE62 AE63 AE64 AE65 AE66 AE67 AE68 AE69 AE70 AE71 AE72 AE73 AE74 AE75 AE76 AE77 AE78 AE79 AE80 AE81 AE82 AE83 AE84 AE85 AE86 AE87 AE88 AE89 AE90 AE91 AE92 AE93 AE94 AE95 AE96 AE97 AE98 AE99 AE100	AB1 AB2 AB3 AB4 AB5 AB6 AB7 AB8 AB9 AB10 AB11 AB12 AB13 AB14 AB15 AB16 AB17 AB18 AB19 AB20 AB21 AB22 AB23 AB24 AB25 AB26 AB27 AB28 AB29 AB30 AB31 AB32 AB33 AB34 AB35 AB36 AB37 AB38 AB39 AB40 AB41 AB42 AB43 AB44 AB45 AB46 AB47 AB48 AB49 AB50 AB51 AB52 AB53 AB54 AB55 AB56 AB57 AB58 AB59 AB60 AB61 AB62 AB63 AB64 AB65 AB66 AB67 AB68 AB69 AB70 AB71 AB72 AB73 AB74 AB75 AB76 AB77 AB78 AB79 AB80 AB81 AB82 AB83 AB84 AB85 AB86 AB87 AB88 AB89 AB90 AB91 AB92 AB93 AB94 AB95 AB96 AB97 AB98 AB99 AB100	AC1 AC2 AC3 AC4 AC5 AC6 AC7 AC8 AC9 AC10 AC11 AC12 AC13 AC14 AC15 AC16 AC17 AC18 AC19 AC20 AC21 AC22 AC23 AC24 AC25 AC26 AC27 AC28 AC29 AC30 AC31 AC32 AC33 AC34 AC35 AC36 AC37 AC38 AC39 AC40 AC41 AC42 AC43 AC44 AC45 AC46 AC47 AC48 AC49 AC50 AC51 AC52 AC53 AC54 AC55 AC56 AC57 AC58 AC59 AC60 AC61 AC62 AC63 AC64 AC65 AC66 AC67 AC68 AC69 AC70 AC71 AC72 AC73 AC74 AC75 AC76 AC77 AC78 AC79 AC80 AC81 AC82 AC83 AC84 AC85 AC86 AC87 AC88 AC89 AC90 AC91 AC92 AC93 AC94 AC95 AC96 AC97 AC98 AC99 AC100	AD1 AD2 AD3 AD4 AD5 AD6 AD7 AD8 AD9 AD10 AD11 AD12 AD13 AD14 AD15 AD16 AD17 AD18 AD19 AD20 AD21 AD22 AD23 AD24 AD25 AD26 AD27 AD28 AD29 AD30 AD31 AD32 AD33 AD34 AD35 AD36 AD37 AD38 AD39 AD40 AD41 AD42 AD43 AD44 AD45 AD46 AD47 AD48 AD49 AD50 AD51 AD52 AD53 AD54 AD55 AD56 AD57 AD58 AD59 AD60 AD61 AD62 AD63 AD64 AD65 AD66 AD67 AD68 AD69 AD70 AD71 AD72 AD73 AD74 AD75 AD76 AD77 AD78 AD79 AD80 AD81 AD82 AD83 AD84 AD85 AD86 AD87 AD88 AD89 AD90 AD91 AD92 AD93 AD94 AD95 AD96 AD97 AD98 AD99 AD100	

1. PROTECTION

- SB=Supplied-Air Abrasive Blast
- CF=Continuous Flow
- SA=Supplied-air

2. CAUTIONS AND LIMITATIONS

- A - Not for use in atmospheres containing less than 19.5 percent oxygen.
- B - Not for use in atmospheres immediately dangerous to life or health.
- C - Do not exceed maximum use concentrations established by regulatory standards.
- D - Air-line respirators can be used only when the respirators are supplied with respirable air meeting the requirements of CGA G-7.1 Grade D or higher quality.
- E - Use only the pressure ranges and hose lengths specified in the User's Instructions.
- J - Failure to properly use and maintain this product could result in injury or death.
- M - All approved respirators shall be selected, fitted, used and maintained in accordance with MSHA, OSHA and other applicable regulations.
- N - Never substitute, modify, add or omit parts. Use only exact replacement parts in the configuration specified by the manufacturer.
- O - Refer to User's Instructions, and/or maintenance manuals for information on use and maintenance of these respirators.
- S - Special or critical User's Instruction and / or specific use limitations apply. Refer to User Instructions before donning.

∞ Approval Label

E.D. BULLARD CO.
 1898 Safety Way
 CYNTHIANA, KY 41031 USA
 877-BULLARD (285-5273)



MODEL GVX SERIES with FRIGITRON 2000 SERIES FLOW CONTROL DEVICES

TYPE CE CONTINUOUS FLOW SUPPLIED-AIR RESPIRATOR

THIS RESPIRATOR IS APPROVED ONLY IN THE FOLLOWING CONFIGURATIONS:



Frigitron Series Flow Control

PROTECTION ¹	MODEL	RESPIRATOR COMPONENTS													CAUTIONS AND LIMITATIONS ²																																		
		ALTERNATE BREATHING TUBES	ALTERNATE CAPES													ALTERNATE AIRLINE HOSES	ALTERNATE BELTS	ACCESSORIES																															
TC-	GVX SERIES RESPIRATOR	GVXB	GVXBTS	88VXBTA	28VX	280RVX	46VX	4616VX	38VX	380RVX	13VX	1316VX	GVX	21821	21VX	PKXLVX	PKXLVX	36VX	36XLVX	FRIGITRON2000	FRIGITRON2000B	FRIGITRON2000S	V2050ST	V20100ST	GVXOLT	GVXOLG	GVXOLA40	GVXOL15	GVXLC	GVXPLC	36501	4612	GVXCS	20NC	GVXCP	GVXRCP	GVXRTRC	HEADSET-XXXX											
19C-0883	GVX	X	X	X	X	X	X	X	X	X	X	X	X	X	X	X	X	X	X	X	X	X	X	X	X	X	X	X	X	X	X	X	X	X	X	X	X	X	X	X	X	X	X	X	X	X	X	X	ABCDEIMNOS

1. PROTECTION

- CF= Continuous Flow
- SB=Supplied - Air Abrasive Blast
- SA=Supplied - Air

2. CAUTIONS AND LIMITATIONS

- A - Not for use in atmospheres containing less than 19.5 percent oxygen.
- B - Not for use in atmospheres immediately dangerous to life or health.
- C - Do not exceed maximum use concentrations established by regulatory standards.
- D - Air-line respirators can be used only when the respirators are supplied with respirable air meeting the requirements of CGA G-7.1 Grade D or higher quality.
- E - Use only the pressure ranges and hose lengths specified in the User's Instructions.
- J - Failure to properly use and maintain this product could result in injury or death.
- M - All approved respirators shall be selected, fitted, used and maintained in accordance with MSHA, OSHA and other applicable regulations.
- N - Never substitute, modify, add or omit parts. Use only exact replacement parts in the configuration specified by the manufacturer.
- O - Refer to User's Instructions, and/or maintenance manuals for information on use and maintenance of these respirators.
- S - Special or critical User's Instruction and / or specific use limitations apply. Refer to User Instructions before donning.

Component Concept

The Bullard GVX Series airline respirators consist of five components (Figure 1)

All components must be present and properly assembled to constitute a complete NIOSH approved respirator.

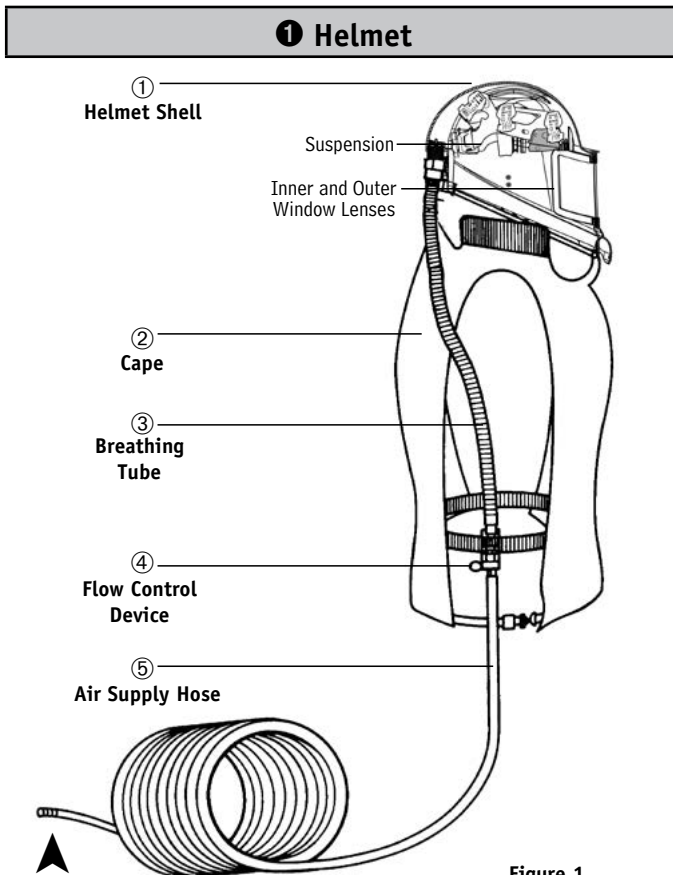

Figure 1

Supplying Grade "D" or Higher Air Quality

* See Parts & Accessories for all part numbers and product descriptions

④ Flow Control Devices*			
Without Climate Control		With Climate Control	
Constant F30 Series	Adjustable F40 Series	Cool Only AC1000 Frigitron DC5040	Heat/Cool HC2400

⑤ Air Supply Hose Series*	
High Pressure Compressed Air Source	Low Pressure Ambient Air Pump
V10 3/8" ID	V20 1/2" ID

Protection

HEAD: GVX series respirators meet ANSI Standard Z89.1 Type 1, Class C for protective headwear for industrial workers. The helmet is designed to provide limited head protection by reducing the force of falling objects striking the top of the head.

FACE: GVX Series respirators meet ANSI Standard Z87.1 (High Impact Z87+) for face protection. The use of both lenses provide limited face protection from flying particles, spray or hazardous liquids, but the lenses are not shatterproof.

EARS: GVX series respirators DO NOT provide hearing protection. Use properly fitted earmuffs, earplugs, and/or other hearing protection when exposed to high noise levels.

Air Quality

Respirable breathing (Grade D or better as defined by the Compressed Gas Association Specification G-7.1 as specified by Federal Law 42 CFR, Part 84, Subpart J, 84.141(b) and 29 CFR 1910.134(i)) must be supplied at the point of attachment of the air supply hose.

Air Source

Locate the source of supplied air whether it is a compressor or ambient air pump in a clean environment. Locate the air source far enough away from the work site to ensure the intake air remains contaminant free. Always use an inlet filter and as necessary suitable after cooler/dryers, filters, carbon monoxide monitors and alarms to assure clean breathable air at all times.

② Capes		
	With 3rd Hand Tab Assist	Without 3rd Hand Tab Assist
Poncho Style	28VX/38VX	46VX/13VX
"Golden Gate" Cap Sleeve	GGVX	21VX/21821
Long Sleeve Hibernia Parka	PKVX/PKXLVX	36VX/36XLVX

③ Breathing Tubes		
Standard	Short	88VX
GVXBT	GVXBTS	88VBTA

GVX Series Airline Respirator User Manual

Special or Critical User's Instructions

The GVX Series Breathing Air Pressure Table defines the air pressure ranges necessary to provide GVX Series respirators with a volume of air that falls within the required range of 6-15 cfm or 170-425 lpm (42 CFR, Part 84, Subpart J, 84.150).

⚠ WARNING

Failure to supply the minimum required pressure at the point-of-attachment for your hose length and GVX respirator type will reduce airflow and could result in death or serious injury.

To use the table and identify the proper air flow range; 1) select the air source (Compressed Air or Ambient/Free Air), 2) the use mode, 3) the exact part number of the flow control device; and 4) the length of the air supply hose. Note the maximum hose segments that are approved. Only use or select a configuration that is specified and has a pressure range provided.

GVX Series Respirator Breathing Air Pressure Table

		V10 Hose										
Air Source	Usage	Flow Control Device Part Number	Coupling Design	25' Max 1 Hose Length	50' Max 2 Hose Lengths	75' Max 3 Hose Lengths	100' Max 3 Hose Lengths	150' Max 3 Hose Lengths	200' Max 5 Hose Lengths	250' Max 5 Hose Lengths	300' Max 5 Hose Lengths	
Compressed Air	Constant Flow	F30/F30B/F30S	Ind. Interchange	17 - 29	19 - 32	21 - 36	24 - 37	27 - 43	30 - 47	33 - 52	35 - 56	
		F31	Schrader	14 - 27	17 - 30	19 - 33	22 - 35	25 - 41	29 - 45	32 - 50	34 - 54	
		F32/F33/F34*	Snap-Tite	12 - 21	14 - 25	17 - 29	20 - 31	23 - 37	27 - 42	31 - 47	32 - 51	
		F37	CEJN	8 - 14	12 - 19	14 - 24	17 - 26	21 - 33	25 - 38	29 - 44	31 - 48	
		F38	Bayonet	20 - 34	22 - 38	24 - 40	26 - 40	29 - 46	33 - 51	36 - 55	38 - 58	
	Adjustable Flow	F40/F40B/F40S	Ind. Interchange	22 - 33	25 - 36	26 - 39	28 - 40	31 - 46	34 - 50	37 - 54	38 - 58	
		F41	Schrader	22 - 32	25 - 37	26 - 39	28 - 40	31 - 45	35 - 50	37 - 54	39 - 57	
		F42/F43/F44*	Snap-Tite	21 - 29	23 - 33	25 - 36	27 - 37	30 - 42	33 - 47	34 - 51	38 - 55	
		F47	CEJN	18 - 25	21 - 29	23 - 32	25 - 34	28 - 40	31 - 45	34 - 49	36 - 53	
		F48	Bayonet	27 - 40	26 - 43	31 - 45	33 - 46	35 - 51	38 - 56	39 - 59	43 - 63	
	Cooling Mode	AC100030/AC100030B/AC100030S	Ind. Interchange	59 - 76	61 - 77	62 - 80	65 - 81	68 - 84	70 - 88	73 - 91	75 - 94	
		AC100031	Schrader	57 - 75	60 - 77	61 - 78	63 - 79	66 - 82	69 - 86	71 - 88	73 - 91	
		AC100032/AC100033/AC100034	Snap-Tite	56 - 73	58 - 75	59 - 76	61 - 77	64 - 80	68 - 83	70 - 86	72 - 90	
		AC100037	CEJN	54 - 70	56 - 80	57 - 73	59 - 76	61 - 78	66 - 81	68 - 84	70 - 88	
		AC100038	Bayonet	61 - 78	64 - 80	65 - 81	67 - 81	69 - 85	72 - 106	74 - 110	76 - 94	
		DC5040/DC5040B/DC5040S	Ind. Interchange	56 - 78	60 - 85	64 - 93	69 - 97	74 - 107	81 - 114	87 - 122	91 - 125	
		DC5041	Schrader	53 - 75	60 - 85	63 - 86	68 - 89	74 - 98	81 - 107	87 - 124	91 - 120	
		DC5042/DC5043/DC5044	Snap-Tite	47 - 68	53 - 75	57 - 80	62 - 82	69 - 92	78 - 101	84 - 109	88 - 116	
		DC5047	CEJN	41 - 59	46 - 67	52 - 73	57 - 76	64 - 86	72 - 95	80 - 103	84 - 111	
		DC5048	Bayonet	65 - 91	70 - 99	73 - 99	75 - 102	81 - 111	88 - 121	93 - 125	97 - 125	
		HC240030/HC240030B/HC240030S	Ind. Interchange	60 - 74	62 - 76	64 - 80	67 - 80	70 - 85	73 - 89	77 - 93	79 - 96	
		HC240031	Schrader	56 - 72	60 - 75	62 - 76	65 - 78	68 - 83	73 - 87	76 - 91	78 - 94	
		HC240032/HC240033/HC340034	Snap-Tite	57 - 71	59 - 73	61 - 75	64 - 77	68 - 81	72 - 86	76 - 89	79 - 94	
		HC240037	CEJN	55 - 70	58 - 72	60 - 74	63 - 76	67 - 80	72 - 85	74 - 89	77 - 93	
		HC240038	Bayonet	66 - 81	67 - 83	69 - 85	71 - 85	74 - 91	79 - 95	81 - 98	84 - 101	
	Heating Mode	HC240030/HC240030B/HC240030S	Ind. Interchange	68 - 84	69 - 85	70 - 88	73 - 89	76 - 94	80 - 96	84 - 101	86 - 106	
		HC240031	Schrader	64 - 81	68 - 84	69 - 85	72 - 88	75 - 92	80 - 97	83 - 100	86 - 103	
		HC240032/HC240033/HC340034	Snap-Tite	61 - 68	64 - 82	66 - 86	69 - 85	73 - 89	78 - 93	80 - 97	83 - 101	
		HC240037	CEJN	60 - 79	62 - 80	65 - 82	68 - 85	72 - 88	76 - 92	80 - 97	82 - 101	
		HC240038	Bayonet	72 - 90	73 - 92	75 - 93	77 - 95	80 - 99	85 - 104	89 - 107	91 - 110	

* 34/44 fittings not available for V5 Hose

		V20 Hose									
Air Source	Usage	Part Number	25'	50' Max 1 Hose Length	75'	100' Max 1 Hose Length	150'	200' Max 2 Hose Lengths	250'	300' Max 3 Hose Lengths	
Ambient Air	Constant Flow	F35/F35B/F35S	Ind. Interchange		7 - 12		8 - 15		10 - 19	13 - 21	
	Cooling	FRIGITRON2000/ FRIGITRON2000B/FRIGITRON2000S	Ind. Interchange		17 - 27		19 - 29		23 - 27	25 - 27	

Typical Breathing Air Source and Respirator Configurations

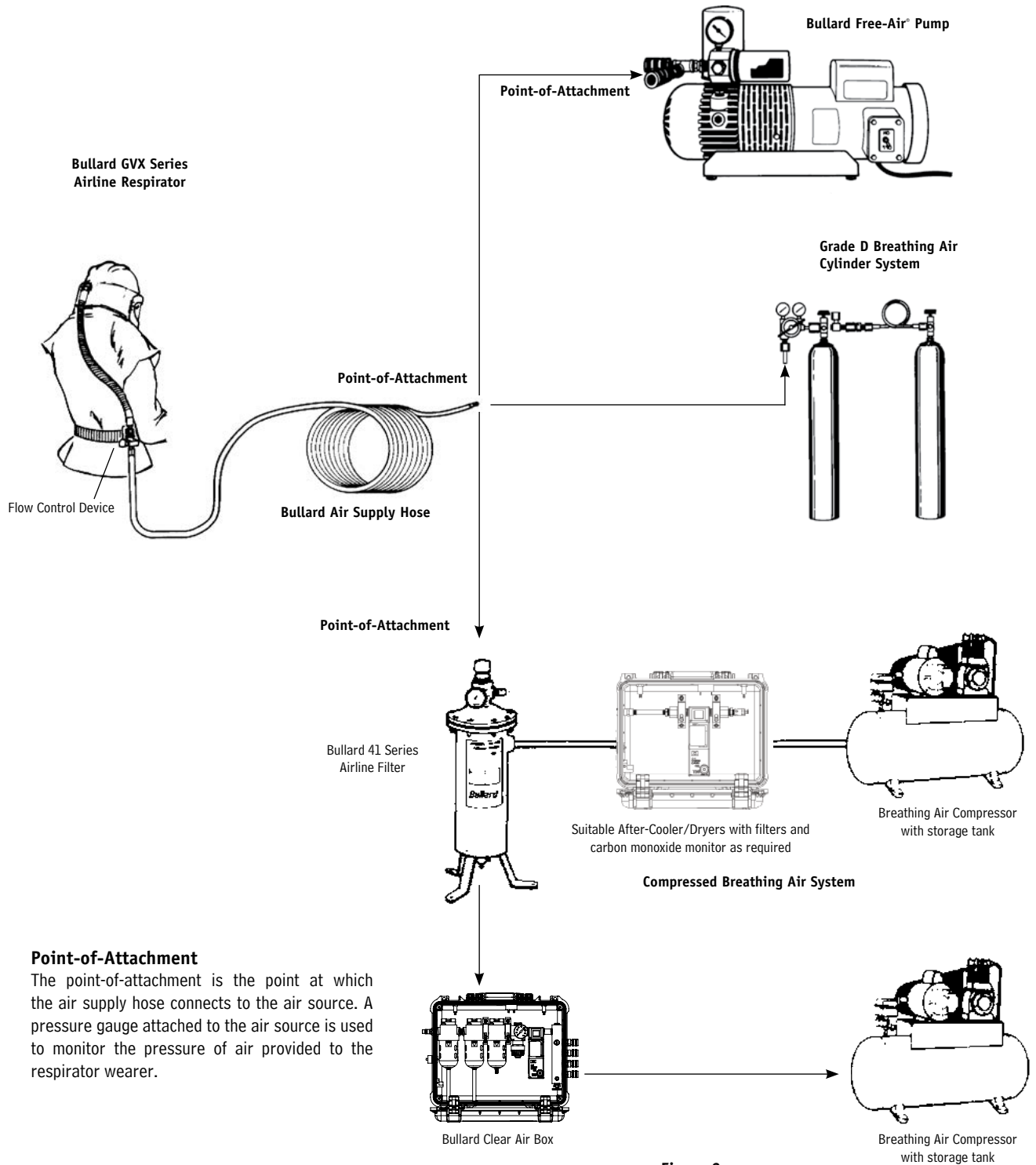

Figure 2

GVX Series Airline Respirator User Manual

Respirator Assembly

Before assembling this respirator, read the warning labels on the inside of the respirator cape and the helmet shell and this manual in full.

Remove and read the warning card inserted between the respirator's two lenses.

Sizing the Headband

Before you can size the headband suspension, the cape must be removed from the helmet using the following steps:

1. Open hinged window frame by lifting up on window latch.
2. Remove cape from helmet by lifting up on clamp and disengaging cape from helmet groove (Figure 3).
3. Adjust the suspension size: Flex-Gear® Ratchet-style suspension: Turn ratchet knob counter clockwise until headband opens to largest size. Place helmet on head and turn ratchet knob clockwise until it fits comfortably. DO NOT OVERTIGHTEN (Figure 4).
4. Remove from your head and replace the cape according to Bullard's instructions.

Adjust Crown Straps for Vertical Fit

To improve suspension comfort, adjust crown straps vertically by repositioning the crown strap posts in the crown straps. Vertical adjustment makes the headband ride higher or lower on the wearer's head. To adjust, push crown strap post from slot, move to new slot, and snap in to secure. Move key to desired vertical position. Repeat for other crown strap post (Figure 5).

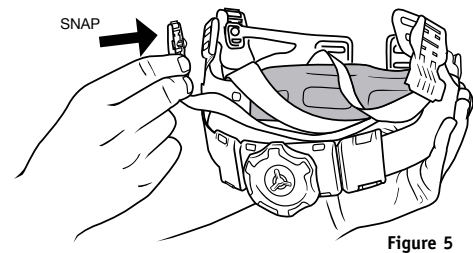
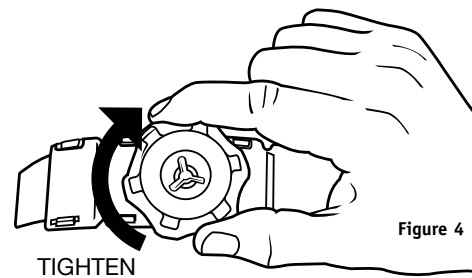
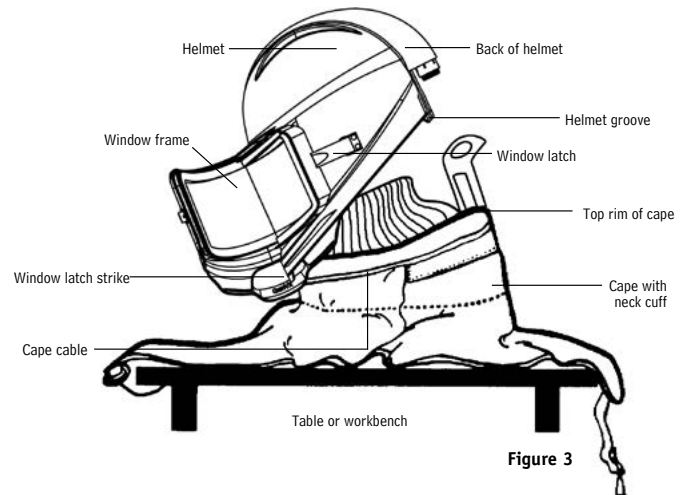

Installing Headband into Helmet

1. Turn helmet and headband suspension upside down.
2. Place headband inside helmet with brow pad facing front of shell.
3. Insert keys into respective key slots. Push firmly until keys snap into place (Figure 6).

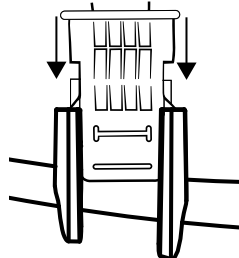

Figure 6

Using the GVXCS Chin Strap

1. Attach chin strap to headband by sliding chin strap keyway slot over plastic head on button inside the inner shell. Refer to GVXCS chin strap installation instructions.
2. Put helmet on your head. Adjust chin strap length with the plastic slide.

Optional Cheek Pad Assembly

1. Remove plastic from the Velcro attached to the cheek pad. Apply to the helmet. Press firmly, holding pad in place to ensure a secure placement (Figure 7).
2. Repeat steps for the opposite side.

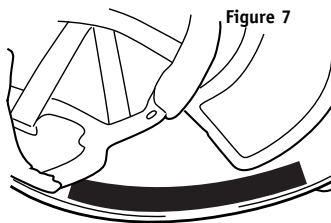

Figure 7

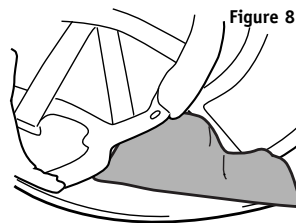

Figure 8

Attaching Cape to Helmet

1. Place cape on table or workbench.
2. With window frame open, place helmet on top of cape.
3. If cape has 3rd Hard tab assist, line up plastic tab on the cape over the breathing tube connection (Figure 9). Otherwise align clasp mechanism to front center of the helmet.

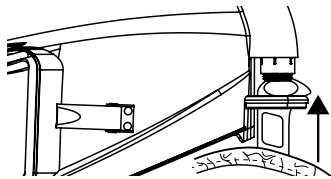

Figure 9

NOTE

Installation must begin with tab in the back of the helmet.

4. Ease cape rim completely into the groove along helmet edge, working your way to the front. Be certain cape is completely in place at every point along helmet's bottom edge.
5. Snap the clamp to tighten cable and hold cape snugly on helmet, while ensuring the cape stays in the groove. Latch should be centered in the front, below the chinguard (Figure 10).

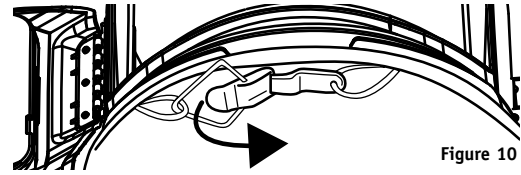

Figure 10

6. Close and latch window frame.
7. Pull quickly and forcefully on the cape to ensure proper assembly.

Installing Breathing Tube Assembly onto Respirator Helmet

1. Inspect each end of the breathing tube to ensure the red washers are installed inside the threaded fittings.
2. Connect breathing tube assembly to helmet by screwing plastic hose connector to fitting located on the rear of the helmet. Turn clockwise to tighten (Figure 11).

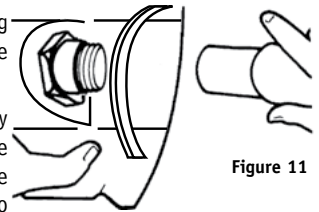

Figure 11

NOTE

If the red washer is missing or worn on the end of the breathing tube which connects to the flow control device, replace with GVXBTW before using.

Using Climate Control Devices as Flow Controls for GVX Series Supplied-Air Respirators

GVX Series Supplied-Air Respirators are approved for use by NIOSH with six optional Bullard climate control devices: AC1000 Series, HC2400 Series, DC5040 Series and Frigitron 2000 Series. These devices are considered flow controls, have belts for point-of-body attachment, and provide cool and/or warm air to the user.

1. Follow the instructions supplied with the climate control device.
2. Screw nylon hose connector on end of breathing tube to hose thread on climate control device.
3. Firmly tighten hose connector by hand (see Figure 12).
4. Lace belt and/or heat shield through belt loop bracket on climate control device.

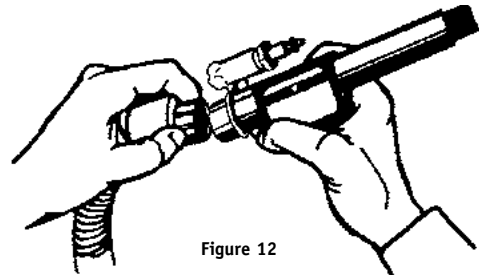

Figure 12

Replacing Inner Lenses

To replace the inner lens, first remove the old lens. Place helmet upside down in your lap. From the inside of the helmet, push the lens outward while pressing the black gasket with your other hand. Once loosened, remove the lens. Next, remove protective film from the new lens. With the helmet in your lap, align the lens in the corner of the gasket nearest the window hinge until it is secured. Work the lens into the gasket, adjusting the top and bottom placement evenly until it is completely attached (Figure 14).



Figure 14

Replacing the Outer Lens

With use, the outer lens may become abraded or worn. To replace the lens, first removed the old lens. Insert up to five 0.015" lenses or two 0.040" lens by sliding them into the upper and lower ledges on the inside of the door frame. If using the perforated tear away lenses, the pull tabs should be inserted so they can be grabbed from the outside of the helmet with the door latched closed. (Fig 15)

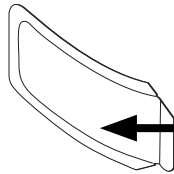

Figure 15

Using the 88VX Breathing Tube Adapter (Optional)

If upgrading from the Bullard 88VX respirator system to the GVX respirator system you can continue to use your supply of 88VX breathing tubes by attaching an 88BTA adapter to the helmet end of the 88VXBTA breathing tube to create an 88VXBTA breathing tube.

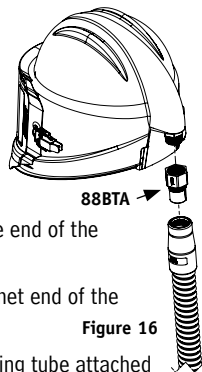

Figure 16

- 1) Ensure the rubber O-ring is in place on the male end of the adapter. Do not use without the O-ring.
- 2) Insert the male end of the adapter into the helmet end of the 88VXBTA breathing tube, hand tighten in place.
- 3) Align the female end of the adapter with breathing tube attached over the threaded breathing tube connection on the back of the GVX helmet and hand tighten (Fig 16).
- 4) To remove the breathing tube from the helmet or the adapter, reverse the steps above.

GVX Deluxe Suspension Padding (Optional)

The GVX respirator helmet's ratchet suspension can be used with padding options for additional wearer comfort. These pads are secured by an easy to install and remove hook and loop fastener system to allow washing, replacement and adjustments. The padding can be installed and removed with the suspension secured in place in the helmet or before installing the suspension in the helmet – illustrations are outside of the helmet for visual purposes only.

GVXRTCP Crown Pad (Fig 17)

- 1) Remove the brow pad from the suspension.
- 2) Align the crown pad with the low end centered to the ratchet handle and place into the suspension with the mesh side facing towards the users head.
- 3) Fold each ear-side flap over the suspension band and secure the fasteners to the outside material of the pad.
- 4) Fold the front-side flap over the suspension band and secure the fasteners to the outside material of the pad.

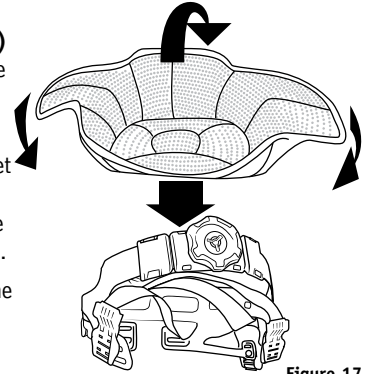

Figure 17

GVXRTRC Ratchet Cover (Fig 18)

- 1) Align the butterfly shaped pad on the inside of the suspension opposite of the ratchet handle.
- 2) Wrap the wing edges from the top and bottom over the suspension band adhering them together with the hook and loop fasteners.
- 3) The ratchet handle should still be accessible for easy adjustment.

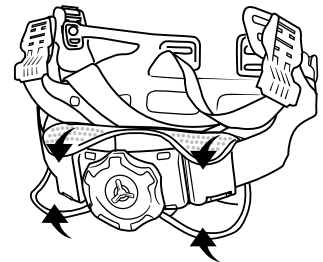

Figure 18

GVX Respirator Use

WARNING

Do not put on or remove this respirator in a hazardous atmosphere except for emergency escape purposes. Failure to follow this warning could result in death or serious injury.

Donning

Before using your GVX Series respirator, complete the assembly instructions given on pages 13-15. Before putting on respirator, make sure there is no dirt, dust, or contaminants inside the helmet.

1. Connect the Bullard air supply hose that is part of the NIOSH approved system to the air source supplying Grade D breathing air. Turn on the breathing air source.
2. With air flowing, connect breathing tube assembly to air supply hose. Connect quick-disconnect fitting on breathing tube assembly to quick-disconnect coupler on air supply hose. Once fitting is secured, release coupling sleeve to lock fittings together. Pull on both hoses to make sure they are attached securely.
3. Adjust air pressure at point-of-attachment to within the approved pressure range on the Breathing Air Pressure Table (Page 11) for approved pressure ranges.
4. With air still flowing, lower GVX Series respirator helmet onto your head for a comfortable fit.
5. Position headband for a comfortable fit. See instructions on page 4 for proper headband sizing.
6. Pull elastic chin strap under your chin and adjust for a secure and comfortable fit. The chin strap will help balance the helmet but is not required.
7. Be sure that the knitted inner neck cuff fits snugly around your neck to help provide a barrier to airborne contaminants.
8. With breathing tube assembly attached to the helmet, fasten belt around waist or hips and adjust for comfort.
9. Pull respirator cape around your body and secure sides by connecting the snap hooks. If using the Golden Gate cape, first secure the ties that connect in back, then in front. If using the Hibernia parka, tighten belt at waist.
10. Recheck air pressure and adjust if necessary.
11. With air still flowing into your respirator, you are now ready to enter work area.

NOTE

OSHA respirator regulations do not require fit testing of supplied air hoods and helmets.

Doffing

When finished working, leave work area wearing respirator and with air still flowing. Once outside contaminated area, remove respirator and then disconnect the air supply hose using the quick-disconnect fittings.

NOTE

If using V20 Series (1/2" I.D.) air supply hose, the quick-disconnect coupler does not have a shut-off valve. Therefore, air will continue to flow freely after disconnecting hose from respirator.

WARNING

Leave work area immediately if:

- Any respirator component becomes damaged.
- Airflow into respirator helmet stops or slows down.
- Air pressure gauge drops below the minimum specified in the Breathing Air Pressure Table (page 11).
- Breathing becomes difficult.
- You become dizzy, nauseous, too hot, too cold or ill.
- You taste, smell or see contaminants inside respirator helmet.
- Vision becomes impaired.

Failure to follow these instructions could result in death or serious injury.

WARNING

Do not leave respirator in work area. Respirable dust contaminants can remain suspended in the air for more than one hour after work activity ceases, even though you may not see them. Proper work practice requires you to wear the respirator until you are outside the contaminated area. Failure to don, doff and store the respirator outside of contaminated area could result in exposure to contaminants. Failure to follow these instructions could result in death or serious injury.

Inspection, Cleaning and Storage

Bullard's GVX Series respirators have a limited service life. Therefore, a regular inspection and replacement program must be conducted. Certain parts such as capes and lenses must be replaced frequently.

The GVX Series respirator and all component parts and assemblies should be inspected for damage or excessive wear, before and after each use, to ensure proper functioning. Immediately remove the respirator from service and replace parts or assemblies that show any sign of failure or excessive wear that might reduce the degree of protection originally provided. If you detect any of these signs, replace your cape immediately or remove the respirator from service. Inspect the inner neck cuff making sure that the band has retained sufficient elasticity.

Use only complete Bullard GVX Series components and replacement parts on this respirator. Refer to parts list for correct part numbers.

Since respirator use and the quality of maintenance performed vary with each job site, it is impossible to provide a specific time frame for respirator replacement. As a general guideline, the GVX Series respirator should be replaced after two years of service or less.

This respirator should be cleaned and sanitized at least weekly, or more often if subjected to heavy use. Respirators used by more than one person must be cleaned, inspected and sanitized after each use. If not cleaned, contamination may cause illness or disease.

REMEMBER, THE AIR YOU BREATHE WILL NOT BE CLEAN UNLESS THE RESPIRATOR YOU WEAR IS CLEAN.

WARNING

Do not use volatile solvents for cleaning this respirator or any parts and assemblies. Strong cleaning and disinfecting agents, and many solvents, can damage the plastic parts and reduce the protective properties of the respirator. Failure to heed these instructions may result in minor or moderate injury and/or equipment damage.

Cape

Inspection

Remove the cape from the respirator helmet and inspect it for rips, tears or damage from excessive wear that might reduce the degree of protection originally provided. If you detect any of these signs, replace your cape immediately or remove the respirator from service. Inspect the inner neck cuff making sure that the band has retained sufficient elasticity.

WARNING

Do not substitute any capes other than those manufactured by Bullard. Substituting other capes will void the NIOSH approval and could result in death or serious injury. In addition, Bullard capes have instructions and warnings sewn inside each for the benefit of the respirator user. Purchasing after-market "pirate" capes will deprive the respirator user to these important instructions and warnings.

Cleaning

Machine wash the cape in cold or warm water using a gentle cycle. Use a mild laundry detergent. Air-dry only. After cleaning, carefully inspect the cape once again for signs of damage.

Do not use volatile solvents to clean this respirator or any parts and assemblies. Strong cleaning and disinfecting agents, and many solvents, can damage the plastic parts.

Headband and Chin Strap

Inspection

Remove the headband suspension and chin strap from the inner shell. Inspect the headband for cracks, frayed or cut crown straps, torn headband or size adjustment slots, loss of pliability or other signs of excessive wear. Check the chin strap for loss of elasticity, cuts and cracked hanger clips.

If damage is detected, replace parts immediately with Bullard replacement parts or remove the respirator from service.

Cleaning

The headband suspension and chin strap should be hand-sponged with warm water and mild detergent, rinsed and air-dried. After cleaning and before reassembling, once again carefully inspect the parts for signs of damage.

Helmet

Inspection

Inspect the helmet for nicks, gouges, cracks, holes and any damage due to impact, rough treatment or wear.

If damage is detected, replace parts immediately with Bullard replacement parts or remove the respirator from service.

Cleaning

The helmet and window frame should be hand-sponged with warm water and mild detergent, rinsed and air-dried.

After cleaning and before reassembling, once again carefully inspect the helmet and parts for signs of damage.

Lenses and Window Frame Gasket

Inspection

Be sure the plastic inner lens fits securely in the window frame gasket. Remove any grit or dust from the gasket. Inspect the window frame gasket closely for cuts, wear or damage that will prevent a proper seal against the inner faceshield lens or the helmet window frame.

If damage is detected, replace parts immediately with Bullard replacement parts or remove the respirator from service.

Cleaning

To clean the lenses, hand-sponge with warm water and mild detergent, rinse and air-dry.

Breathing Tube Assembly

Inspection

Inspect the breathing tube for tears, cracks, holes, or excessive wear that might reduce the degree of protection originally provided. If any signs of excessive wear are present, replace the breathing tube immediately or remove the respirator from service.

Cleaning

To clean the breathing tube, hand-sponge with warm water and mild detergent, being careful not to get water inside. Rinse and air-dry. After cleaning, once again carefully inspect breathing tube for signs of damage.

CAUTION

Do not cut or remove foam that is inside the breathing tube. The foam helps reduce the noise level of the incoming air supply. It does not filter or purify your breathing air. NIOSH has approved this respirator with the foam in place. Failure to observe these instructions may result in minor or moderate injury.

Air Supply Hose

Inspection

The starter and extension hose(s) should be inspected closely for abrasions, corrosion, cuts, cracks and blistering. Be sure the hose fittings are crimped tightly to the hose so that air cannot escape. Make sure the hose has not been kinked or crushed by any equipment that may have rolled over it.

If any of the above signs are present or any other signs of excessive wear are detected, replace the air supply hose(s) immediately or remove the respirator from service.

Cleaning

The air supply hose(s) should be hand-sponged with warm water and mild detergent, rinsed and air-dried. Do not get water inside the air supply hose. After cleaning, once again carefully inspect air supply hose(s) for signs of damage.

Bullard air supply hose is not included in the purchase of respirator assembly and must be purchased separately. Bullard air supply hose must be used in order to maintain respirator assembly compliance.

WARNING

Only use hoses that are approved for use with this respirator. Other hoses could reduce airflow and protection, and expose the wearer to life threatening conditions. Failure to follow these instructions could result in death or serious injury.

Storage

All components are best stored dry, indoors at room temperature outside of the hazard area.

Helmet – It is best to store the helmet right-side up to prevent dust, dirt or other contaminants from settling into the helmet. Alternatively polybag or place in a clean storage container.

GVX Series Airline Respirator User Manual

Parts and Accessories for GVX Series Airline Respirators

GVX Series supplied-air respirators consist of five components: 1.) respirator helmet assembly, 2.) cape, 3.) breathing tube, 4.) flow control device, and 5.) air supply hose. There are options for some components to fit customer specifications. All components must be present and properly assembled, including a Bullard air supply hose, to constitute a complete NIOSH approved respirator.

CATALOG NUMBER	DESCRIPTION	CATALOG NUMBER	DESCRIPTION
GVX Bundles		Capes without Three Hand Tab Assist	
GVX2830	28" Cape Assembly with Continuous Flow Control	46VX	Tan Nylon Cape - 28" length
GVX2830AC1000	28" Cape Assembly with AC1000 Cool Tube	13VX	Tan Nylon Cape - 38" length
GVX2830HC2400	28" Cape Assembly with HC2400 Hot/Cold Tube	21VX/21821	Tan Nylon Cape, Golden Gate Style - 38" length
GVX2831AC1000	28" Cape Assembly with AC1000 Cool Tube, Schrader Fitting	36VX	Hibernia Parka - Tan Nylon Parka with sleeves - 38" length
GVX2835	28" Cape Assembly for use with Ambient Air Pump	36XLVX	Hibernia Parka - Tan Nylon Parka with sleeves - 38" length, extra-large
GVX2840	28" Cape Assembly with Adjustable Flow Control		
GVX3830	38" Cape Assembly with Continuous Flow Control	Standard Flow Controls & Belts (includes QD Nipple to Air Supply Hose and 4612 Nylon Belt)	
GVX3830AC1000	38" Cape Assembly with AC1000 Cool Tube	4612	Replacement 54" x 1 1/2" Nylon Belt (All Flow Controls)
GVX3830HC2400	38" Cape Assembly with HC2400 Hot/Cold Tube	36501	Replacement 54" x 1 1/2" Vinyl Decon Belt (All Flow Controls)
GVX3835	38" Cape Assembly for use with Ambient Air Pump	F30	1/4" Industrial Interchange Continuous Flow Control Fitting, Compressed Air
GVX3840	38" Parka Assembly with Adjustable Flow Control	F30B	1/4" Industrial Interchange Brass Continuous Flow Control Fitting, Compressed Air
GVXPK30AC1000	38" Parka Assembly with AC1000 Cool Tube	F30S	1/4" Industrial Interchange Stainless Steel Continuous Flow Control Fitting, Compressed Air
GVXPK30HC2400	38" Parka Assembly with HC2400 Hot/Cold Tube	F31	1/4" Schrader Continuous Flow Control Fitting, Compressed Air
GVXPK40	38" Cape Assembly with Adjustable Flow Control	F32	1/4" Snap-Tite Continuous Flow Control Fitting, Compressed Air
GVXGG30	38" Golden Gate with Cap Sleeves and Constant Flow Control	F33	1/4" Snap-Tite Brass, Continuous Flow Control Fitting, Compressed Air
Parts for GVX Series Respirators		F34	1/4" Snap-Tite Stainless Steel Continuous Flow Control Fitting, Compressed Air
GVXRT	Ratchet Suspension	F35	1/2" Industrial Interchange Continuous Flow Control Fitting, Free Air Pumps
GVXCS	Elastic Chin Strap	F35B	1/2" Industrial Interchange Brass Continuous Flow Control Fitting, Free Air Pumps
GVXCT	Breathing tube connector kit	F35S	1/2" Industrial Interchange Stainless Steel Continuous Flow Control Fitting, Free Air Pumps
GVXDMK	Door maintenance kit	F37	1/4" CEJN Continuous Flow Control Fitting, Compressed Air
GVXHP	Hinge pin	F38	1/4" Bayonet Continuous Flow Control Fitting, Compressed Air
GVXIG	Replacement inner gasket	F40	1/4" Industrial Interchange Adjustable Flow Control Fitting, Compressed Air
GVXFP	Replacement foam airline plug (10 pack)	F40B	1/4" Industrial Interchange Brass Adjustable Flow Control Fitting, Compressed Air
Accessories		F40S	1/4" Industrial Interchange Stainless Steel Adjustable Flow Control Fitting, Compressed Air
GVXCA	Carrying assembly	F41	1/4" Schrader Adjustable Flow Control Fitting, Compressed Air
GVXPL	Pinlock suspension	F42	1/4" Snap-Tite Adjustable Flow Brass Control Fitting, Compressed Air
RBPCOTTON	Cotton brow pad	F43	1/4" Snap-Tite Brass Adjustable Flow Stainless Steel Control Fitting, Compressed Air
RBPCOOL	Polartec® brow pad	F44	1/4" Snap-Tite Stainless Steel Adjustable Flow Control Fitting, Compressed Air
RBPVINYL	Vinyl brow pad	F47	1/4" CEJN Adjustable Flow Control Fitting, Compressed Air
GVXCP	Cheek pads	F48	1/4" Bayonet Adjustable Flow Control Fitting, Compressed Air
GVXRTCP	Suspension crown padding		
GVXRTRC	Ratchet cover padding		
Breathing Tubes			
GVXBT	Standard breathing tube 34"		
GVXBTS	Short breathing tube 27"		
88BTA	Breathing tube adaptor for 88VX breathing tube		
Lenses and Mylar Covers			
Inner Lenses			
GVXIL	Inner Tritan Lens, .040" thick (25/pkg)		
Outer Lenses			
GVXOL40	Outer PETG Lens, .040" thick (25/pkg)		
GVXOL15	Outer PETG Lens, .015" thick (50/pkg)		
BGVXOL40	Outer PETG Lens, .040" thick (200/bx)		
BGVXOL15	Outer PETG Lens, .015" thick (200/bx)		
GVXOLT	Outer Lenses, .030", pack of 25 Tinted (Smoke) Tritan®		
GVXOLG	Outer Lenses .042", pack of 25 Tinted (Green) Tritan®		
Lens Cover			
GVXLC	Mylar lens cover, adhesive-backed, 25 pk		
GVXPLC	Perforated tear away lenses, 25 pk		
Capes with Three Hand Tab Assist			
28VX	Tan Nylon Cape - 28" length		
38VX	Tan Nylon Cape - 38" length		
GGVX	Tan Nylon Cape, Golden Gate Style - 38" length		
PKVX	Hibernia Parka - Tan Nylon Parka with sleeves - 38" length		
PKXLVX	Hibernia Parka - Tan Nylon Parka with sleeves - 38" length, extra-large		

Heating/Cooling Flow Controls & Belts (includes QD Nipple to Air Supply Hose and 4612 Nylon Belt)
AC1000 Series – Cooling (Metal & Plastic), Compressed Air Only

- AC100030 1/4" Industrial Interchange Continuous Flow Control Fitting
- AC100030B 1/4" Industrial Interchange Brass Continuous Flow Control Fitting
- AC100030S 1/4" Industrial Interchange Stainless Steel Continuous Flow Control Fitting
- AC100031 1/4" Schrader Continuous Flow Control Fitting
- AC100032 1/4" Snap-Tite Continuous Flow Control Fitting
- AC100033 1/4" Snap-Tite Brass Continuous Flow Control Fitting
- AC100034 1/4" Snap-Tite Stainless Steel Continuous Flow Control Fitting

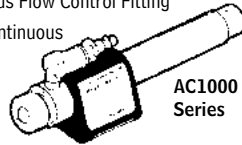
HC2400 Series (Metal and Plastic) - Cooling/Heating, Compressed Air (Includes 4612 Nylon Belt)

- HC240030 1/4" Industrial Interchange Continuous Flow Control Fitting
- HC240030B 1/4" Industrial Interchange Brass Continuous Flow Control Fitting
- HC240030S 1/4" Industrial Interchange Stainless Steel Continuous Flow Control Fitting
- HC240031 1/4" Schrader Continuous Flow Control Fitting
- HC240032 1/4" Snap-Tite, Continuous Flow Control Fitting
- HC240033 1/4" Snap-Tite Brass, Continuous Flow Control Fitting
- HC240034 1/4" Snap-Tite Stainless Steel Continuous Flow Control Fitting
- HC240037 1/4" CEJN Continuous Flow Control Fitting
- HC240038 1/4" Bayonet Continuous Flow Control Fitting

Heating/Cooling Flow Controls & Belts (includes QD Nipple to Air Supply Hose and 4612 Nylon Belt) cont.

- AC100037 1/4" CEJN Continuous Flow Control Fitting
- AC100038 1/4" Bayonet Continuous Flow Control Fitting coupler and male nipple

DC5040 Series – Cooling, Use with Cooling Vest, Compressed Air Only (Includes 4612 Nylon Belt)

- DC5040 1/4" Industrial Interchange Continuous Flow Control Fitting
- DC5040B 1/4" Industrial Interchange Brass Continuous Flow Control Fitting
- DC5040S 1/4" Industrial Interchange Stainless Steel Continuous Flow Control Fitting
- DC5041 1/4" Schrader Continuous Flow Control Fitting
- DC5042 1/4" Snap-Tite Continuous Flow Control Fitting
- DC5043 1/4" Snap-Tite Brass, Continuous Flow Control Fitting
- DC5044 1/4" Snap-Tite Stainless Steel Continuous Flow Control Fitting
- DC5047 1/4" CEJN Continuous Flow Control Fitting
- DC5048 1/4" Bayonet Continuous Flow Control Fitting
- DC70ML Cooling Vest DC70 M/L
- DC70LXXL Cooling Vest DC70 XL/XXL
- DC705X Cooling Vest DC70 only 5XL

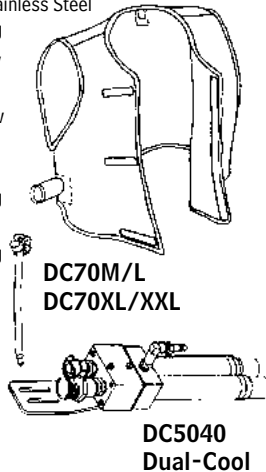
FRIGITRON 2000 Series, Cooling, Free Air Pumps (Includes 4612 Nylon Belt)

- FRIGITRON2000 1/2" Industrial Interchange Continuous Flow Control Fitting
- FRIGITRON2000B 1/2" Industrial Interchange Brass Continuous Flow Control Fitting
- FRIGITRON2000S 1/2" Industrial Interchange Stainless Steel Continuous Flow Control Fitting

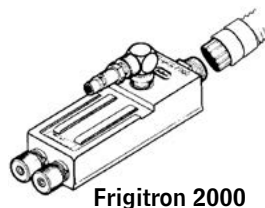

GVX Series Airline Respirator User Manual

V10 Series, 3/8" ID for Compressed Air – Starter Kit - Includes QD Coupler

<p>4696 V10 3/8" ID Starter Industrial Interchange 25' Black with V13 hose to pipe adapter and V17 nipple</p> <p>469650 V10 3/8" ID Starter Industrial Interchange 50' Black with V13 hose to pipe adapter and V17 nipple</p> <p>4696100 V10 3/8" ID Starter Industrial Interchange 100' Black with V13 hose to pipe adapter and V17 nipple</p> <p>46913 V10 3/8" ID Starter Schrader 25' Black with V13 hose to pipe adapter, no nipple</p> <p>46915 V10 3/8" ID Starter Snap-Tite 25' Black with V13 hose to pipe adapter, no nipple</p> <p>46916 V10 3/8" ID Starter Snap-Tite 25' Green, with V13 hose to pipe adapter, no nipple</p> <p>46917 V10 3/8" ID Starter Snap-Tite 50' Green, with V13 hose to pipe adapter, no nipple</p> <p>46918 V10 3/8" ID Starter Snap-Tite 25' Blue with S19443 Nipple</p> <p>46919 V10 3/8" ID Starter Snap-Tite 50' Blue with S19443 Nipple</p>	<p>S19443 QD Nipple 1/4" Snap-Tite, 1/4" Female NPT Brass (V12 Adapter Separate)</p> <p>V37 QD Coupler 1/4" CEJN 1/4" Female NPT (V12 Adapter Separate)</p> <p>3902 QD Nipple 1/4" CEJN 1/4" Female NPT (V12 Adapter Separate)</p> <p>V38 QD Coupler 1/4" Bayonet 1/4" Female NPT (V12 Adapter Separate)</p> <p>S19448 QD Nipple 1/4" Bayonet 1/4" Female NPT (V12 Adapter Separate)</p> <p>V11 Hose Adapter 3/8" to 3/8" Hose Brass</p> <p>V13 Hose Adapter 3/8" to 3/8" Pipe Brass</p> <p>V12 Hose Adapter 3/8" to 1/4" Pipe Brass</p>
--	--

Extension/Custom Assembly – No QD Coupler, Includes V13 hose to pipe adapter and V11 hose to hose adapter

<p>5454 V10 3/8" ID Extension 25' Black</p> <p>5457 V10 3/8" ID Extension 50' Black</p> <p>5458 V10 3/8" ID Extension 100' Black</p> <p>54514 V10 3/8" ID Extension 25' Blue</p> <p>54513 V10 3/8" ID Extension 50' Blue</p> <p>54512 V10 3/8" ID Extension 100' Blue</p> <p>54510 V10 3/8" ID Extension 25' Green</p> <p>54511 V10 3/8" ID Extension 50' Green</p> <p>54515 V10 3/8" ID Extension 100' Green</p>

V20 Series, 1/2" ID for Free Air Pumps – Includes QD Coupler and Nipple

<p>V2050ST V20 1/2" ID Starter Industrial Interchange 50' Black</p> <p>V20100ST V20 1/2" ID Starter Industrial Interchange 100' Black</p>

V10 Air Supply Hose Couplers, Nipples and Adapters

<p>V14 QD Coupler 1/4" Industrial Interchange, 1/4" Female NPT (V12 Adapter Separate)</p> <p>V27 QD Coupler 1/4" Industrial Interchange with V12 Adapter</p> <p>V17 QD Nipple 1/4" Industrial Interchange, 3/8" Female NPT (V12 Adapter Separate)</p> <p>V18 QD Coupler 1/4" Schrader, 1/4" Female NPT (V12 Adapter Separate)</p> <p>S19432 QD Nipple 1/4" Schrader, 1/4" Female NPT (V12 Adapter Separate)</p> <p>V19 QD Coupler 1/4" Snap-Tite 1/4" Female NPT (V12 Adapter Separate)</p> <p>V19B QD Coupler 1/4" Snap-Tite 1/4" Female NPT Brass (V12 Adapter Separate)</p> <p>S19442 QD Nipple 1/4" Snap-Tite, 1/4" Female NPT (V12 Adapter Separate)</p>

Replacement Parts & Accessories

<p>HS Heat Shield Assembly for Single Tube Assemblies, Leather</p> <p>HSDC Heat Shield Assembly for Dual Cool Assemblies, Leather</p>

For optional use with Bullard Airline Respirators

Includes: AC1000 Cool Tube, belt bracket, nylon belt and heat shield.

Function: The AC1000 is designed to supply a continuous flow of cool air to certain Bullard supplied air respirators.

⚠ WARNING

This climate control system is not recommended for cooling the air supply when the air temperature is less than 70°F (21°C). Since the system may cool the incoming air by more than 30°F (17°C), it is possible for ice to form in the breathing tube and reduce the airflow. Failure to observe this warning could result in death or serious injury.

Air Pressure

Continually monitor the air pressure at the point-of-attachment while operating the respirator. A reliable air pressure gauge must be present to monitor the pressure.

⚠ WARNING

Failure to supply the minimum required pressure at the point-of-attachment for your hose length will reduce airflow and could result in death or serious injury.

It is important to operate the Bullard climate control device in the prescribed pressure range for the particular Bullard respirator you are using. Refer to the user manuals' Breathing Air Pressure Table to determine the correct pressure that should be used with the climate control device.

Preparation and Use of the AC1000

1. In an uncontaminated atmosphere screw the hose connector fitting on the end of the breathing tube to the fitting on the AC1000. Tighten hose connectors firmly (**Figure 1**).

2. Lace the belt supplied with the Cool Tube through the belt bracket. Slots are provided for wearing the tube either vertically or horizontally on the waist. See Heat Shield instructions.

3. With the approved Bullard air supply hose connected to the air source and with air flowing into the hose, connect the quick-disconnect coupler on the air supply hose to the quick-disconnect nipple on the AC1000 Cool Tube.

4. Adjust the air pressure at the point-of-attachment to within the approved pressure range (**Figure 2**). See the Air Pressure Table on page 3.

5. Don the respirator by following the directions in your respirator instruction manual.

6. To obtain cooler air, turn the air temperature control knob counterclockwise (**Figure 1**).

Maximum cooling is attained when knob is fully open and when there is maximum airflow out of the AC1000 exhaust port.

To obtain air that is closer to ambient temperature, turn air temperature control knob clockwise. If knob is fully closed, your respirator will receive air at ambient temperature.

7. When finished working, leave the work area wearing the respirator. With the air still flowing into the hood, remove the hood and then disconnect the air supply hose using the quick-disconnect coupler attached to the AC1000 Cool Tube.

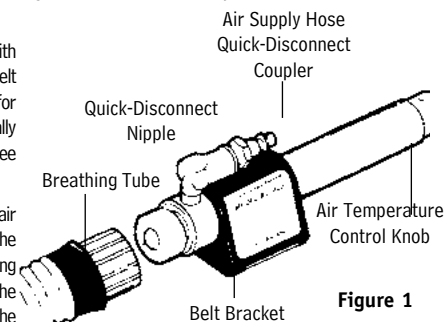

Figure 1

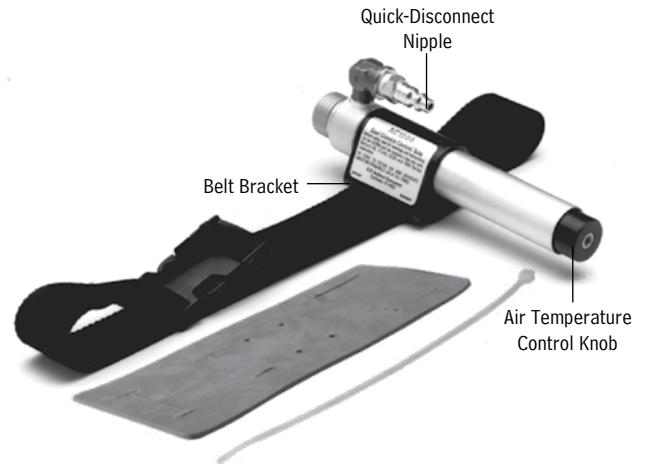
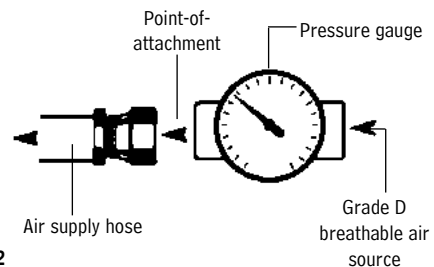

Figure 2



Heat Shield Instructions

Assembly

1. Determine whether the climate control device will be worn vertically or horizontally on the waist.
2. If the device will be worn in the horizontal position, align the tube on the heat shield as shown in **Figure 3**. If the tube will be worn in the vertical position, align the tube on the heat shield as shown in **Figure 4**.
3. Lace the belt supplied with your climate control device through both the heat shield slots and the climate control belt bracket slots.
4. Use plastic zip tie to secure the climate control unit to the heat shield.

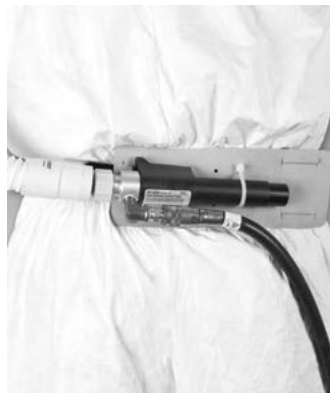

Figure 3



Figure 4

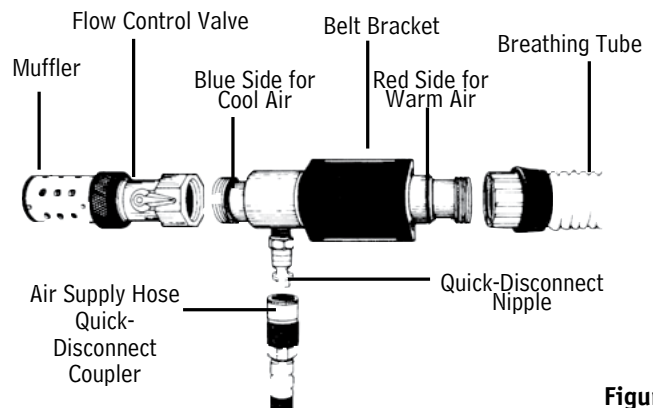

Figure 1

For optional use with Bullard Airline Respirators

Includes: Hot/Cold Tube, Flow Control Valve, Belt Bracket, Belt and Heat Shield

Function

The HC2400 is designed to supply a continuous flow of warm or cool air to certain Bullard Supplied-Air Respirators.



NOTE

HC2400 cannot be used with a low pressure air source such as an ambient air pump.

▲ WARNING

This climate control system is not recommended for cooling the air supply when the air temperature is less than 70°F (21°C). Since the system may cool the incoming air by more than 30°F (17°C), it is possible for ice to form in the breathing tube and reduce the airflow.

Failure to follow these instructions could result in death or serious injury.

Air Pressure

Continually monitor the air pressure at the point-of-attachment while operating the respirator. A reliable air pressure gauge must be present to monitor the pressure.

▲ WARNING

Failure to supply the minimum required pressure at the point-of-attachment for your hose length will reduce airflow and could result in death or serious injury.

It is important to operate the Bullard climate control device in the prescribed pressure range for the particular Bullard respirator you are using. Operating the correct pressure range will insure that the correct air flow is delivered to the respirator and will maintain the NIOSH approval. Refer to the user manuals' Breathing Air Pressure Table to determine the correct pressure that should be used with the climate control device.

Preparation and Use of the HC2400

1. For Warm Air:

- (a) In an uncontaminated atmosphere screw the nylon hose connector on the end of the breathing tube onto the RED side of the HC2400 Tube.
- (b) Screw the flow control valve and muffler onto the blue side of the HC2400 Tube (**Figure 1**). Tighten both connections firmly.

For Cool Air:

- (a) In an uncontaminated atmosphere screw the nylon hose connector on the end of the breathing tube on to the BLUE side of the HC2400 Tube.
- (b) Screw the flow control valve and muffler to the RED side. Tighten firmly.

▲ WARNING

For adequate air flow, attach the muffler and flow control valve to the end of the hot/cold tube that is opposite the breathing tube end.

Failure to observe this warning could result in death or serious injury.

DO NOT USE THE HC2400 WITHOUT THE MUFFLER AND FLOW CONTROL VALVE.

2. Lace the belt supplied with the HC2400 through the belt bracket. Slots are provided for wearing the tube either vertically or horizontally on the waist. See Heat Shield instructions below.
3. With the approved Bullard air supply hose connected to the air source and with air flowing into the hose, connect the quick-disconnect coupler on the air supply hose to the quick-disconnect nipple on the Hot/Cold Tube.
4. Adjust the air pressure at the point-of-attachment (**Figure 2**) to within the approved pressure range. See the Respirator Breathing Air Pressure table in the respirator user manual.
5. Put the hood on by following the directions in your respirator instruction manual. If you do not have instructions, contact Bullard Customer Service at the address or phone numbers below.
6. Turn flow control valve to adjust the flow and temperature of incoming air (**Figure 1**).

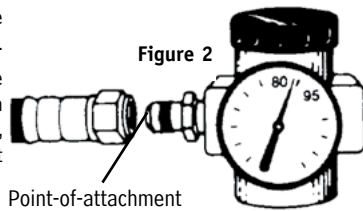

Figure 2

Point-of-attachment

Maximum cooling or warming is attained when knob is fully open and when there is maximum airflow out of the HC2400 exhaust port. To obtain air that is closer to ambient temperature, turn air temperature control knob counterclockwise. If knob is fully closed, your respirator will receive air at ambient temperature.

7. When finished working, leave the work area wearing the respirator. With the air still flowing into the hood, remove the hood and then disconnect the air supply hose using the quick-disconnect coupler attached to the Hot/Cold Tube.

Heat Shield Instructions

Assembly

1. Determine whether the climate control device will be worn vertically or horizontally on the waist.
2. If the device will be worn in the horizontal position, align the tube on the heat shield as shown in **Figure 3**. If the tube will be worn in the vertical position, align the tube on the heat shield as shown in **Figure 4**.
3. Lace the belt supplied with your climate control device through both the heat shield slots and the climate control belt bracket slots.

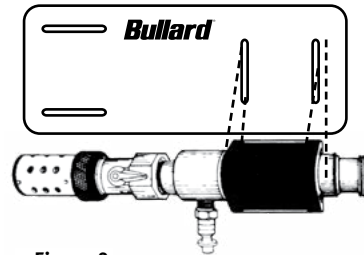

Figure 3

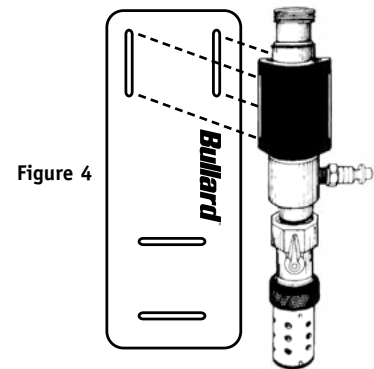

Figure 4

For optional use with Bullard Airline Respirators



The DC50 Dual-Cool tube is designed to supply a continuous flow of cool air to certain Bullard supplied air respirators and body vests. The DC50 Dual-Cool tube cannot be used with a low pressure air source such as an ambient air pump.

Air Pressure

Breathing air pressure must be continually monitored at the point-of-attachment while operating the respirator. A reliable air pressure gauge must be present to monitor the pressure during respirator operation.

⚠ WARNING

Failure to supply the minimum required pressure at the point-of-attachment for your hose length and type will reduce airflow and could result in death or serious injury.

The Breathing Air Pressure Table in the user manual defines the air pressure ranges necessary to provide the respirator with a volume of air that falls within the required range of 6-15 cubic feet per minute (cfm) or 170-425 liters per minute (lpm). (See 42 CFR, Part 84, Subpart J, 84.150)

⚠ WARNING

The DC50 Dual-Cool climate control system is not recommended for cooling the air supply when the air temperature is less than 70°F (21°C). Because the DC50 Dual-Cool may cool the incoming air by more than 30°F (17°C), it is possible for ice to form in the breathing tube and reduce the airflow. Failure to observe these warnings could result in death or serious injury.

Assembly and Use

Assembly must be conducted in an uncontaminated atmosphere.

Assembling the Cooling Vest

1. Insert the muffler end of the cooling vest connector hose well into the air entry sleeve of the vest (**Figure 1**).

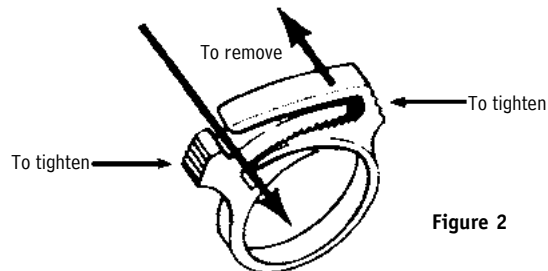
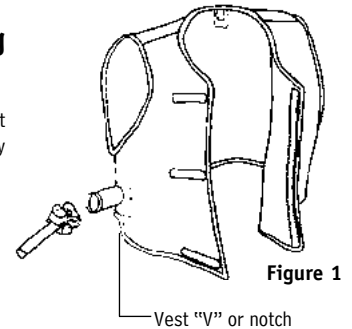

Head Shield Assembly Instructions

The HSDC climate control heat shield is designed to work with the Bullard DC50 Dual-Cool climate control device.

Assembly

1. Lace the belt supplied with your climate control device through both the heat shield slots and the climate control belt bracket slots.
2. Use plastic zip ties (2 included) to secure the climate control to the heat shield. **(Figure 3)**

Donning the Dual-Cool Tube and Cooling Vest

1. Screw the hose connector that is on the end of the breathing tube to threaded connector on Dual-Cool. Lace the belt through the slots in the belt bracket **(Figure 3)**.

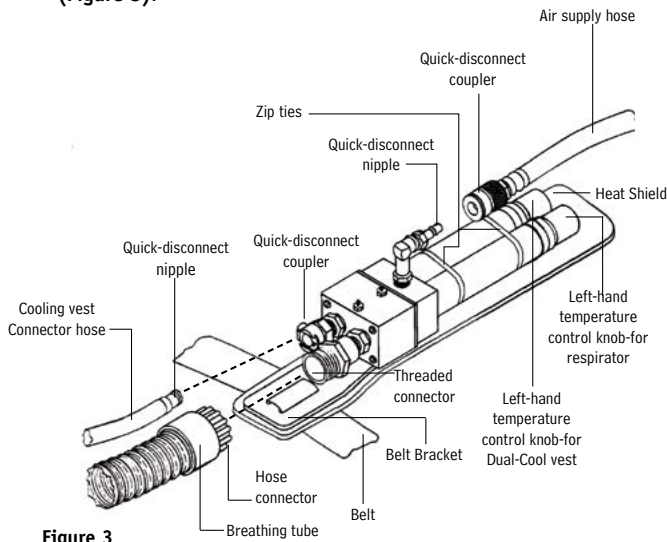

Figure 3

2. Don the belt, belt bracket, and Dual-Cool. Adjust belt comfortably, but loosely, around your waist, insuring that the Dual-Cool assembly is on your right-hand side.
3. Don the vest. Use the Velcro® closure strips to adjust loosely for size.

NOTE

The vest should mount over the belt with the Dual-Cool unit positioned in the "V" of the vest found on the right-hand side **(Figure 1)**.

4. Snap the quick-disconnect nipple found on the end of the cooling vest connector hose into the quick-disconnect coupler on the Dual-Cool **(Figure 3)**.
5. Don the respirator by following the directions in your respirator instruction manual. If you do not have instructions, contact Bullard Customer Service at the address or phone number given below.
6. With the approved Bullard air supply hose connected to the breathing air source, and with air flowing into the hose, connect the quick-disconnect coupler on the air supply hose to the quick-disconnect nipple on the Dual-Cool **(Figure 3)**.
7. Adjust the air pressure at the point-of-attachment to within the approved pressure range found in the respirator user manual **(Figure 4)**.

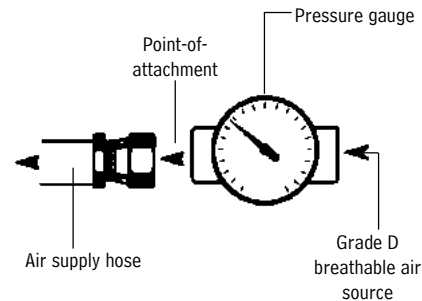

Figure 4

Operating the Dual-Cool Tube

1. To obtain cooler air, turn the air temperature control knobs counterclockwise **(Figure 3)**. Maximum cooling is obtained when knobs are open completely and when there is maximum airflow out of the Dual-Cool tube's exhaust ports. To obtain air that is closer to ambient temperature, turn air temperature control knobs clockwise. If knobs are closed completely, your respirator will receive air that is essentially at ambient temperature.

NOTE

There are separate controls to adjust the temperature of the air that is distributed to the vest and the breathing zone. The right-hand knob controls the air temperature to the respirator; the left-hand knob controls the air temperature to the cooling vest **(Figure 3)**.

2. When finished working, leave the work area wearing the respirator. With the air still flowing, remove the hood, and then disconnect the air supply hose using the quick-disconnect coupler attached to the Dual-Cool.

Cleaning

Machine wash the vest in warm water using a gentle cycle. Use a mild laundry detergent. Air-dry only. After cleaning, carefully inspect the vest for any signs of damage. If any damage is detected, remove the vest from service.

For optional use with Bullard Airline Respirators

INCLUDES: Frigitron 2000 and Belt

FUNCTION: The Frigitron 2000 is designed to supply a continuous flow of cool air as part of certain Bullard supplied air respirator systems.

NOTE:
Frigitron 2000 CAN be used with a low pressure air source such as Bullard ambient air pump Models ADP20, EDP30, and ICEPUMP11.

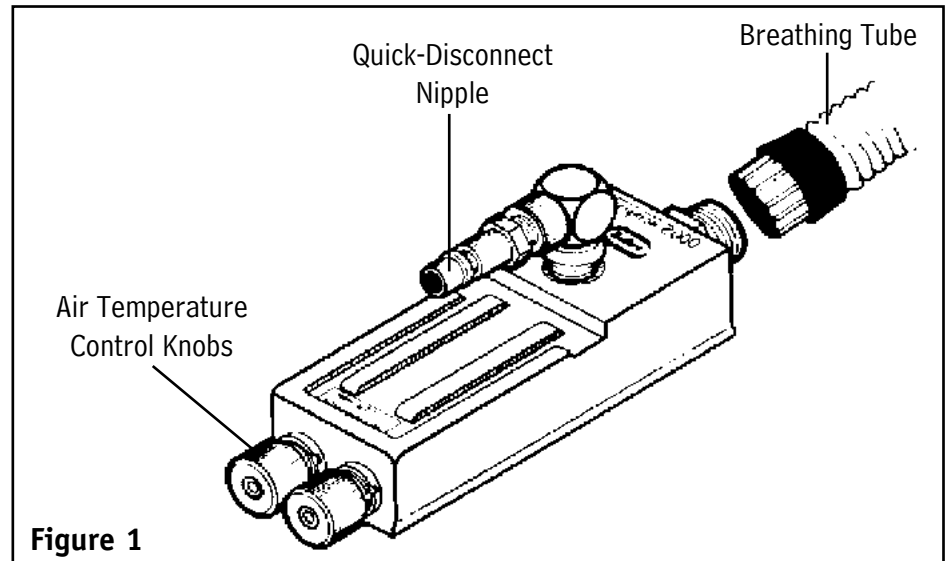

Figure 1

Air Pressure

Continually monitor the air pressure at the point-of-attachment while operating the respirator. A reliable air pressure gauge must be present to monitor the pressure.

▲ WARNING

Failure to supply the minimum required pressure at the point-of-attachment for your hose length will reduce airflow and may expose you to life threatening conditions, diseases or death.

The BREATHING AIR PRESSURE TABLE in the user manual defines the air pressure ranges necessary to provide the respirator with a volume of air that falls within the required range of 6-15 cubic feet per minute (cfm) or 170-425 liters per minute (lpm).

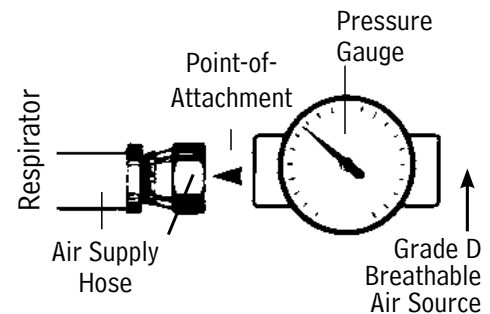

Figure 2

Preparation and Use of the Frigitron 2000

1. In an uncontaminated atmosphere, screw the end of the breathing tube to the fitting on the climate control device. Tighten hose connectors firmly.
2. Lace the belt supplied with the Cool Tube through the belt bracket.
3. With the approved Bullard V20 air supply hose connected to the air source and with air flowing into the hose, connect the quick-disconnect coupler on the air supply hose to the quick-disconnect nipple on the Frigitron 2000.
4. Adjust the air pressure at the point-of-attachment to within the approved pressure range (Figure 2).
5. Put the hood on by following the directions in your respirator instruction manual. If you do not have instructions, contact Bullard Customer Service at the address or phone numbers given below.
6. To obtain cooler air, turn either or both of the air temperature control knobs clockwise (Figure 1).

Maximum cooling is attained when either or both knobs are fully open and when there is maximum airflow out of the Frigitron exhaust ports.

To obtain air that is closer to ambient temperature, turn either or both air temperature control knob counterclockwise. If both knobs are fully closed, your respirator will receive air at ambient temperature.

7. When finished working, leave the work area wearing the respirator. With the air still flowing into the hood, remove the hood and then disconnect the air supply hose using the quick-disconnect coupler attached to the Frigitron 2000.

V10 Starter Hose Instructions

Starter hoses include female quick-disconnect coupler crimped on one end and V13 hose-to-pipe (3/8" NPT) adapter.

1. If the air source has a threaded attachment, use the supplied V13 hose-to-pipe (3/8" NPT) adapter to connect the threaded female fitting on the hose to the air source.
2. If the air source has a coupling attachment, refer to matching QD nipple specification and use either a V12 (1/4") or V13 (3/8") to connect the nipple to the hose (nipple and adapter may be included with certain part numbers). Attach QD nipple to QD coupling on the air source.
3. Connect the respirator's breathing tube fitting to the female quick-disconnect coupler on the V10 hose.

NOTE:

-  Threaded seal tape should be used on all threaded attachments. Beveled end of adapters are for hose side of connections.

V10 Extension Hose Instructions

Extension hoses allow you to add Bullard breathing air supply hose to your Bullard respirator's starter hose or another length of extension hose. For more information on maximum permissible hose lengths, configurations and necessary air pressure operating ranges, please refer to the User Manual Breathing Air Pressure Table. Extension hoses include V11 hose-to-hose adapter and V13 hose-to-pipe (3/8" NPT) adapter.

1. Remove any quick-disconnect nipple or adapter from the air source end of the starter hose and replace it with the V11 hose-to-hose adapter.
2. Connect one end of extension hose to the open end of the V11 adapter just inserted in the starter hose.
3. If the air source has a threaded attachment, use the supplied V13 hose-to-pipe (3/8" NPT) adapter to connect the threaded female fitting on the hose to the air source.

4. If the air source has a coupling attachment, refer to matching QD nipple specification and use either a V12 (1/4") or V13 (3/8") to connect the nipple to the hose. Attach QD nipple to QD coupling on the air source.

NOTE:

Threaded seal tape should be used on all threaded attachments. Beveled end of adapters are for hose side of connections.

Respirable Breathing Air

Respirable breathing air must be supplied to the point-of-attachment of the approved breathing air supply hose. Government regulations require that all breathing air meet the specifications for Grade D breathing air as described in Compressed Gas Association Commodity Specification G-7.1-1989 and specified by federal Law 30 CFR, Part II, Subpart J, 11.121(b).

WARNING

DO NOT connect your Bullard breathing air supply hose to nitrogen, toxic gases, inert gases, or other non-breathable, non-grade D air sources. Breathing air hose connection fittings must be incompatible with fittings for other industrial gases as described by the Compressed Gas Association.

Point-of-attachment

Air pressure at the point-of-attachment must be regulated with the ranges specified on your respirator's MSHA/NIOSH approval label.

NOTE:

You can repeat the extension hose connection steps using Bullard V10 hoses. However, do not exceed the lengths specified on the approval label or in the instruction manual for your specific respirator.

V10 Breathing Air Supply Hose and V10 Extension Hose Kit Assembly

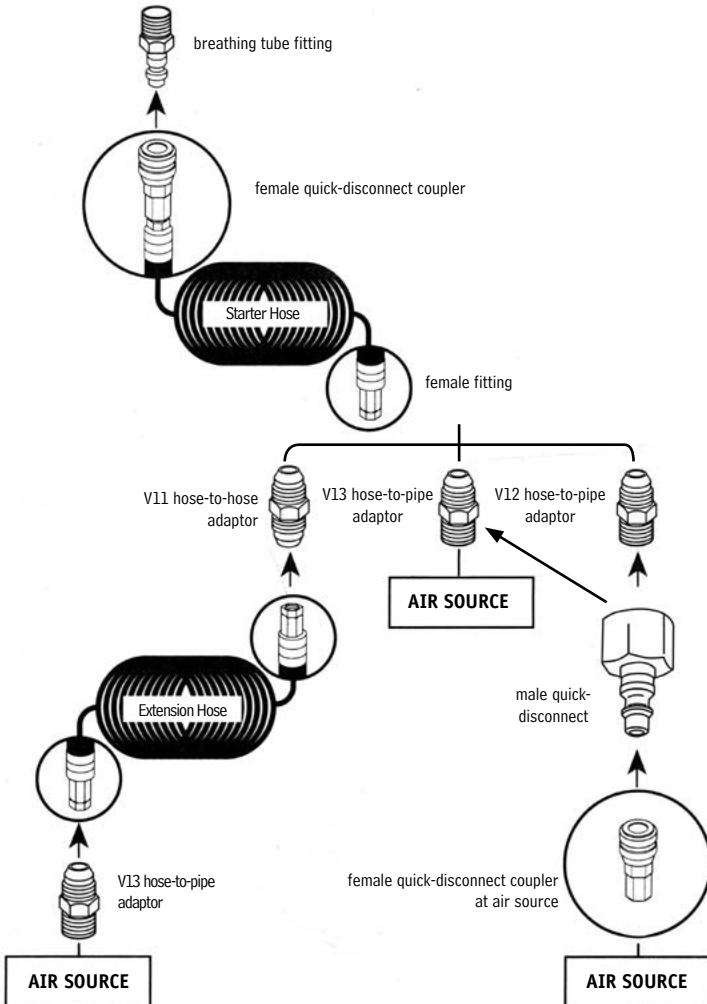

Bullard V20 Hose Kits

include one V20 rubber starter hose with female quick-disconnect coupler on one end and quick-disconnect nipple on the other.

Installation Instructions

1. Connect the respirator's breathing tube fitting to the female quick-disconnect coupler on the V20 hose.
2. Connect the quick-disconnect nipple on the hose to the point-of-attachment on your breathing air source.

Respirable Breathing Air

Respirable breathing air must be supplied to the point-of-attachment of the approved breathing air supply hose. Government regulations require that all breathing air meet the specifications for Grade D breathing air as described in Compressed Gas Association Commodity Specification G-7.1-1989 and specified by Federal Law 30 CFR, Part II Subpart J, 11.121(b).

Point-of-Attachment

Air pressure at the point-of-attachment must be regulated within the ranges specified on your respirator's NIOSH approval label.

V20 Breathing Air Supply Hose Assembly

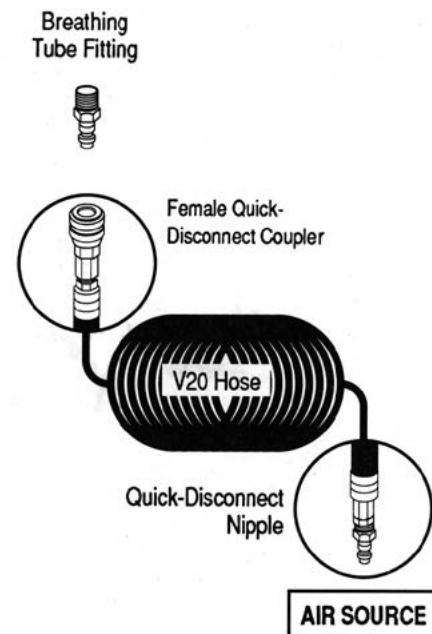

⚠ WARNING

Do not connect your Bullard breathing air supply hose to nitrogen, toxic gases, inert gases, or other non-breathable, non-grade D air sources. Breathing air hose connection fittings must be incompatible with fittings for other industrial gases as described by the Compressed Gas Association. Failure to observe this warning may result in death or serious injury.



Two Year Full Warranty

Bullard warrants to the original purchaser that the GVX Helmet shell and components will be free of defects in material and workmanship under normal use and service for a period of two (2) years from the date of purchase. All other consumable parts have a 1-year limited warranty against defects in material workmanship under normal use and service. Bullard's obligation under this warranty is limited to repairing or replacing, at its option, articles that are returned within the warranty period and that are, after examination, shown to Bullard's satisfaction to be defective, subject to the following limitations;

- a) GVX Respirator must be returned to the Bullard factory with shipping charges prepaid.
- b) GVX Respirator must not be altered from its original factory configuration.
- c) GVX Respirator must not have been misused, intentionally or negligently abused, or damaged in transport.
- d) A copy of the purchaser's original invoice showing the date of purchase is required to validate warranty coverage.

In no event shall Bullard be responsible for damages for loss of use or other indirect, incidental, consequential or special costs, expenses or damages incurred by the purchaser, notwithstanding that Bullard has been advised of the possibility of such damages.

ANY IMPLIED WARRANTIES, INCLUDING WARRANTIES OF MERCHANTABILITY AND FITNESS FOR A PARTICULAR PURPOSE, ARE LIMITED IN DURATION TO ONE (1) YEAR FROM THE DATE OF PURCHASE OF THIS PRODUCT.

Some states do not allow the exclusion or limitation of incidental or consequential damages, or allow limitations on how long an implied warranty lasts, so the above limitations or exclusion may not apply to you. This warranty gives you specific legal rights, and you may have other rights which vary from state to state.

Return Authorization

The following steps must be completed before Bullard will accept any returned goods. Please read carefully.

Follow the steps outlined below to return goods to Bullard for repair or replacement under warranty or for paid repairs:

1. Contact Bullard Sales Support by telephone or in writing at:

Bullard
1898 Safety Way
Cynthiana, KY 41031-9303
Toll-free: 877-BULLARD (285-5273)
Phone: 859-234-6616

In your correspondence or conversation with Sales Support, describe the problem as completely as possible. For your convenience, your sales support specialist will try to help you correct the problem over the phone.

2. Verify with your sales support specialist that the product should be returned to Bullard. Sales Support will provide you with written permission and a return authorization number as well as the labels you will need to return the product.
3. Before returning the product, decontaminate and clean it to remove any hazardous materials which may have settled on the product during use. Laws and/or regulations prohibit the shipment of hazardous or contaminated materials. Products suspected to be contaminated will be professionally discarded at the customer's expense.
4. Ship products to be returned, including those under warranty, with all transportation charges pre-paid. Bullard cannot accept returned goods on a freight collect basis.
5. Returned products will be inspected upon return to the Bullard facility. Bullard Sales Support will telephone you with a quote for required repair work which is not covered by warranty. If the cost of repairs exceeds stated quote by more than 20%, your sales support specialist will call you for authorization to complete repairs. After repairs are completed and the goods have been returned to you, Bullard will invoice you for actual work performed.

California Proposition 65 WARNING

Cancer and Reproductive Harm - www.P65Warnings.ca.gov.





Bullard Center
2421 Fortune Drive
Lexington, KY 40509 • USA
877-BULLARD (285-5273)
Tel: +1-859-234-6616
Fax: +1-859-246-0243

Americas Operations
1898 Safety Way
Cynthiana, KY 41031 • USA
877-BULLARD (285-5273)
Tel: +1-859-234-6616
Fax: +1-859-234-8987

Bullard GmbH
Dieselstrasse 8a
53424 Remagen • Germany
Tel: +49-2642 999980
Fax: +49-2642 9999829

Bullard AsiaPacific Pte. Ltd.
51 Changi Business Park Central 2
#03-04 The Signature
Singapore 486066
Tel: +65 6745 0556



©2021 Bullard. All rights reserved.
Bullard, Free-Air, Flex-Gear and Sure-Lock
are registered trademarks of Bullard.
Polartec is a registered trademark of
Polartec Fabrics.
Velcro is a registered trademark of
Velcro USA.



**Light.
Cool.
Comfortable.
Dependable.
Bullard.**



Bullard Center
2421 Fortune Drive
Lexington, KY 40509 • USA
877-BULLARD (285-5273)
Tel: +1-859-234-6616
Fax: +1-859-246-0243

Americas Operations
1898 Safety Way
Cynthiana, KY 41031 • USA
877-BULLARD (285-5273)
Tel: +1-859-234-6616
Fax: +1-859-234-8987

Bullard GmbH
Dieselstrasse 8a
53424 Remagen • Germany
Tel: +49-2642 999980
Fax: +49-2642 9999829

Bullard Asia-Pacific Pte. Ltd.
51 Changi Business Park Central 2
#03-04 The Signature
Singapore 486066
Tel: +65 6745 0556

www.bullard.com