

# PANES CLEAR GLASS TALL CABINET

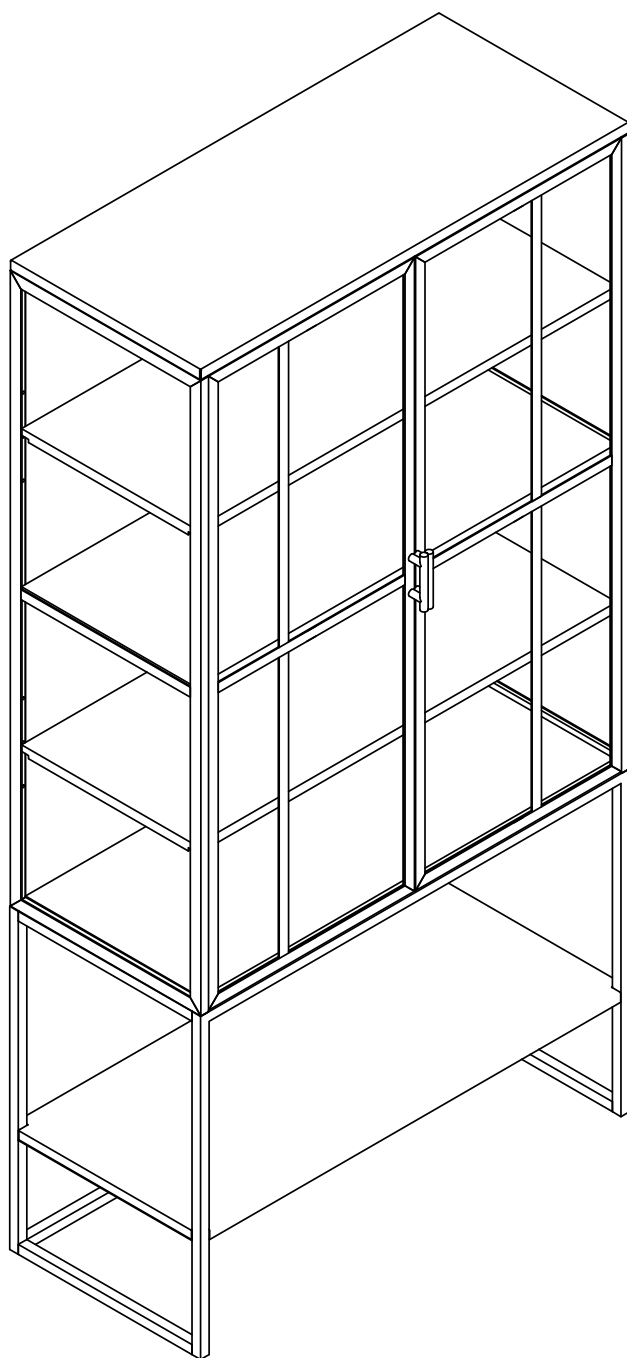

Assembly Instructions & Care Guide

CASTLERY

# Hello there.

We're so glad that our Castlery product has found a home with you. As proud makers of modern, quality furniture, we're confident that you will love and enjoy your purchase.

Setting it up is easy. Read on for a step-by-step guide to have your item assembled and ready for use.

Once you're done, consider sharing a photo on social media or leaving us a review. We'd love to see how you've styled it in your space.

**Thank you for being part of the Castlery community!**

---

## Contact us.

Should you have any questions or concerns regarding your purchase, you can contact us via [www.castlery.com/contact-us](https://www.castlery.com/contact-us).



[www.castlery.com](https://www.castlery.com)

# Before you start...

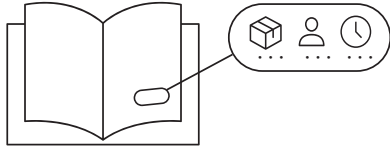

Check that you have received all cartons and familiarize yourself with the assembly requirements. This includes setting aside the allocated time required and having someone to assist you, if needed.

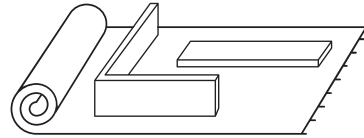

Ensure enough space for assembly. We recommend protecting your floor with a mat or cardboard to avoid scratches during the assembly process.

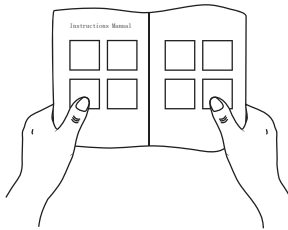

Read instructions carefully, and check that no parts are missing.

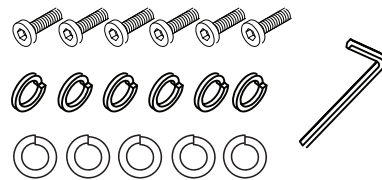

Lay out all hardware on a soft surface so you can easily identify them.

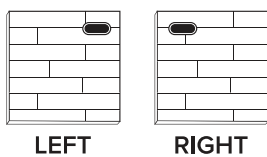

Carefully identify all components to differentiate which pieces are left and right.

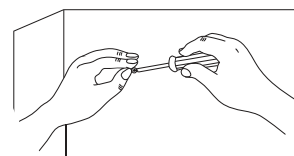

Carefully install your new product following the instructions stated. Don't skip ahead!

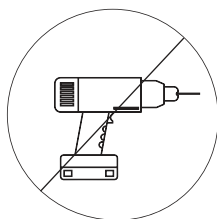

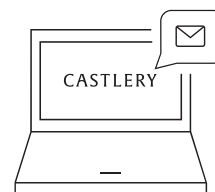

DO NOT over-tighten screws or use a drill. Only professional assemblers should use a drill.





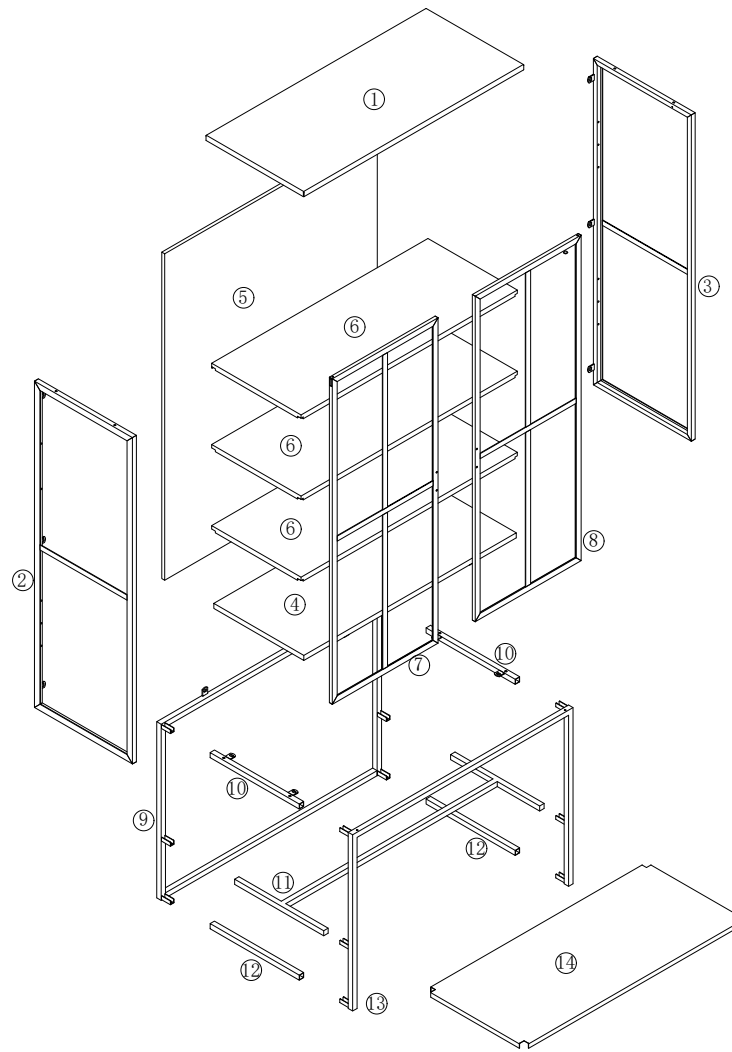

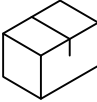
If you need further assistance, please contact us via [www.castlery.com/contact-us](http://www.castlery.com/contact-us).

# Overview



 x1     x2     45mins

- 
-  **IMPORTANT: 2 persons needed for assembly.** This will help to minimize potential damage to the product or injury to persons during assembly.
  -  There are inner box(es) that include components required to complete this assembly.
  -  Please do not completely tighten all the hardware, until each assembly step is complete.
  -  Before discarding the packaging, please use the checklist to ensure that you have all the parts required to assemble your product. Please kindly note if applicable please keep the original package when you want to return the product later.
  -  If parts are missing or damaged, we will gladly ship your replacements parts free of charge. Please contact us via [www.castlery.com/contact-us](http://www.castlery.com/contact-us). Illustrations in this guide are for reference only and may be slightly different from the actual object.

# Parts

BOX 1 OF 1

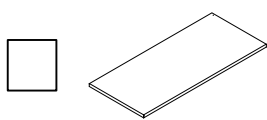

① TOP Panel  
**x1**

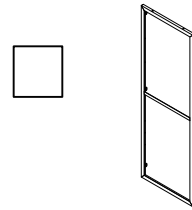

② Left Side Panel  
**x1**

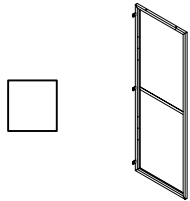

③ Right Side Panel  
**x1**

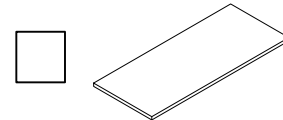

④ Bottom Panel  
**x1**

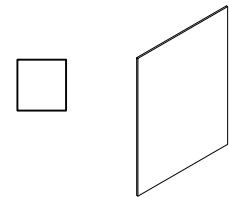

⑤ Back Panel  
**x1**

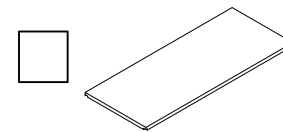

⑥ Adjustable Shelf  
**x3**

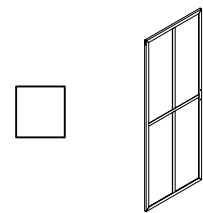

⑦ Left Door  
**x1**

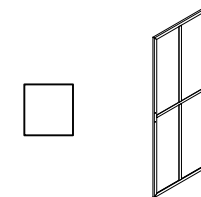

⑧ Right Door  
**x1**

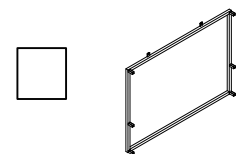

⑨ Rear Foot Frame  
**x1**

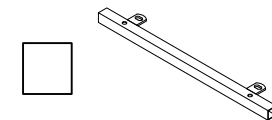

⑩ Connecting Rod  
**x2**

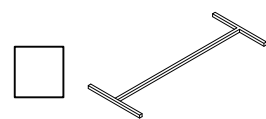

⑪ Connecting Fod  
**x1**

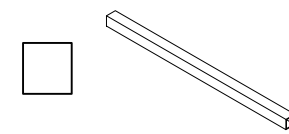

⑫ Connecting Fod  
**x2**

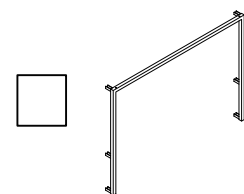



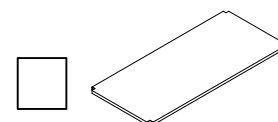







⑬ Front Foot Frame  
**x1**

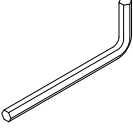
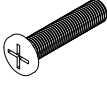

⑭ Lower Board  
**x1**

# Hardware

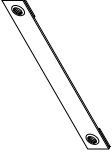
## BOX 1 OF 1

- |                          |   |                            |                          |  |                             |
|--------------------------|---|----------------------------|--------------------------|--|-----------------------------|
| <input type="checkbox"/> |    | Ⓐ Black Screw M6*10<br>x36 | <input type="checkbox"/> |     | Ⓑ Black Screw M6*12<br>x2   |
| <input type="checkbox"/> |    | Ⓒ Black Screw M6*25<br>x8  | <input type="checkbox"/> |     | Ⓓ Black Screw M4*8<br>x2    |
| <input type="checkbox"/> |    | Ⓔ Allen Key<br>4MM x1      | <input type="checkbox"/> |     | Ⓕ Black Screw M4*20<br>x4   |
| <input type="checkbox"/> |    | Ⓖ Handles<br>x2            | <input type="checkbox"/> |     | Ⓗ Door Axis<br>x2           |
| <input type="checkbox"/> |  | Ⓘ Hinge Washer<br>x2       | <input type="checkbox"/> |  | Ⓙ Anti-tipping Straps<br>x2 |
| <input type="checkbox"/> |  | Ⓚ Wall Anchors<br>x2       | <input type="checkbox"/> |   | Ⓛ Wall Screws<br>x2         |

*\*You will need a screwdriver (+/-) to complete this assembly.*

# Step 1

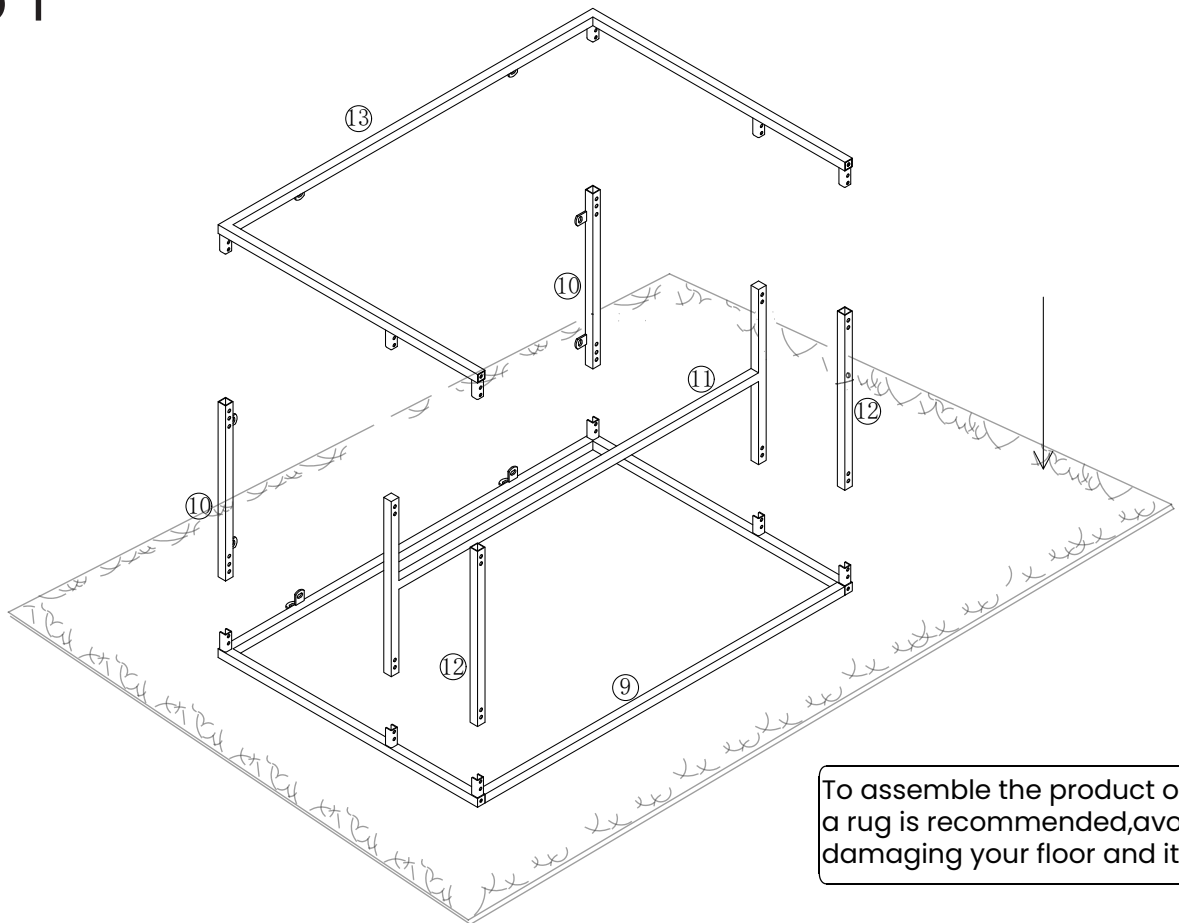

# Step 2

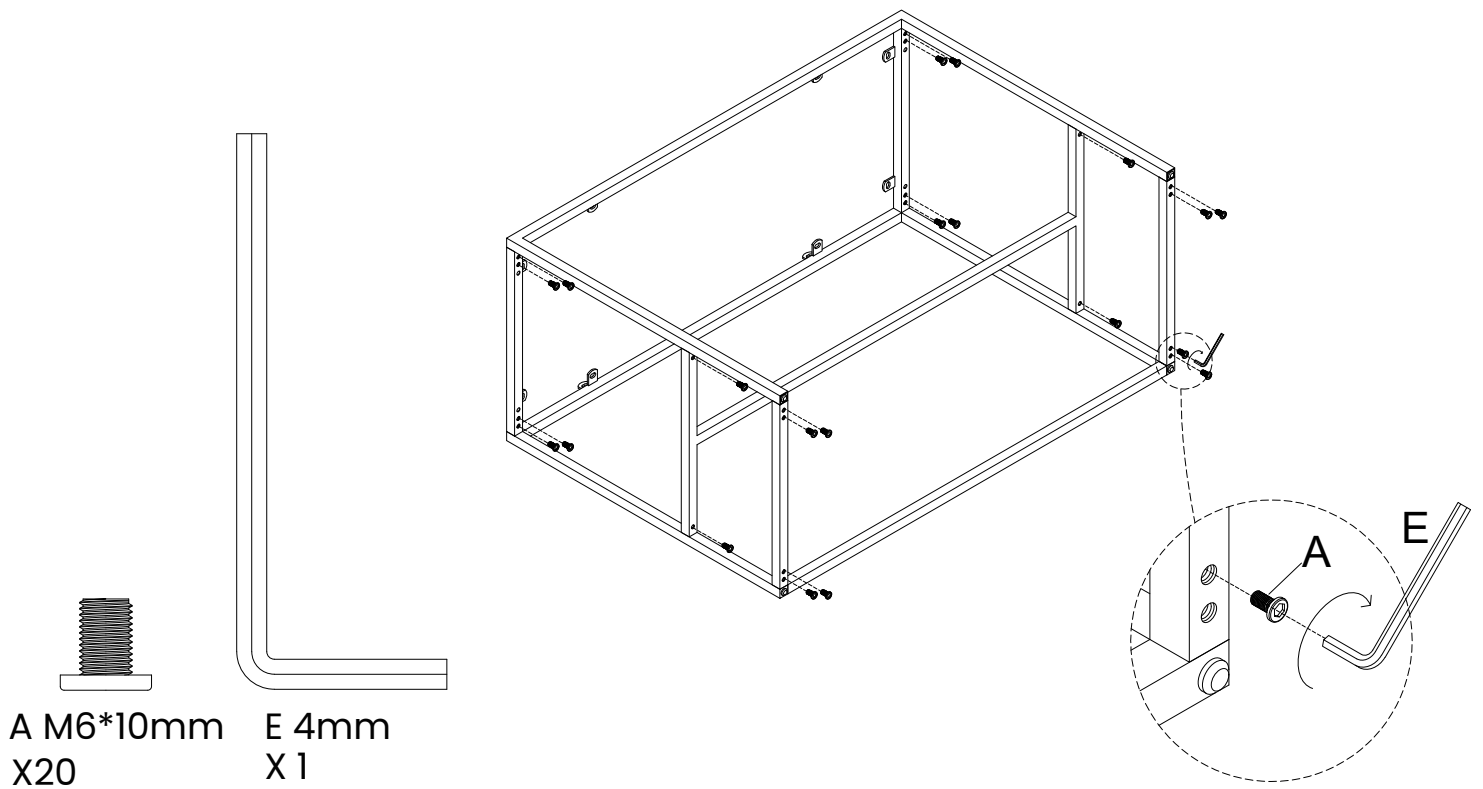

# Step 3

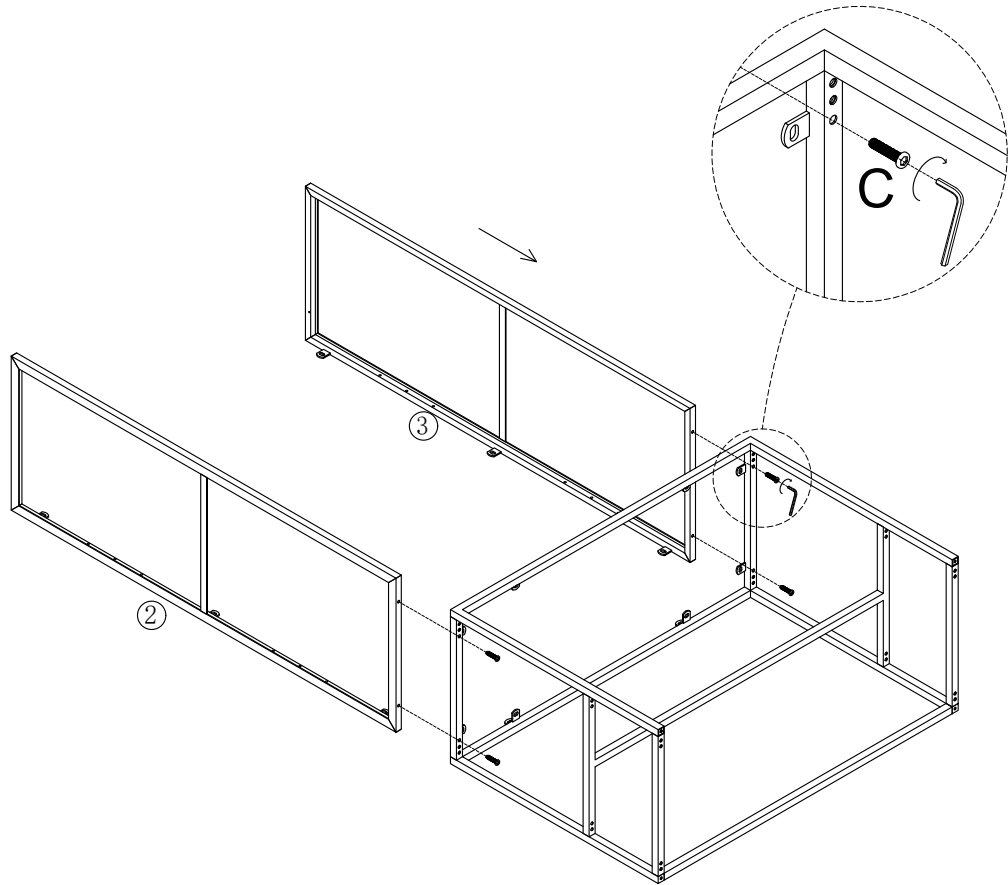

C M6\*25mm  
X 4

# Step 4

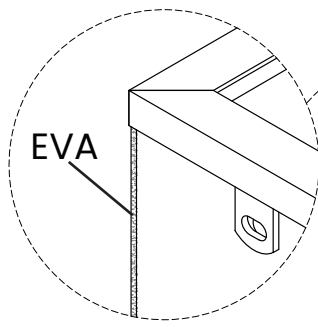
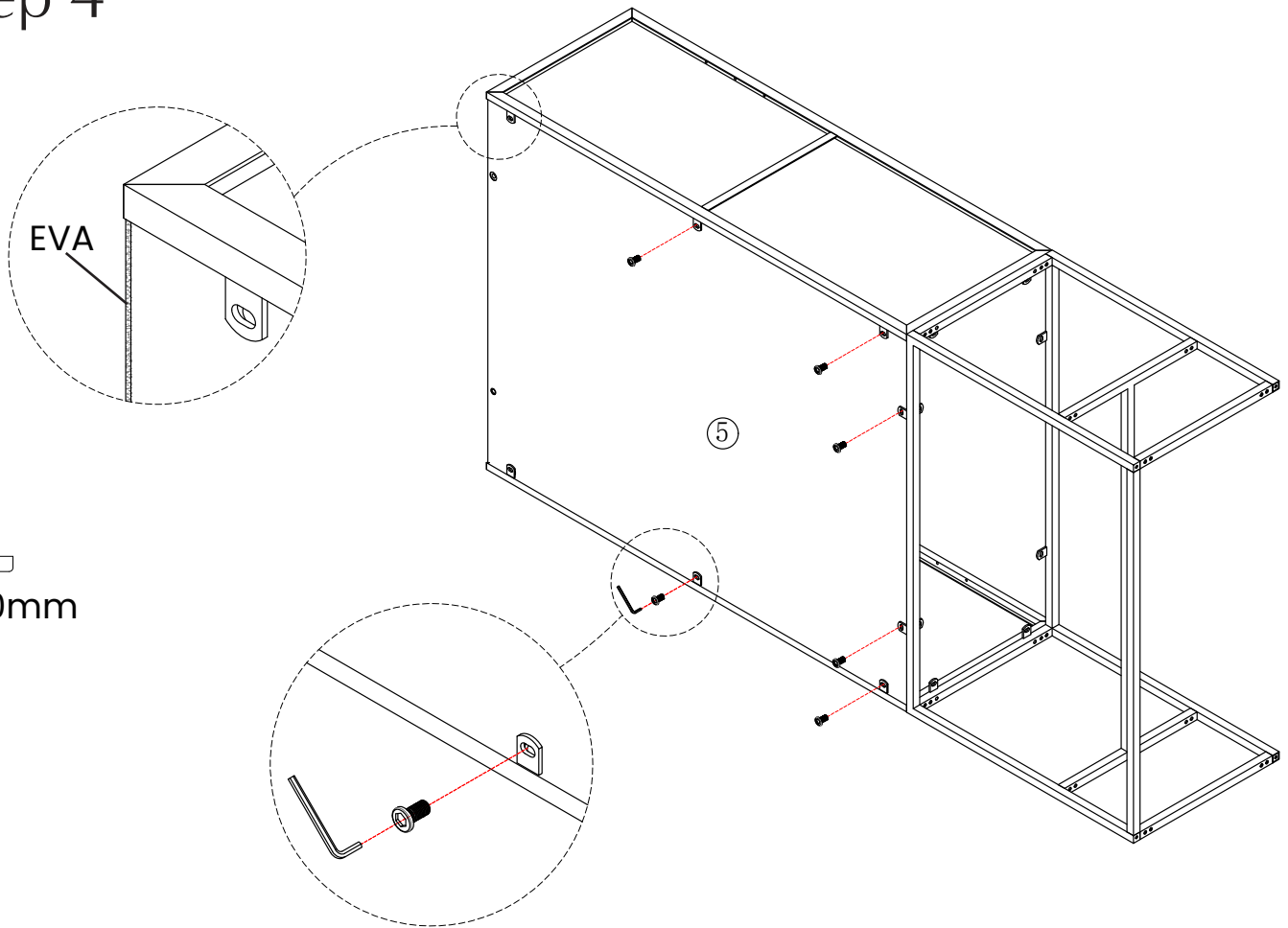

A M6\*10mm  
X 6

 2 person required

# Step 5

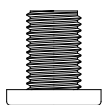
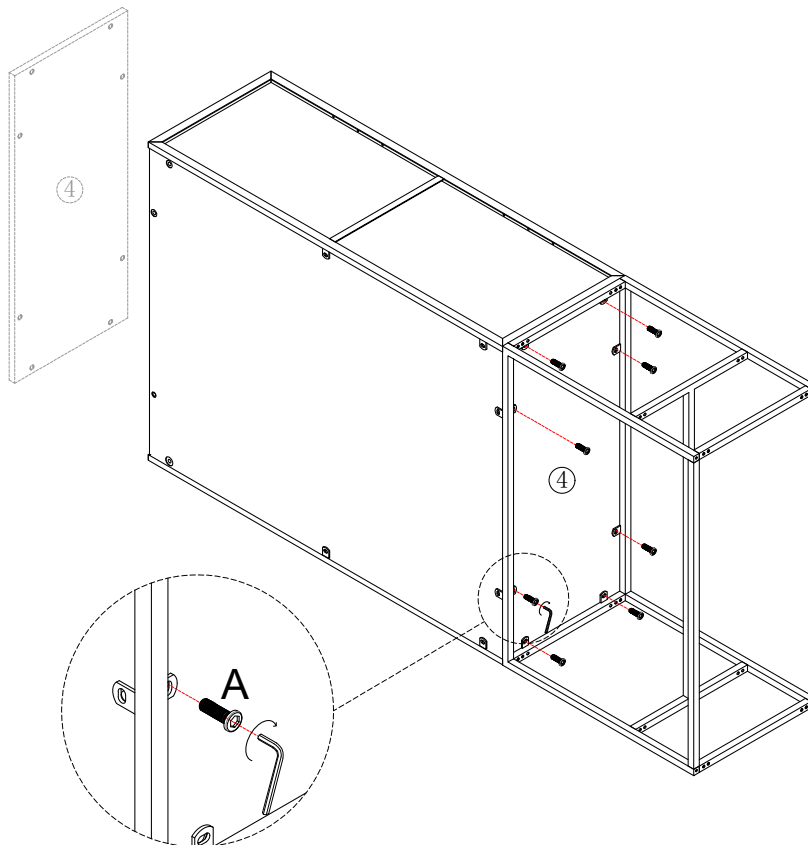

A M6\*10mm  
X8

# Step 6

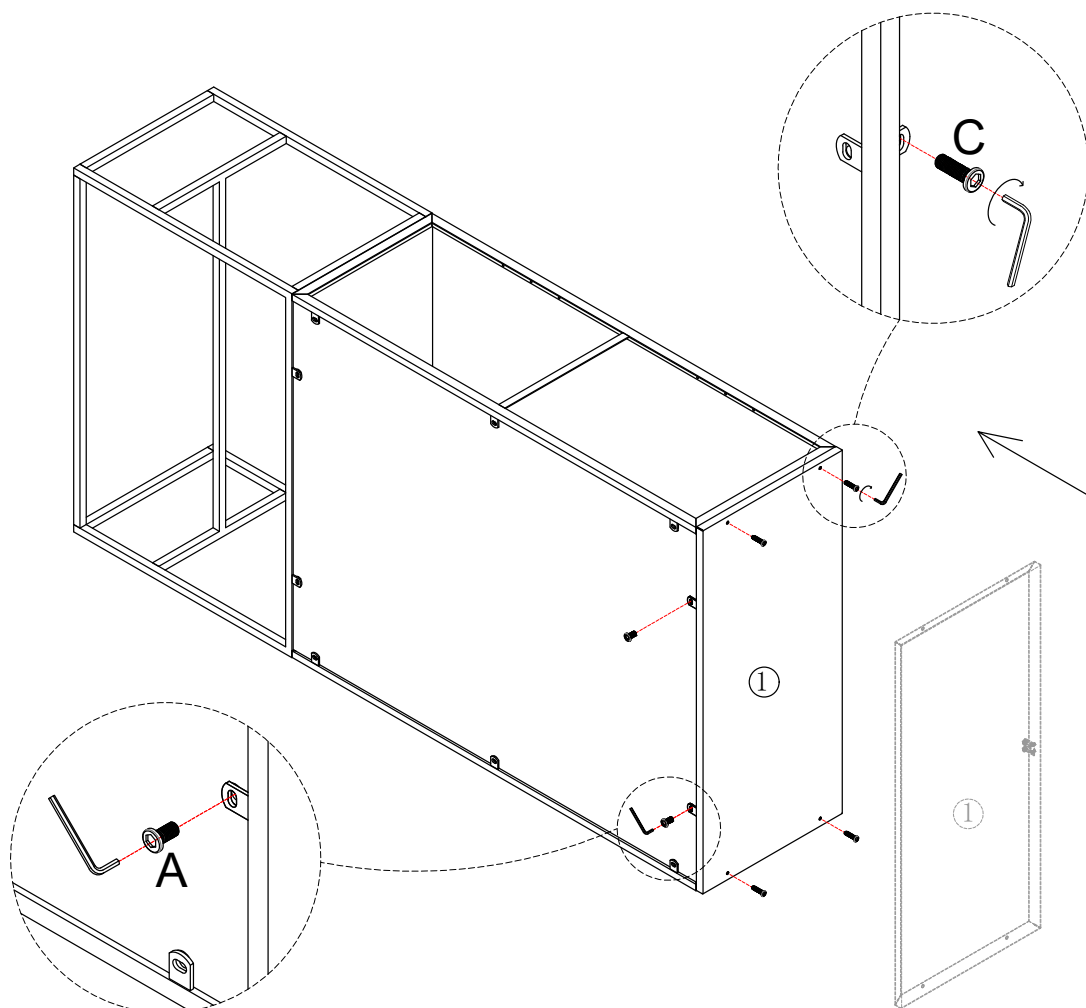

C M6\*25mm  
X4

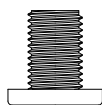

A M6\*10mm  
X2



2 person required

# Step 7

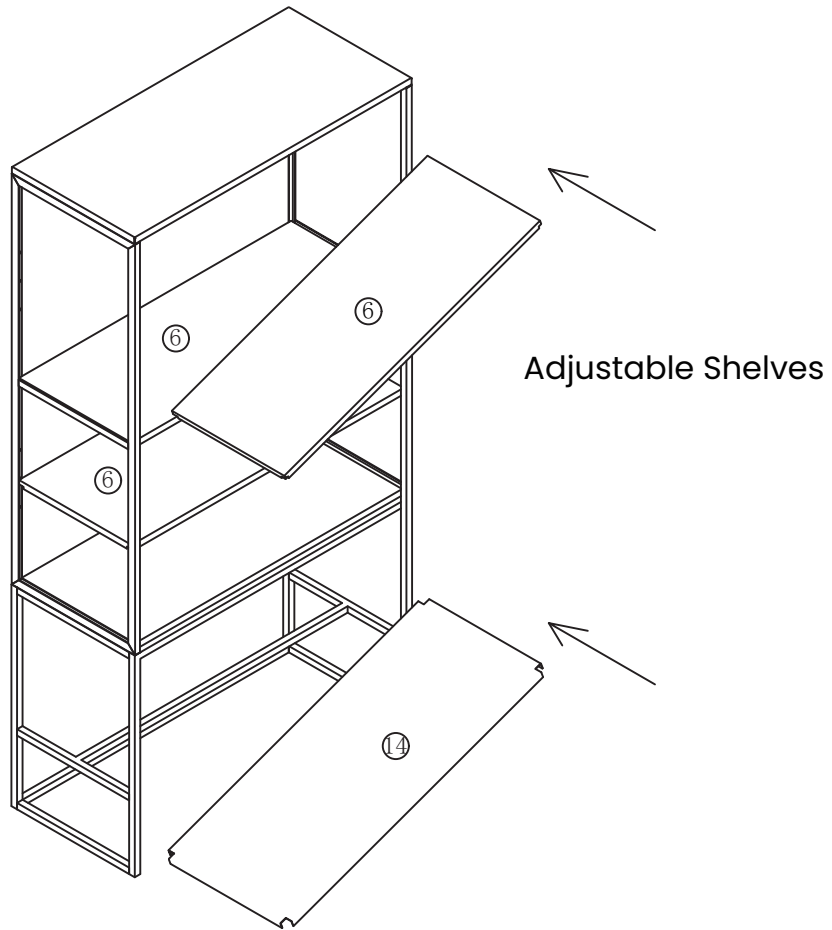

# Step 8

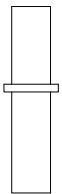
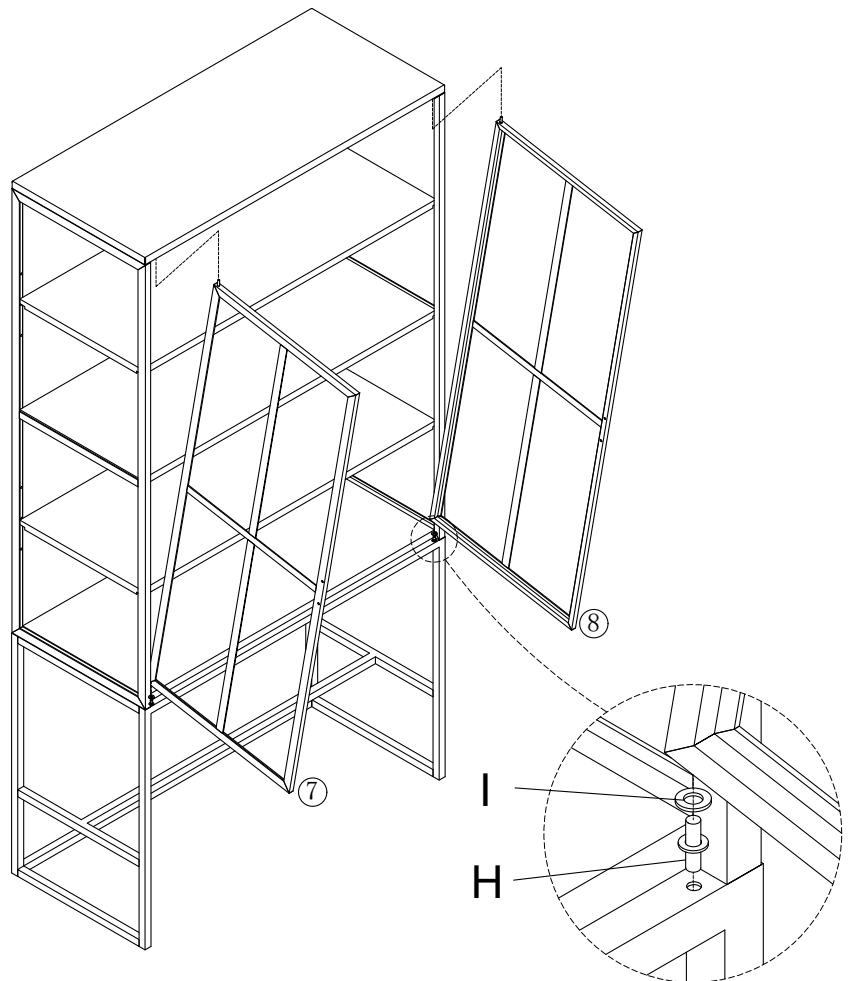

H 7.5\*24  
x2



I 10\*1.5  
x2



2 person required

# Step 9

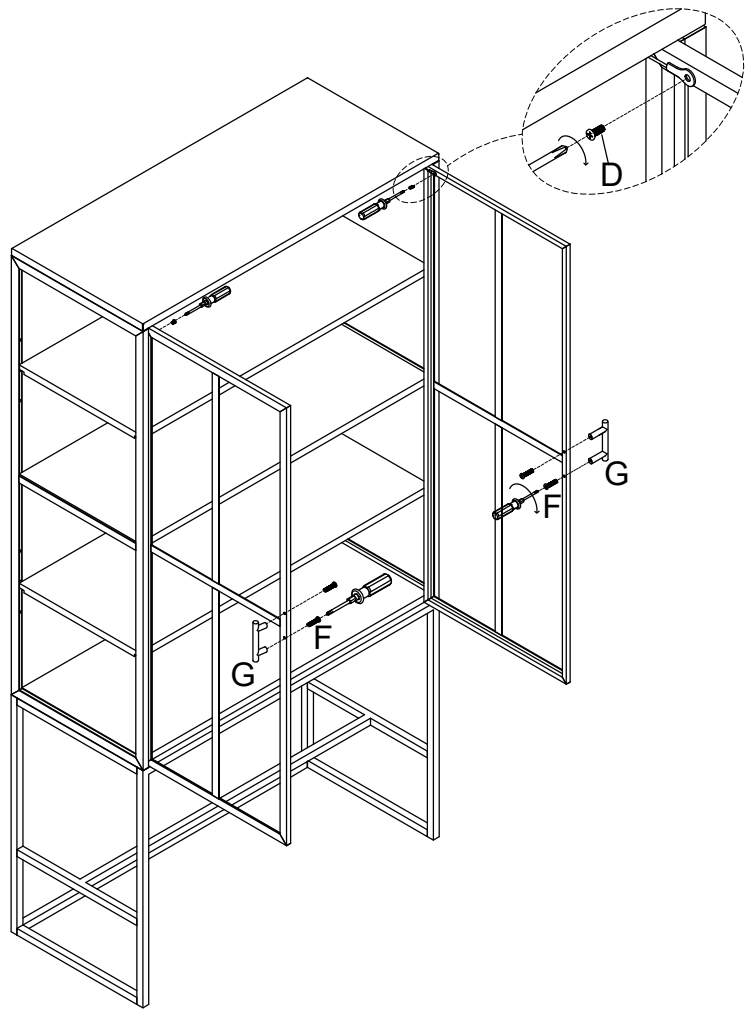
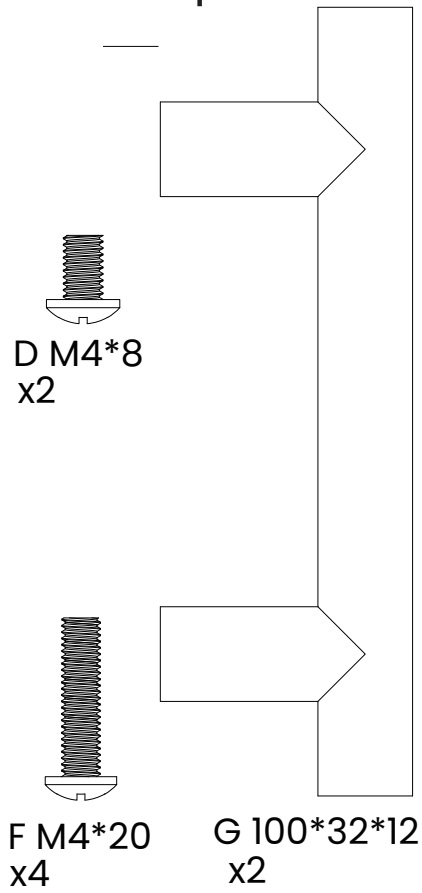

# Step 10

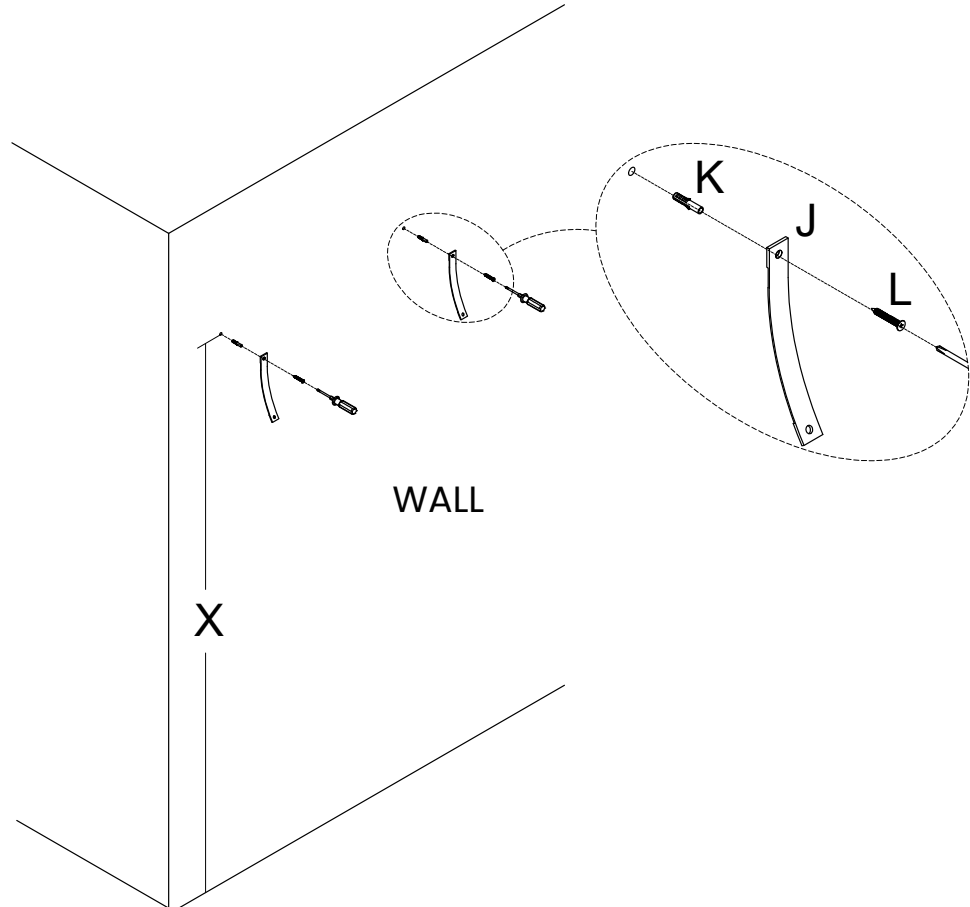
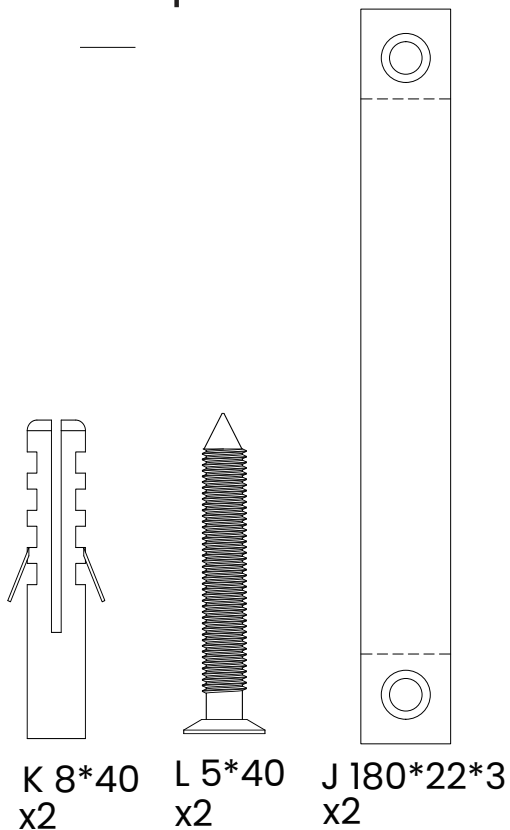

2 person required

# Step 11

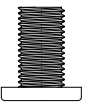
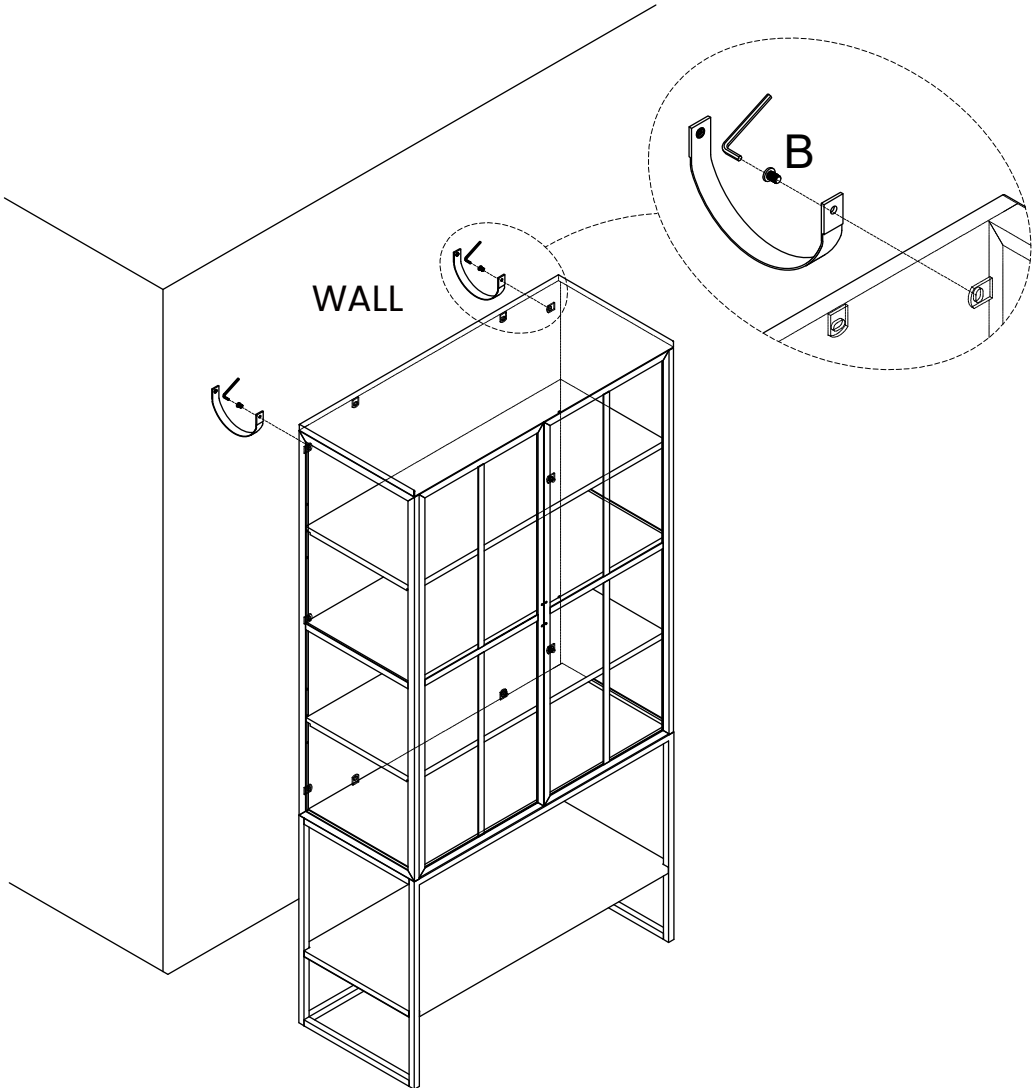

B M6\*12mm  
x2

# Finished!

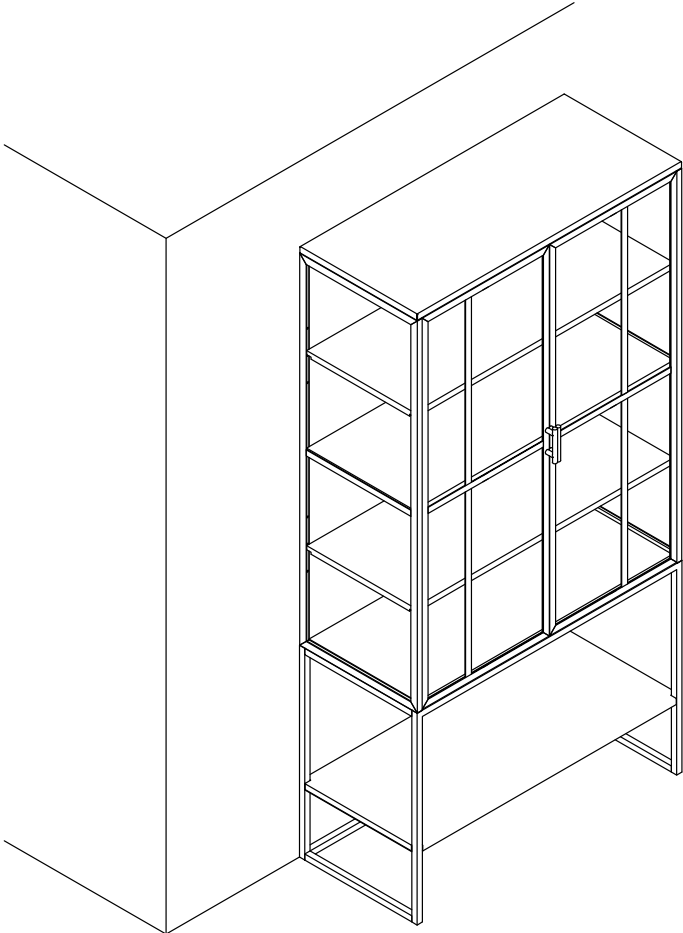

If you found the doors misaligned which related to the floor uneven issue, please try to adjust levelers as below instruction.

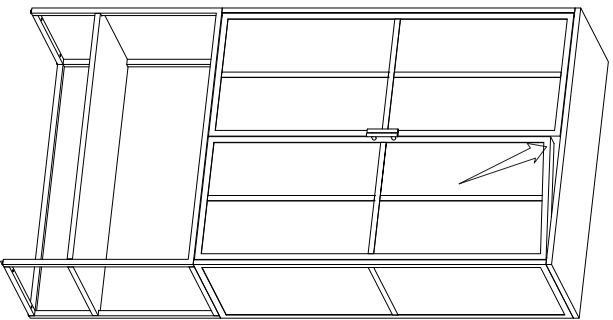

STEP 1

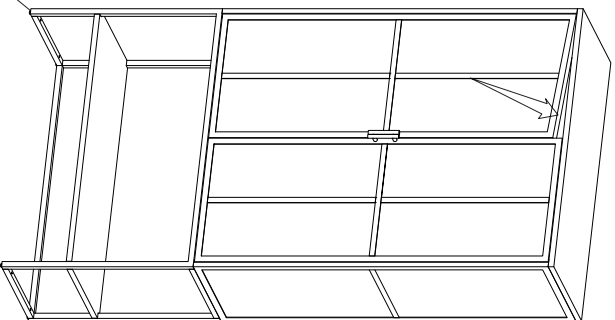
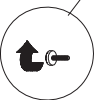

STEP 2

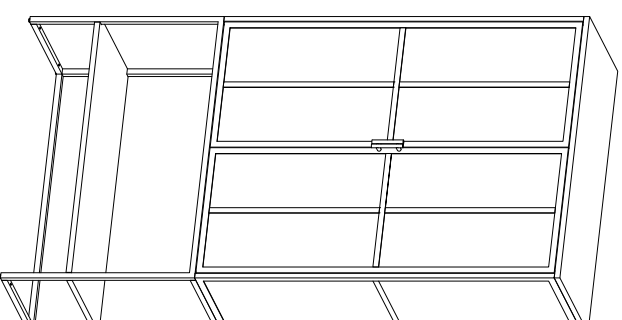
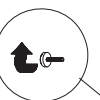

STEP 3

Step 1 The right door is drooping, please adjust the right leveler up.

Step 2 The left door is drooping, please adjust the left leveler up.

Step 3 The doors could be adjusted well.

**Congratulations, we're almost there!**  
**Please perform the following checks:**

1. Have you tightened all the screws?
2. Are the doors misaligned? If yes, please adjust the hinge as per the instructions or watch hinge adjustment video at the product website.

**Always lift your Castlery product when moving it to your preferred location. Levelers (if any) may slant if you drag your product.**

**Finally, clean the product with a clean cloth.**

**You're all set! Enjoy your new living space, thanks to the addition of your Castlery product.**

Note: Your actual product may have minor size differences due to manual measurements.

---

# Care Instructions

**Your furniture, if treated with respect and love, will last you a long time. Each piece requires light maintenance to maximize its longevity.**

- Dust with a soft, dry cloth and clean with a slightly damp cloth.
- Avoid abrasive cleaners & placing rough or sharp objects on the surface.
- Keep furniture away from direct heat or sunlight.
- Wipe spills immediately.
- Use coasters or placemats where possible, to prevent discoloration of the surface.
- Lift when moving, do not drag.
- Periodically check that all connections are tightly-secured.

**Follow the care instructions and look after your furniture. In return, your furniture will look after you. For more information on our care instructions, visit our product website at [www.castlery.com](http://www.castlery.com).**

**We hope to see you soon!**



## WARNING



We strongly recommend to permanently fix this product to a wall or other suitable surface.

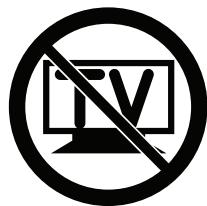

**Children have died from furniture tipover. To reduce the risk of furniture tipover:**

- ALWAYS install anti-tip device provided.
- NEVER put a TV on this product.
- NEVER allow children to stand, climb, or hang on any drawers, doors, or shelves.
- NEVER open more than one drawer at a time.
- Place heavy items down low.