

LUKA CABINET

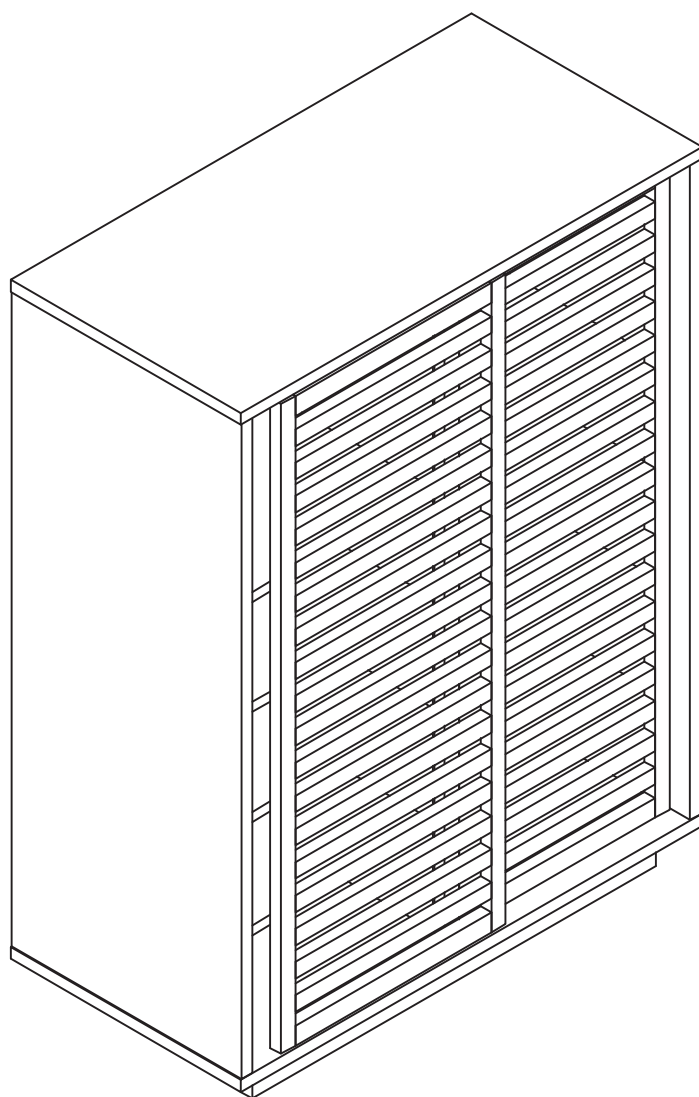

Hello there.

We're so glad that our Castlery product has found a home with you. As proud makers of modern, quality furniture, we're confident that you will love and enjoy your purchase.

Setting it up is easy. Read on for a step-by-step guide to have your item assembled and ready for use.

Once you're done, consider sharing a photo on social media or leaving us a review. We'd love to see how you've styled it in your space.

Thank you for being part of the Castlery community!

Contact us.

Should you have any questions or concerns regarding your purchase, you can contact us via www.castlery.com/contact-us.



www.castlery.com



Before you start...

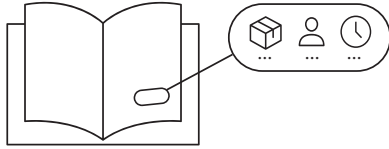

Check that you have received all cartons and familiarize yourself with the assembly requirements. This includes setting aside the allocated time required and having someone to assist you, if needed.



Ensure enough space for assembly. We recommend protecting your floor with a mat or cardboard to avoid scratches during the assembly process.



Read instructions carefully, and check that no parts are missing.

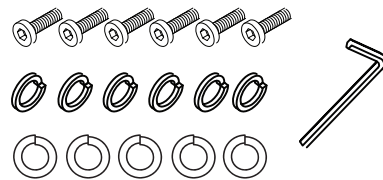

Lay out all hardware on a soft surface so you can easily identify them.



Carefully identify all components to differentiate which pieces are left and right.

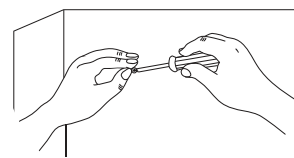

Carefully install your new product following the instructions stated. Don't skip ahead!





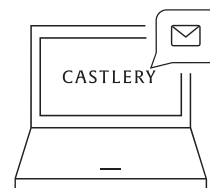

DO NOT over-tighten screws or use a drill. Only professional assemblers should use a drill.



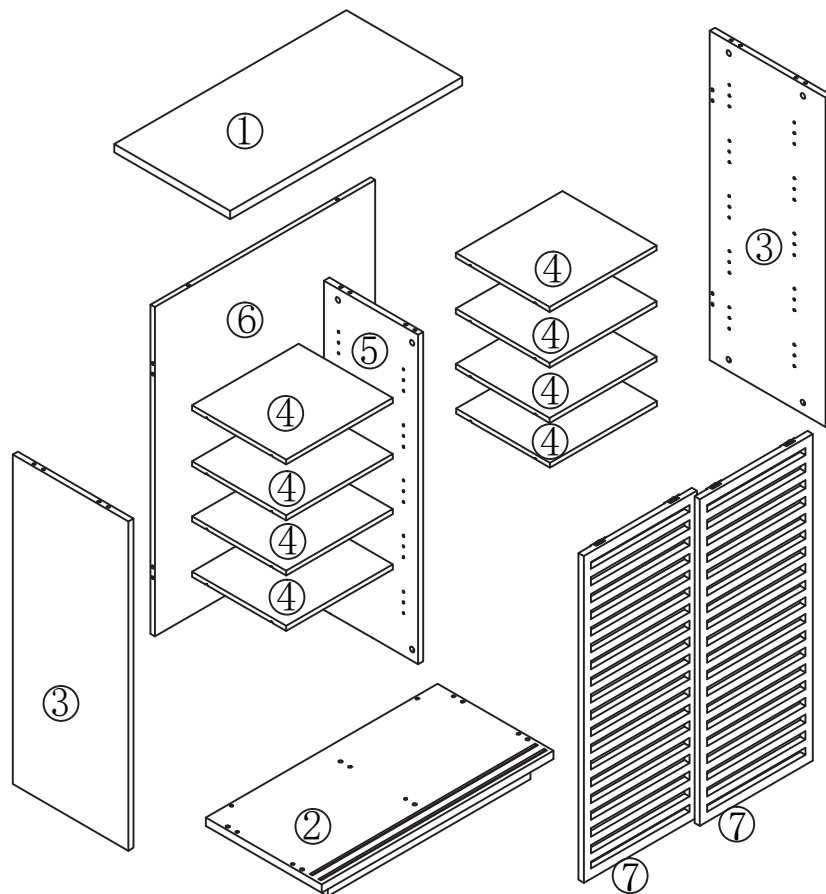



If you need further assistance, please contact us via www.castlery.com/contact-us.

Overview



 **x2**  **x2**  **60 mins**

-  **IMPORTANT: 2 persons needed for assembly.** This will help to minimize potential damage to the product or injury to persons during assembly.
-  There are inner box(es) that include components required to complete this assembly.
-  Please do not completely tighten all the hardware, until each assembly step is complete.
-  Before discarding the packaging, please use the checklist to ensure that you have all the parts required to assemble your product. Please kindly note if applicable please keep the original package when you want to return the product later.
-  If parts are missing or damaged, we will gladly ship your replacements parts free of charge. Please contact us via www.castlery.com/contact-us. Illustrations in this guide are for reference only and may be slightly different from the actual object.

Parts

BOX 1 OF 2

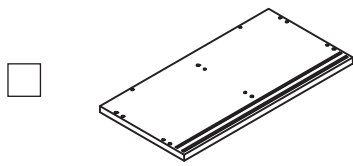

① Top Panel
x1

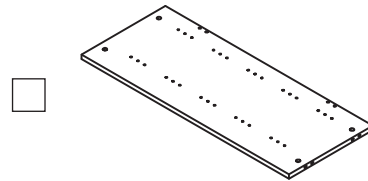

③ Side Panel
x2

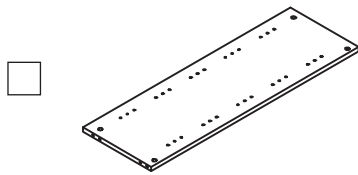

⑤ Vertical Divider
x1

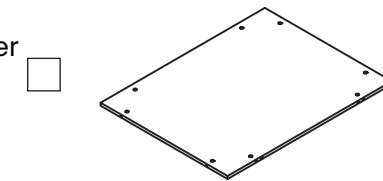

⑥ Back Panel
x1

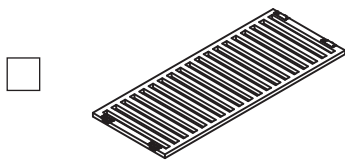

⑦ Sliding Door
x2

BOX 2 OF 2

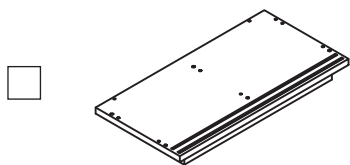



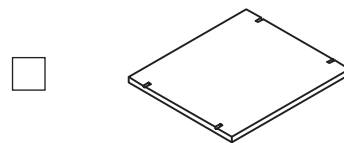





② Bottom Panel
x1

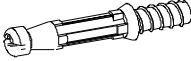

④ Shelf
x8

Hardware

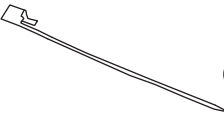
BOX 2 OF 2

- | | | | | | | | |
|--------------------------|---|-----|--|--------------------------|--|-----|---|
| <input type="checkbox"/> |  | (A) | Cambolt $\varnothing 6 \times 35 \text{mm}$
x20 | <input type="checkbox"/> |  | (B) | Dowel $\varnothing 8 \times 30 \text{mm}$
x16 |
| <input type="checkbox"/> |  | (C) | Camlock $\varnothing 15 \text{mm}$
x20 | <input type="checkbox"/> |  | (D) | Sticker $\varnothing 20$
x20 |
| <input type="checkbox"/> |  | (E) | Shelf Pin $\varnothing 6 \text{mm}$
x32 | <input type="checkbox"/> |  | (F) | Long Screw $\varnothing 3.5 \times 35 \text{mm}$
x4 |
| <input type="checkbox"/> |  | (G) | Short Screw $\varnothing 3.5 \times 15 \text{mm}$
x4 | <input type="checkbox"/> |  | (H) | Restraint Strap
x2 |
| <input type="checkbox"/> |  | (I) | Plastic Bracket
x4 | <input type="checkbox"/> |  | (J) | Wall Anchor
x4 |

Step 1

Do not screw too deep or shallow

Hammer
(Not provided)

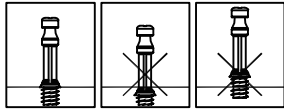

Cross-head Screwdriver
(Not provided)

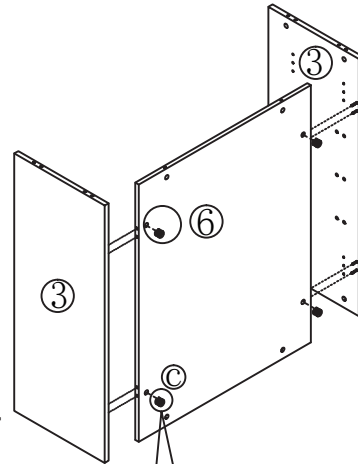
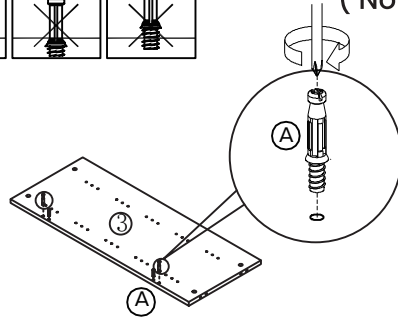
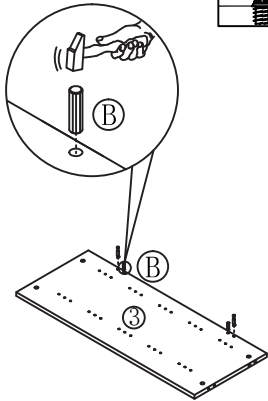

Cross-head Screwdriver
(Not provided)

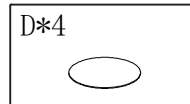
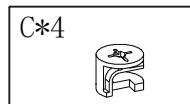
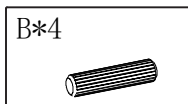
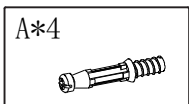
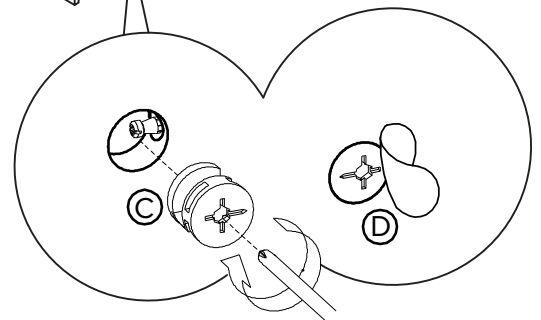
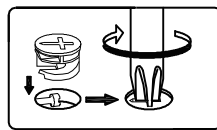

Step 2



Do not screw too deep or shallow

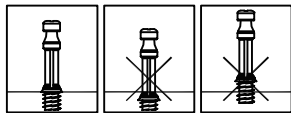



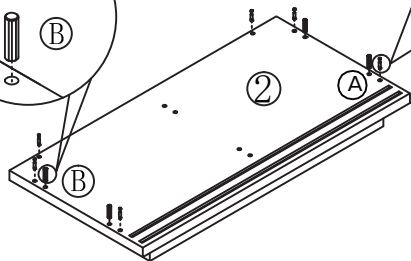
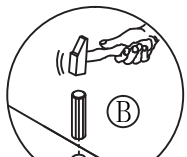

Hammer
(Not provided)

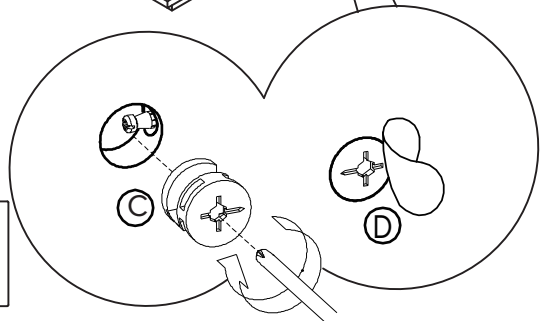
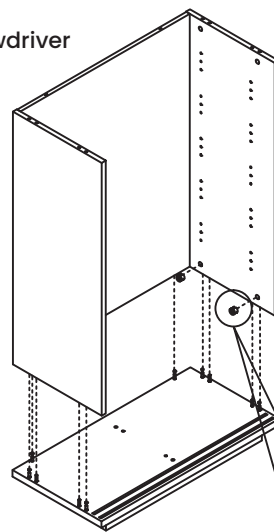
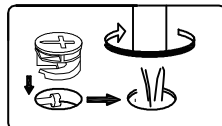
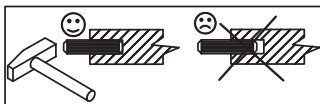

Cross-head Screwdriver
(Not provided)

Cross-head Screwdriver
(Not provided)



- | | | | |
|--|--|--|--|
| A*6
 | B*4
 | C*6
 | D*6
 |
|--|--|--|--|

Step 3

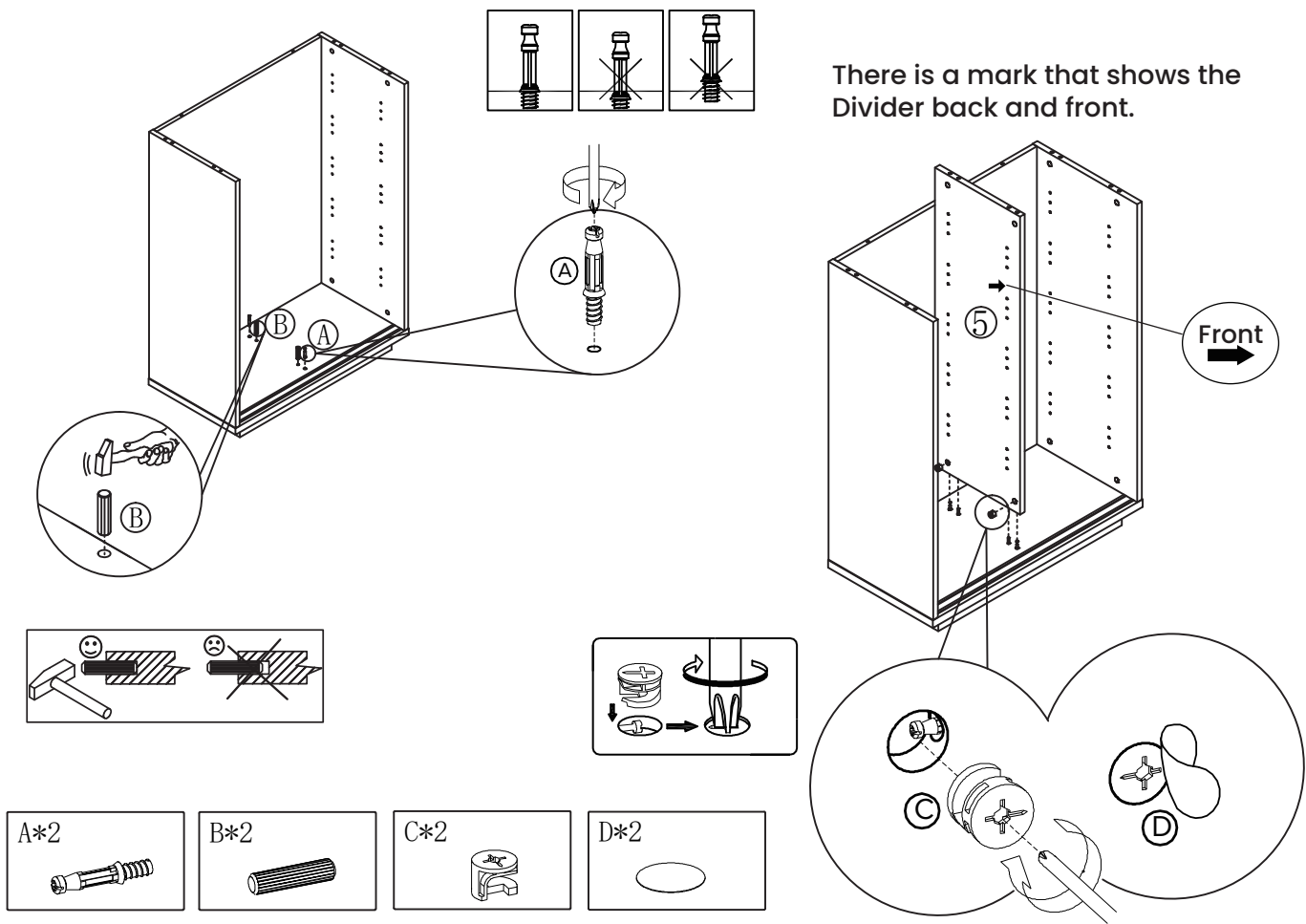

There is a mark that shows the Divider back and front.

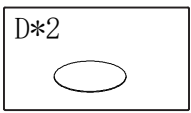
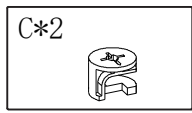
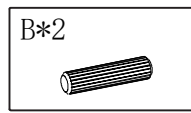
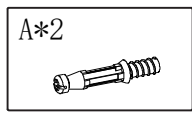
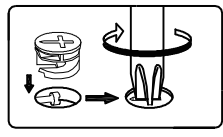
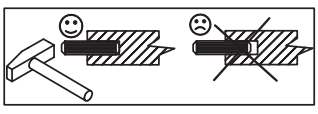
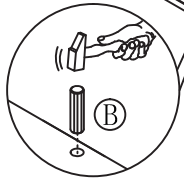
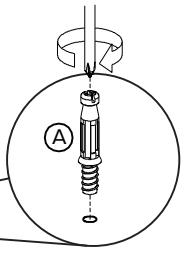
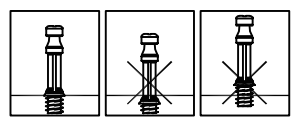

Step 4

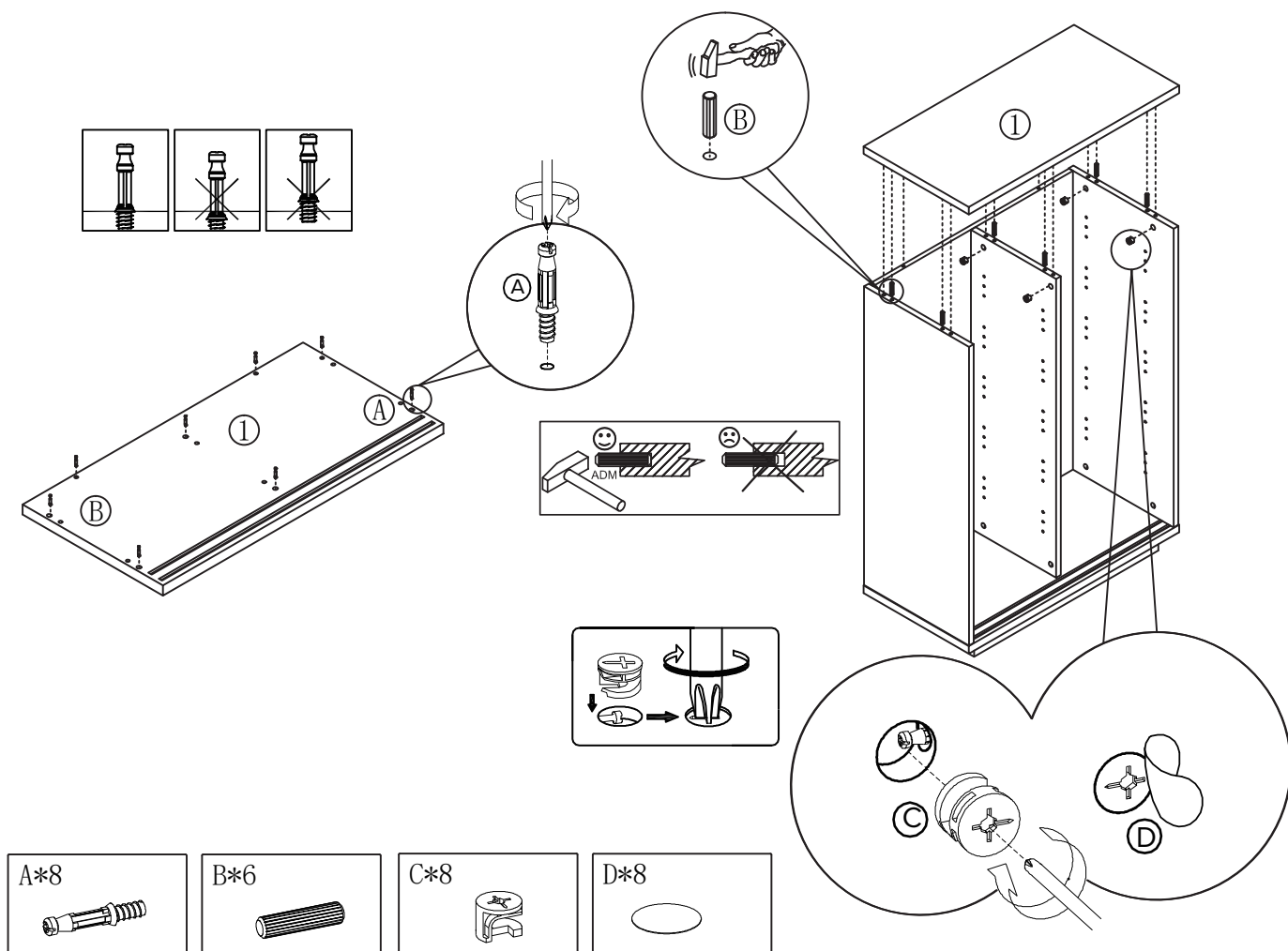

Step 5

To assemble the door, you need put the top of the door into the sliding rail and push it up, meanwhile put the door bottom into the sliding rail

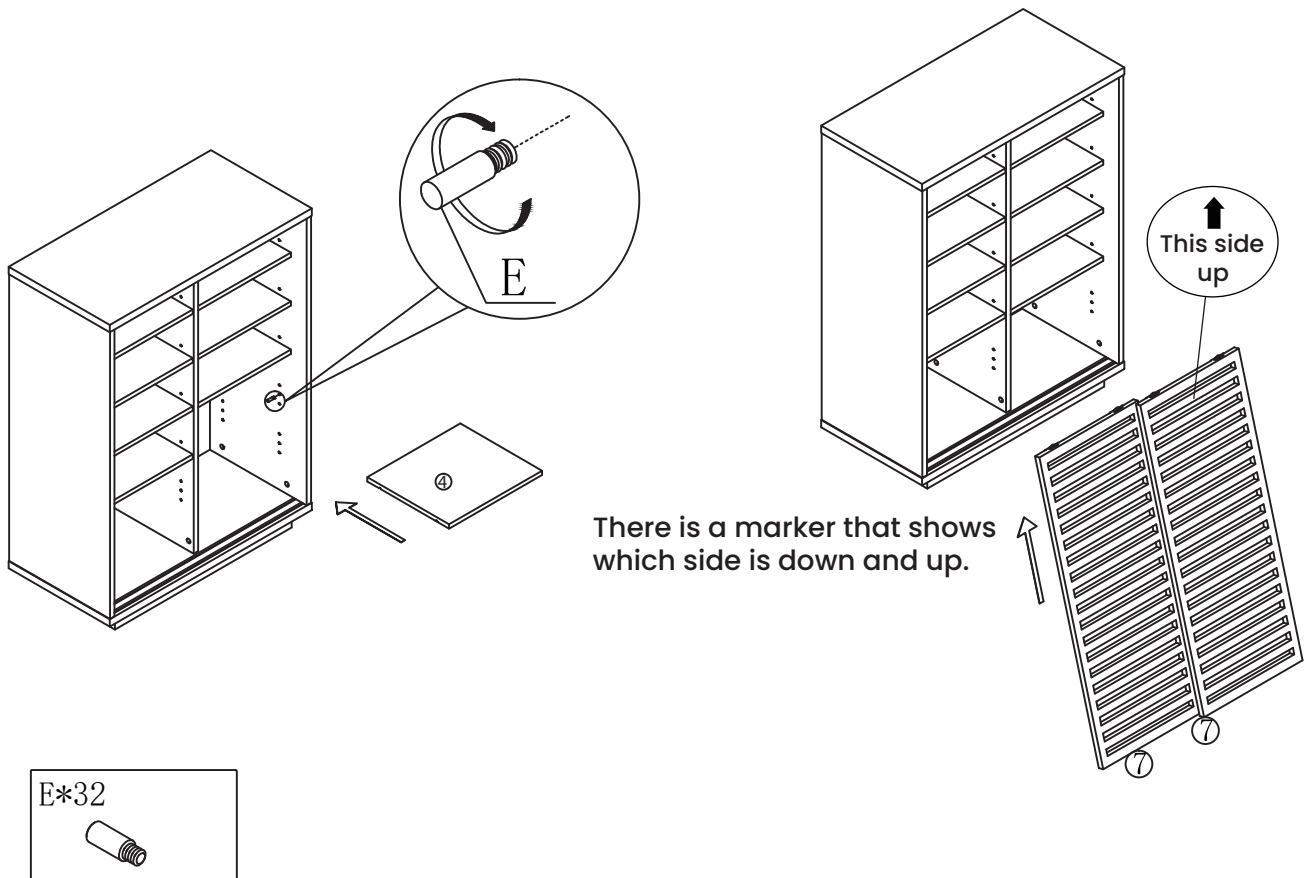

Finished!

Congratulations, we're almost there!
Please perform the following checks:

1. To ensure bolts are tightened.
2. Do not miss the bolts installation.

Always lift your Castlery product when moving it to your preferred location. Levelers (if any) may slant if you drag your product.

Finally, dust the product with a clean cloth (if needed).

You're all set! Enjoy your new living space, thanks to the addition of your Castlery product.

Note: Your actual product may have minor size differences due to manual measurements.

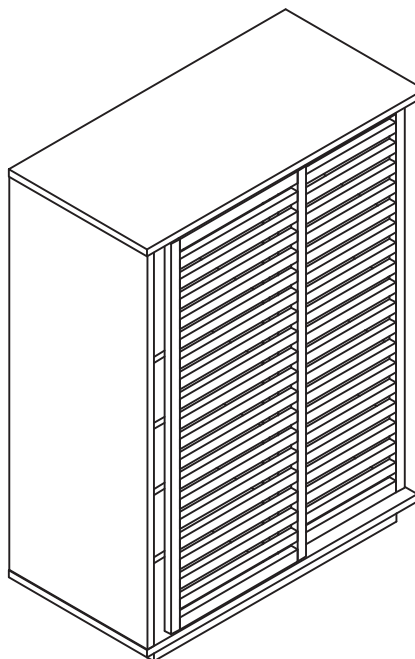

Anti-tip Kit Assembly Instruction

To prevent injury and property damage from unexpected tipping of furniture, we highly recommend installation of the anti-tip kit included with this product.

Step 1

Determine where the piece is to be placed and mark location on the wall for the mounting bracket screw holes. They should be placed approximately 1" below the top on the back of the piece of furniture.

wall anchors

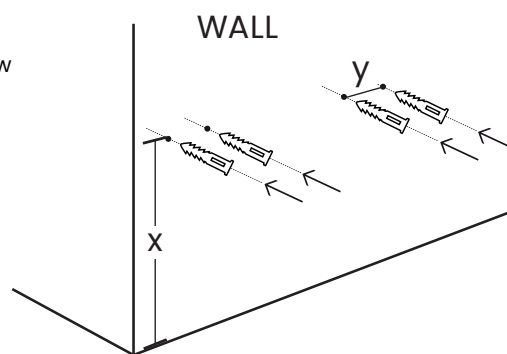

*Repeat for all 4 Wall Anchors.

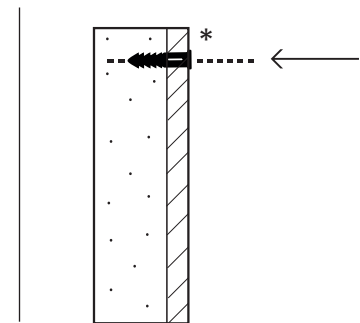

Step 2

Attach the mounting bracket vertically/ horizontally to the wall by inserting the long screws provided through the holes in the bracket and tightening securely using screw-driver. Screws must penetrate wall studs for proper installation.

Long screws



plastic brackets

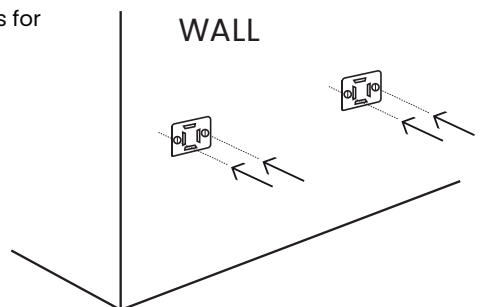

*Repeat for all 4 screws.

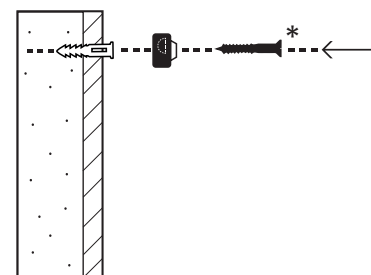

Please seek a professional advice if unsure of wall constructions. Properly affixing furniture to your wall will depend on the wall material: concrete, drywall, masonry, or wood will require the appropriate hardware. Anchor is not provided, please source the right anchor according to the wall type. Please consult your local hardware store to ensure you are using the correct hardware for your wall type.

Step 3

Next using the short screws attach the 2nd bracket to the back of the piece of furniture's top.

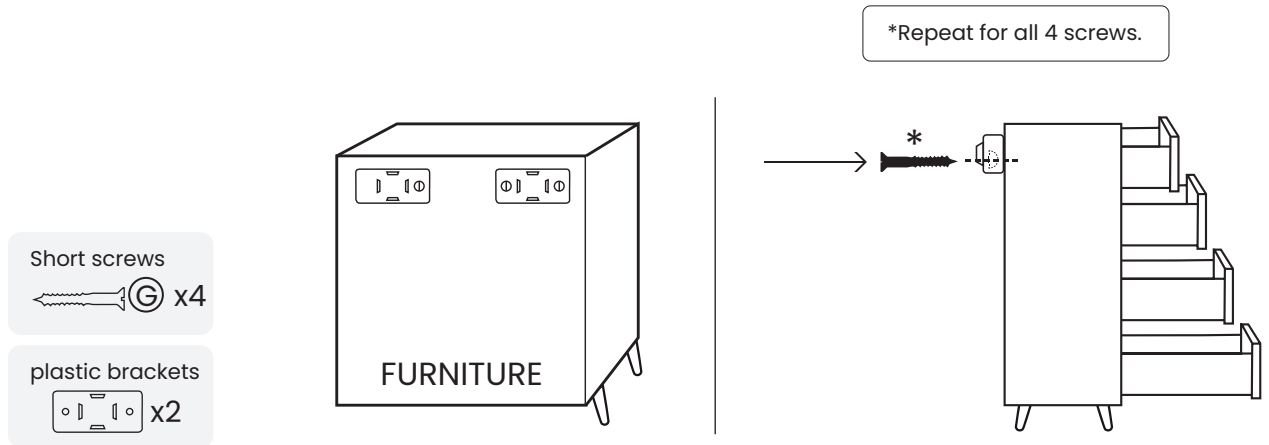

Step 4

Lace the nylon strap down through the brackets. Slide the thin end of the strap through the receiving end of the nylon strap. Pull to tighten the piece of furniture snug against wall.

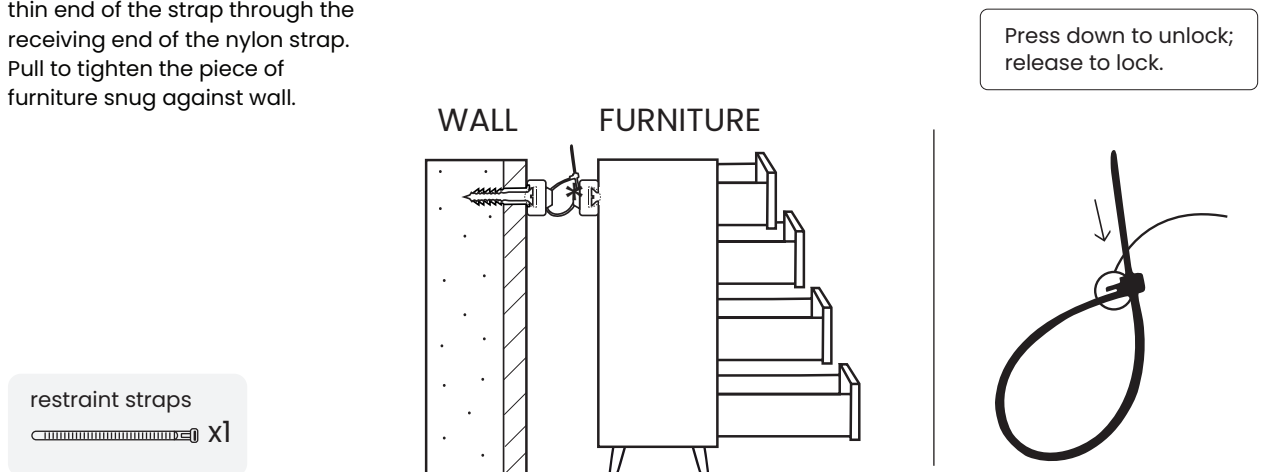

- This anti-tip kit is not a substitute for proper adult supervision.
- This anti-tip kit may provide protection against tipping furniture.
- Do not allow children to climb on furniture.
- By installing anti-tip kit, you acknowledge that you are fully aware of the safety requirements and accept to adhere to it.
- Illustrations in this guide are for reference only and may be slightly different from the actual object.

Care

Instructions

Your furniture, if treated with respect and love, will last you a long time. Each piece requires light maintenance to maximize its longevity.

Storage Furniture Care

- Dust with a soft, dry cloth and clean with a slightly damp cloth.
- Avoid abrasive cleaners and placing rough or sharp objects on the surface.
- Keep furniture away from direct heat or sunlight.
- Wipe spills immediately.
- Use coasters or placemats where possible, to prevent discoloration of the surface.
- Lift when moving, do not drag.
- Periodically check that all connections are tightly secured.

Follow the care instructions and look after your furniture. In return, your furniture will look after you. For more information on our care instructions, visit our product website at www.castlery.com.

We hope to see you soon!