

ALEXANDER FLOOR MIRROR

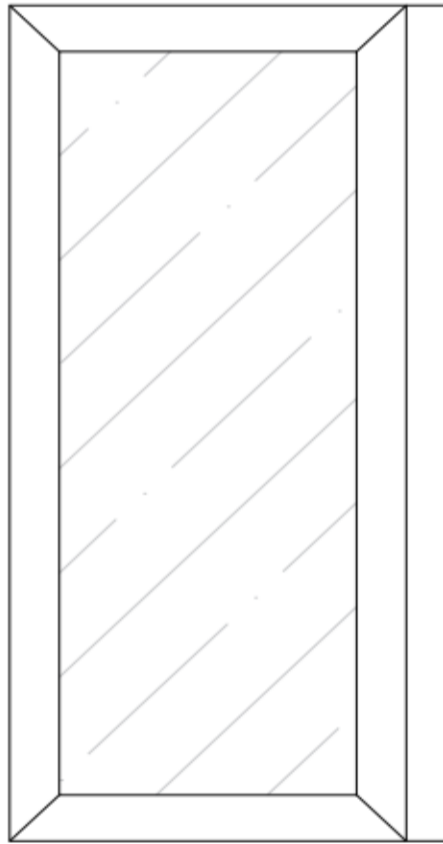

Hello there.

We're so glad that our Castlery product has found a home with you. As proud makers of modern, quality furniture, we're confident that you will love and enjoy your purchase.

Setting it up is easy. Read on for a step-by-step guide to have your item assembled and ready for use.

Once you're done, consider sharing a photo on social media or leaving us a review. We'd love to see how you've styled it in your space.

Thank you for being part of the Castlery community!

Contact us.

Should you have any questions or concerns regarding your purchase, you can contact us via www.castlery.com/contact-us.



www.castlery.com



Before you start...

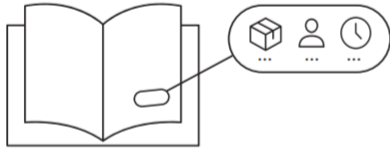

Check that you have received all cartons and familiarize yourself with the assembly requirements. This includes setting aside the allocated time required and having someone to assist you, if needed.



Ensure enough space for assembly. We recommend protecting your floor with a mat or cardboard to avoid scratches during the assembly process.

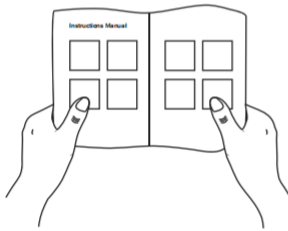

Read instructions carefully, and check that no parts are missing.

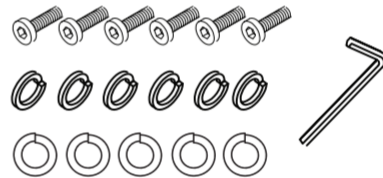

Lay out all hardware on a soft surface so you can easily identify them.

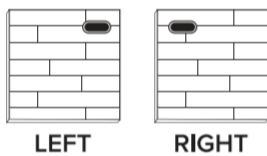

Carefully identify all components to differentiate which pieces are left and right.

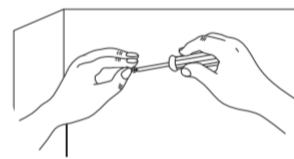

Carefully install your new product following the instructions stated. Don't skip ahead!

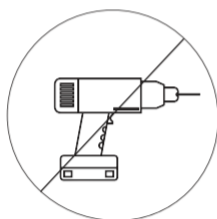



DO NOT over-tighten screws or use a drill. Only professional assemblers should use a drill.





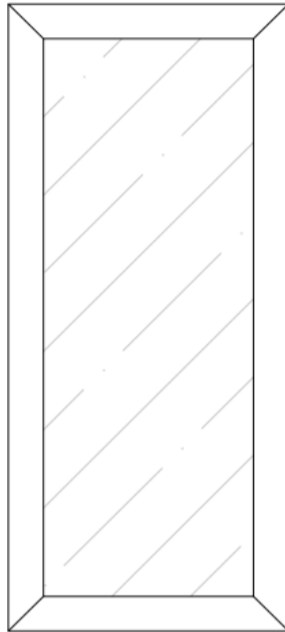

If you need further assistance, please contact us via www.castlery.com/contact-us.

Overview

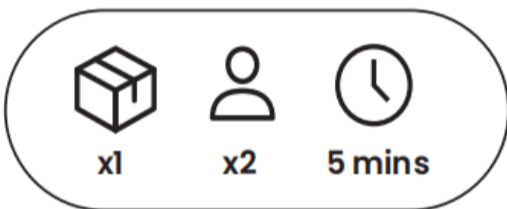

 Batch code label is located on the back of the product.



-
-  There are inner box(es) that include components required to complete this assembly.
 -  Please do not completely tighten all the hardware, until each assembly step is complete.
 -  Before discarding the packaging, please use the checklist to ensure that you have all the parts required to assemble your product. Please kindly note if applicable please keep the original package when you want to return the product later.
 -  If parts are missing or damaged, we will gladly ship your replacement parts free of charge. Please contact us via www.castlery.com/contact-us. Illustrations in this guide are for reference only and may be slightly different from the actual object.

Parts

BOX 1 OF 1



Hardware

BOX 1 OF 1

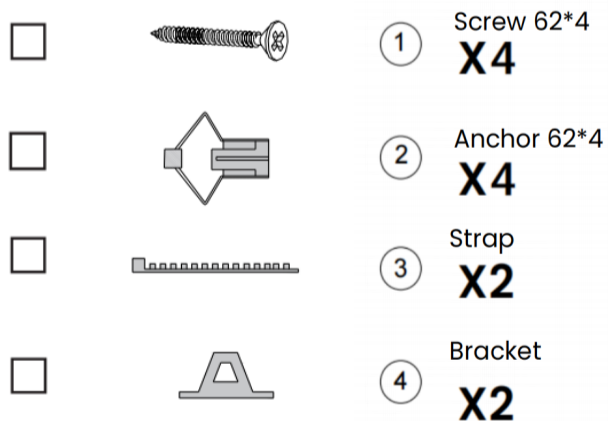

**You might need a screwdriver (+/-) to complete this assembly.*

Step 1

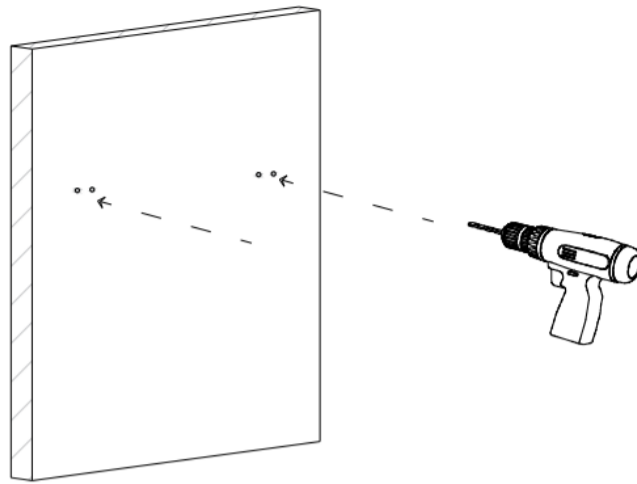

Step 2

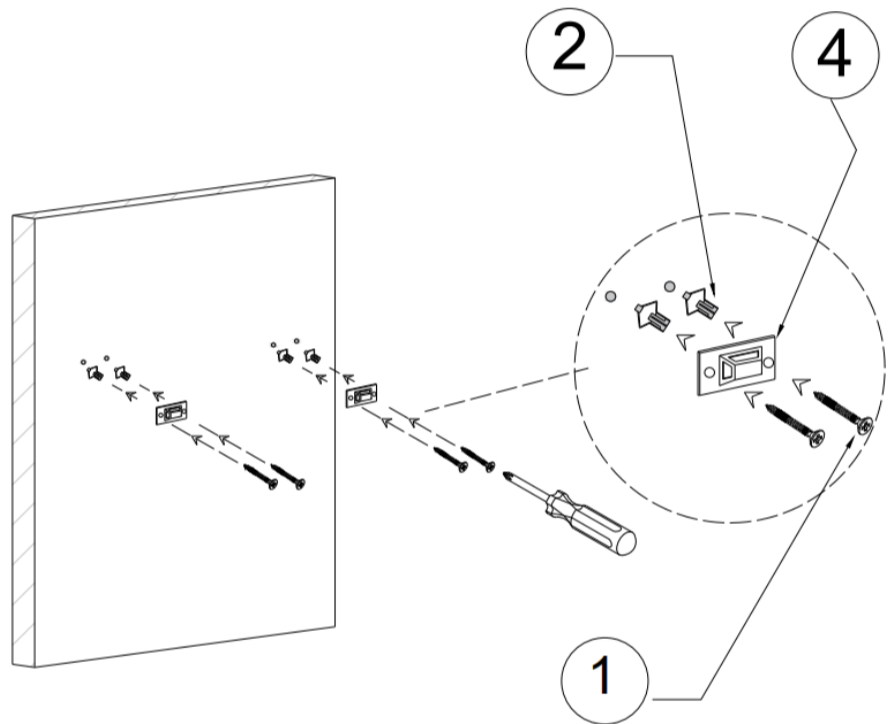

Step 3

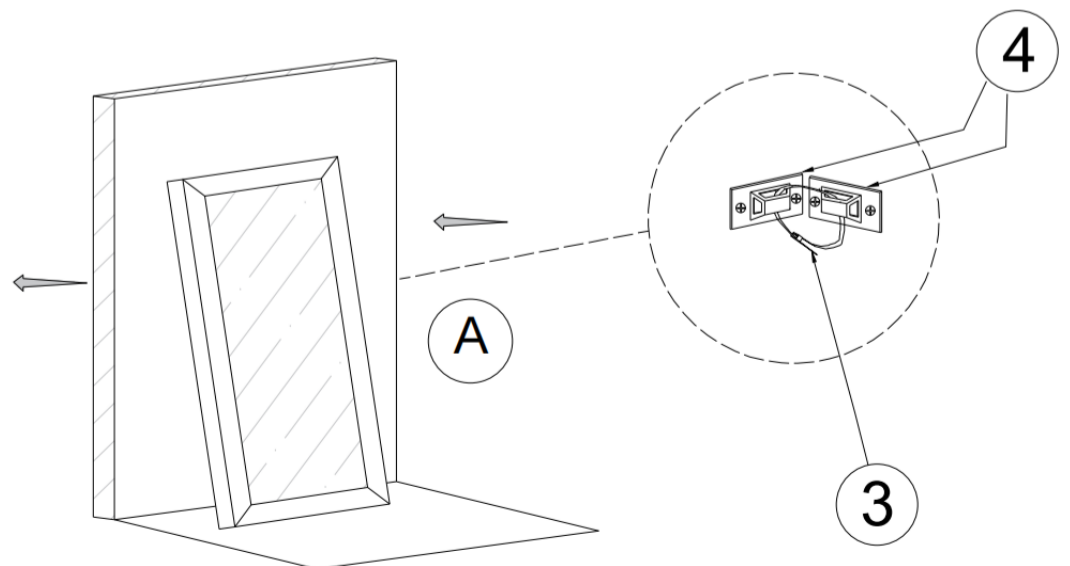

Finished!

Congratulations, we're almost there!
Please perform the following checks:

Finally, dust the product with a clean cloth (if needed).

You're all set! Enjoy your new living space, thanks to the addition of your Castlery product.

Note: Your actual product may have minor size differences due to manual measurements.

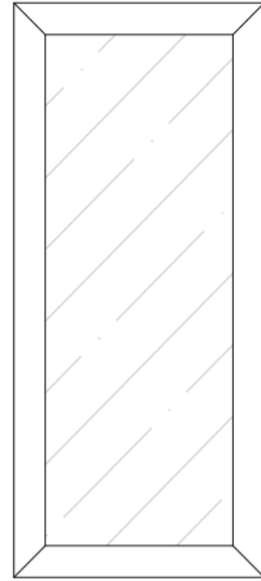

Care

Instructions

Your furniture, if treated with respect and love, will last you a long time. Each piece requires light maintenance to maximize its longevity

General Care

- Ensure wiping mirror clean with warm water before drying it with a dry microfibre cloth.
- Only wipe mirror using small circular motions and light pressure to prevent scratches.
- Avoid using paper towels as they can be abrasive and inclined to cause scratches.
- Avoid using acid or alkali cleaning solutions on mirror as these substances may cause chemical damage on the front surface, edges, and backing of the mirror.
- Ensure the edges and backing of the mirror are dry. Wet areas may be damaged quicker or create water spots around the mirror.

Follow the care instructions and look after your furniture. In return, your furniture will look after you. For more information on our care instructions, visit our product website at www.castlery.com.

We hope to see you soon!