

RIO OUTDOOR DINING CHAIR

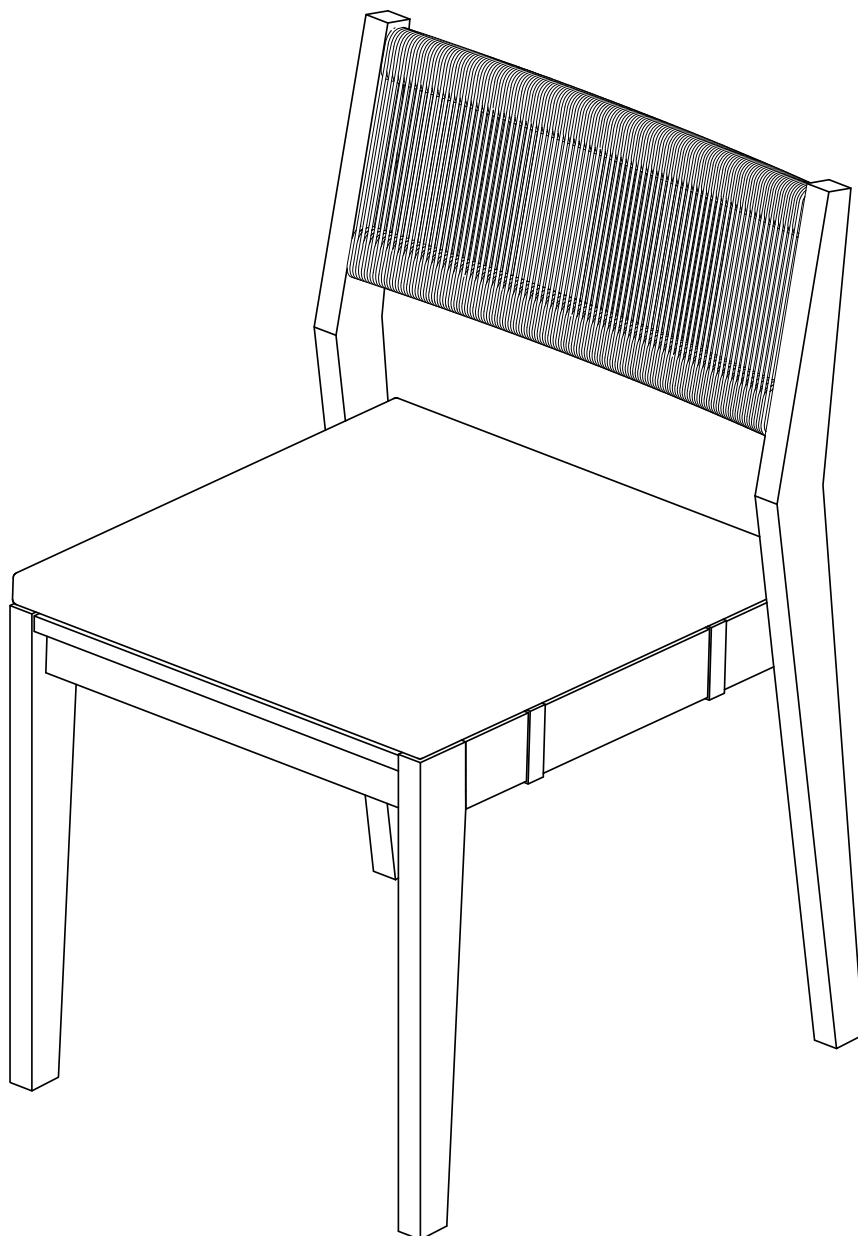

Assembly Instructions & Care Guide

CASTLERY

Hello there.

We're so glad that our Castlery product has found a home with you. As proud makers of modern, quality furniture, we're confident that you will love and enjoy your purchase.

Setting it up is easy. Read on for a step-by-step guide to have your item assembled and ready for use.

Once you're done, consider sharing a photo on social media or leaving us a review. We'd love to see how you've styled it in your space.

Thank you for being part of the Castlery community!

Contact us.

For any enquiries or issues regarding your purchase, you can contact us via www.castlery.com/contact-us.



www.castlery.com

Overview

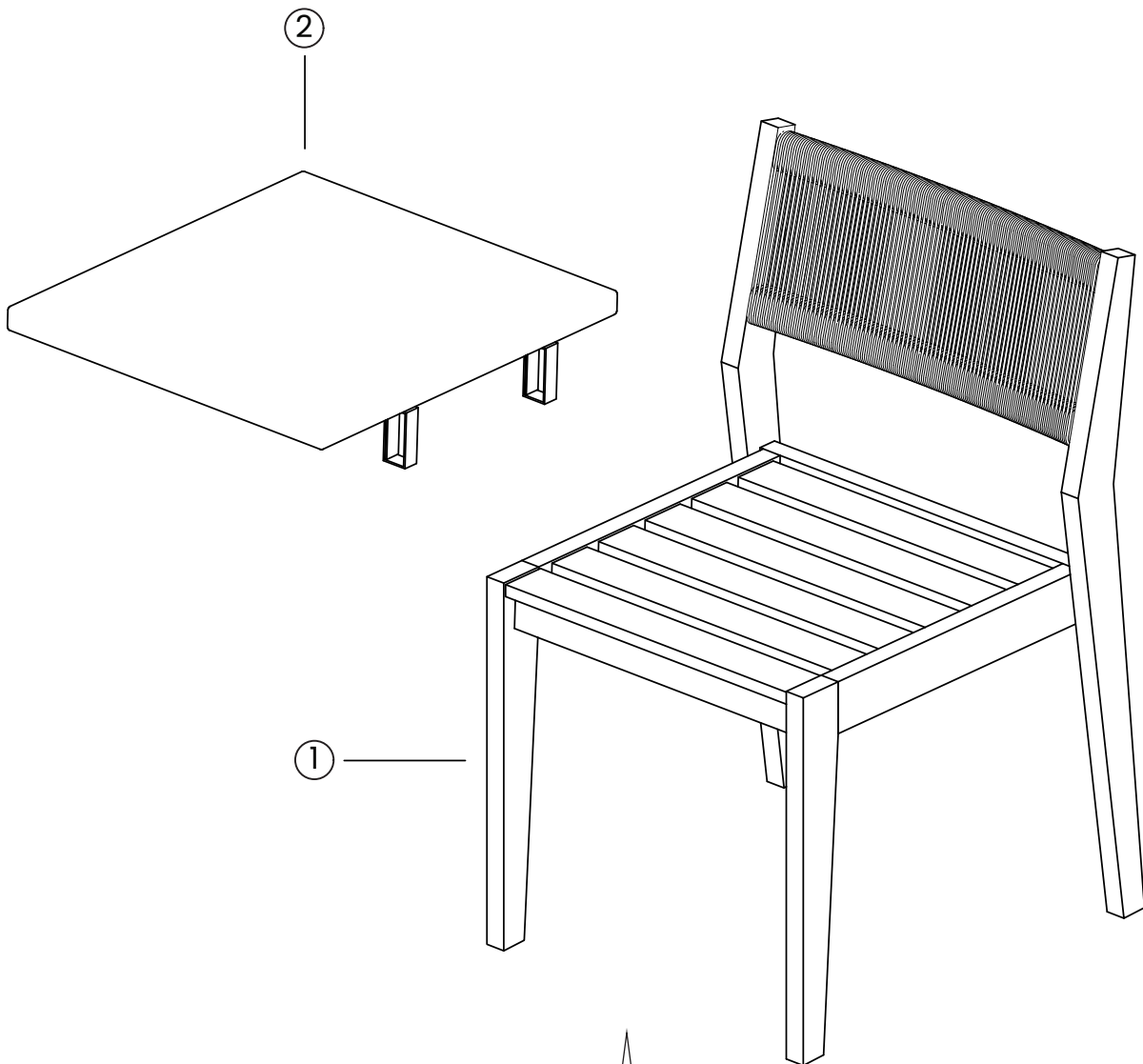

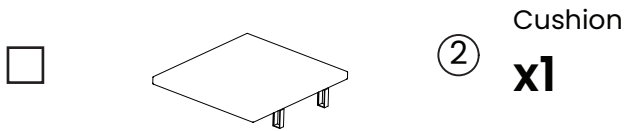
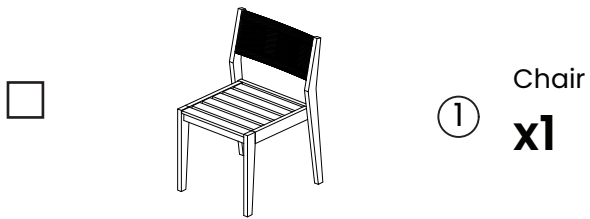

 Batch code label is located at the bottom side the seater.

Parts



 There are inner box(es) that include components required to complete this assembly.

 Please do not completely tighten all the hardware, until each assembly step is complete.

 Before discarding the packaging, please use the checklist to ensure that you have all the parts required to assemble your product. Please kindly note you will need the original package if you want to return the product later.

 If parts are missing or damaged, we will gladly ship your replacements parts free of charge. Please contact us via www.castlery.com/contact-us.

IMPORTANT: 2 persons needed for assembly.
This will help to minimize potential damage to the product or injury to persons during assembly.

Illustrations in this guide are for reference only and may be slightly different from the actual object.

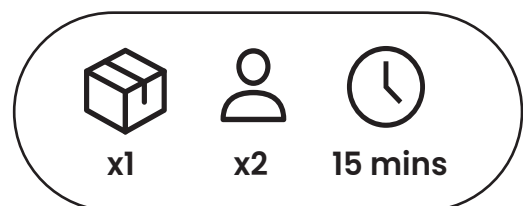

Step 1

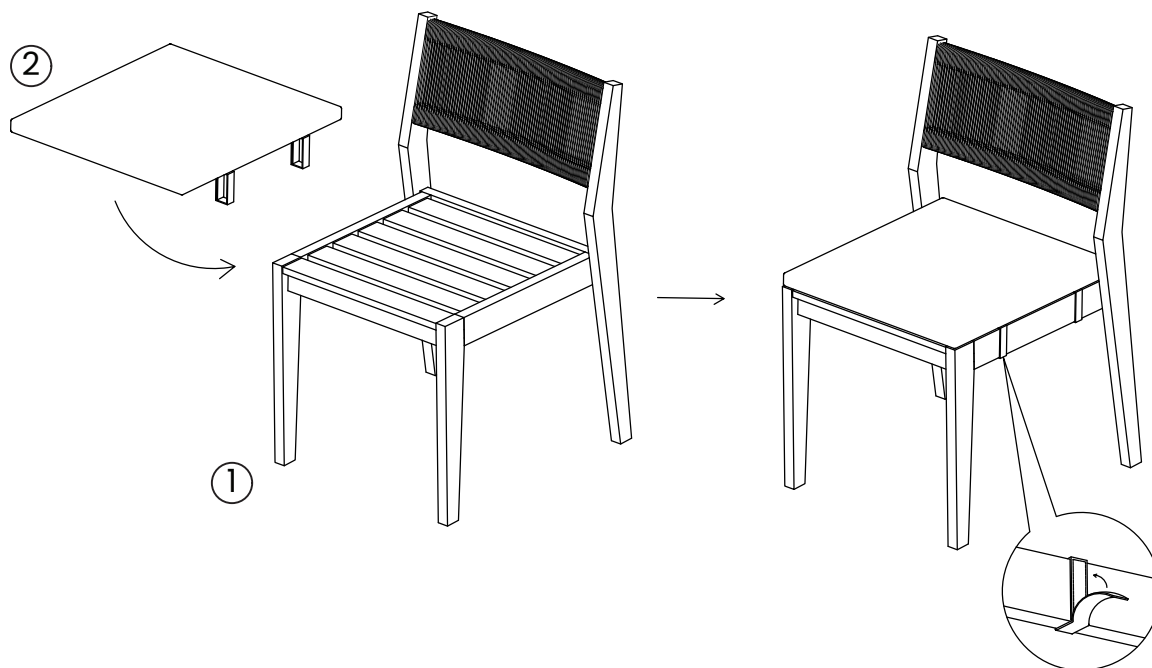

Stacking Instruction

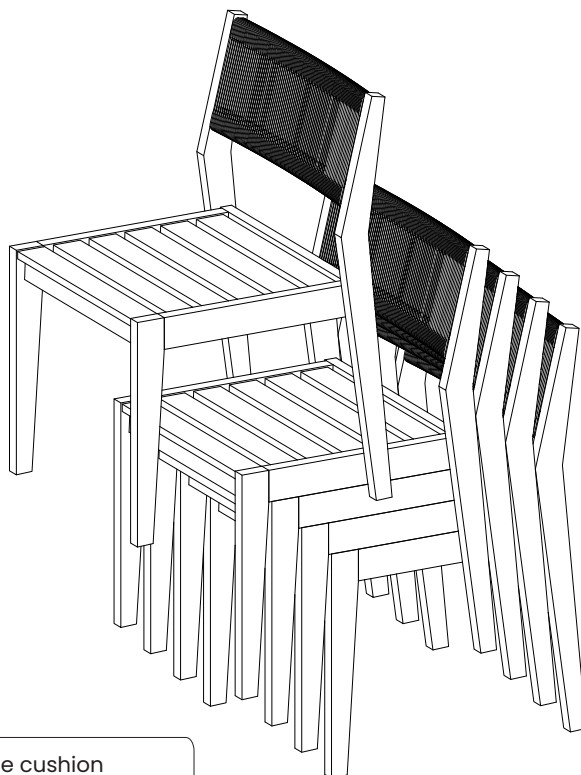

Please remove the cushion
when you want to stack the chair.

Maximum stacking is 4 chairs

Finished!

Congratulations, we're almost there!

Please perform the following checks:

Always lift your Castlery product when moving it to your preferred location. Levelers (if any) may slant if you drag your product.

Finally, clean the product with a damp cloth.

You're all set! Enjoy your new living space, thanks to the addition of your Castlery product.

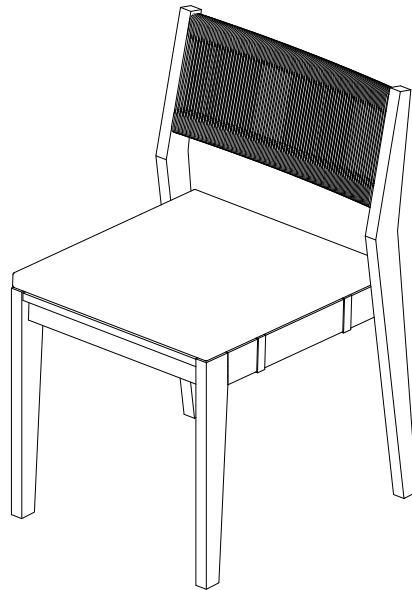

Note: Your actual product may have minor size differences due to manual measurements.

Care

Instructions

Your furniture, if treated with respect and love, will last you a long time. Each piece requires light maintenance to maximise its longevity.

Do's:

• **General**

1. Use a wet cloth with mild soap and water solution to wipe the furniture if needed. Rinse with water and leave it to dry.
2. Blot spills immediately with a clean, absorbent cloth. Use coasters or placemats where possible to prevent discolouration of the surface, and do not leave glassware on the table under direct sunlight.
3. As with all Castlery outdoor furniture, we recommend using our custom furniture covers when items are not in use; furniture, cushions and covers should be clean and completely dry before putting on the outdoor covers.
4. Store the furniture in a dry, protected area during harsh weather or when not in use to prolong the lifespan of the product.

• **Wood Frame**

1. Screws and bolts may loosen over time. Please check them regularly to tighten it when necessary.
2. Clean the teak wood regularly with a dry, soft cloth.
3. To maintain the glamour and original colour of the teak wood for a longer period, we recommend to lightly sandpaper the surface and apply Golden Care® Teak Protector every 6 to 12 months if the item is in full sun, or every 2 to 3 years if it is under cover (depends on exposure and use). Application is very easy and can be done with a microfibre cloth or a brand-new dish sponge. Make sure teak is completely dry and free of dust prior to application.
4. In addition to the Golden Care® Teak Protector, we suggest using Golden Care® Teak & Hardwood Shield for added protection against moisture, mould, mildew and food/ drinks stains. Treatment can be done twice a year depending on exposure and use. Tabletops should be treated more frequently.

• **Cushions**

1. Vacuum with low suction power for regular fabric cleaning of the cushion from dust.
2. To remove stubborn stains on fabric, use fabric cleaner that is suitable for polyester fabric and brush away with a sponge and water. Cushion covers are removable for easy cleaning. Do not machine wash or tumble dry.
3. If cushions get wet, tip them on their sides with the zipper facing down and unzipped to ensure that all water drains.

Care

Instructions

4. To extend lifespan of your cushions, keep them free of dirt and foliage. We suggest storing it inside or under a covered area in case of bad weather, extreme heat or when not in use. To prevent mildew, stand cushions on one end and let them air dry completely before storing.
5. Do note that the cushion fabric is water repellent and not waterproof. Extended exposure to sunlight and extreme weather conditions could result in discolouration and damage of the cushions.

Don'ts :

1. Do not use silicone-based polishes.
2. Do not use abrasive cleaners that may damage the finishes and treatment.
3. Avoid letting water or any forms of liquid stand on the surface of the teak wood and cushions.
4. Avoid using high pressure cleaners.
5. Avoid moving the furniture in between extreme conditions of temperature and humidity, such as from outdoor under the sun to indoor air-conditioned room, since wood will crack naturally when adapting to these environmental changes.

Natural Characteristics of Teak:

1. Tiny fissures or cracks may develop if there are changes in humidity and temperature. This is unavoidable and occurs naturally in solid wood furniture.
2. Natural wood knots, imperfections as well as wood grain and colour variations are to be expected for natural teak wood.
3. Teak will naturally turn to silver grey patina colour if left untreated and left outdoors. To extend the lifetime appearance of the original teak colour, cover the furniture when it is completely dry, or store indoors in a dry and non-heated area during winter and inclement weather.
4. It is normal for solid teak wood to expand and contract with time and changes in weather (temperature and humidity).
5. Teak produces natural oils, hence it can cause a stain on the light coloured fabric cover after prolonged contact.

Follow the care instructions and look after your furniture. In return, your furniture will look after you.