

ONE CONCEPT

Billardtisch

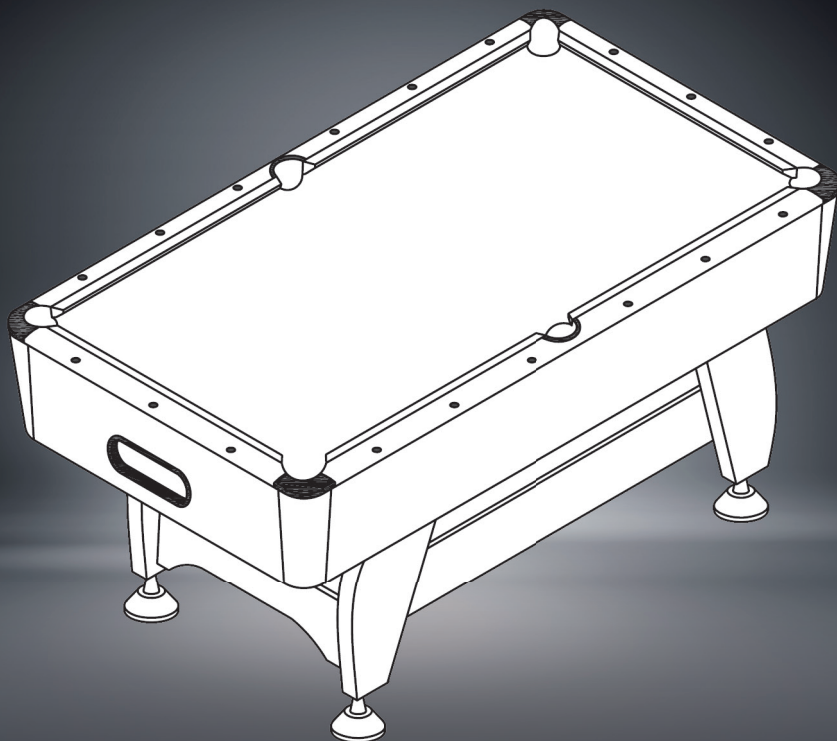









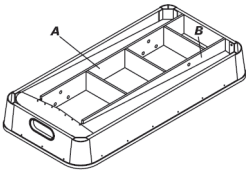

10026372 10026373 10026374 10030270 10030271

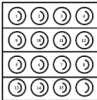
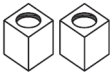
Sehr geehrter Kunde,

wir gratulieren Ihnen zum Erwerb Ihres Gerätes. Lesen Sie die folgenden Hinweise sorgfältig durch und befolgen Sie diese, um möglichen Schäden vorzubeugen. Für Schäden, die durch Missachtung der Hinweise und unsachgemäßen Gebrauch entstehen, übernehmen wir keine Haftung.

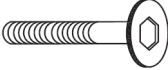
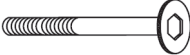
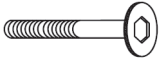
Lieferumfang

#	Bild	Bezeichnung	Menge
		Hauptteil Seitenleiste A Seitenleiste B	1 1 1
P2		Bein	4
P3		Endplatte	2
P4		Seiten-Paneel	2
A1		Bürste	1
A2		Billardkugel-Set	Set
A3		Kreide	2

#	Bild	Bezeichnung	Menge
A4		Queue	2
A5		Dreieck	1
H1		Schraube 5/16" x 2¾"	12
H2		Schraube ¼" x 3"	8
H3		Schraube ¼" x 2¼"	8
H4		Inbusschlüssel	1
H5		5/16" Unterlegscheibe	12
H6		¼" Unterlegscheibe	16
H7		Fußstück	4

Montageanleitung

Schritt 1

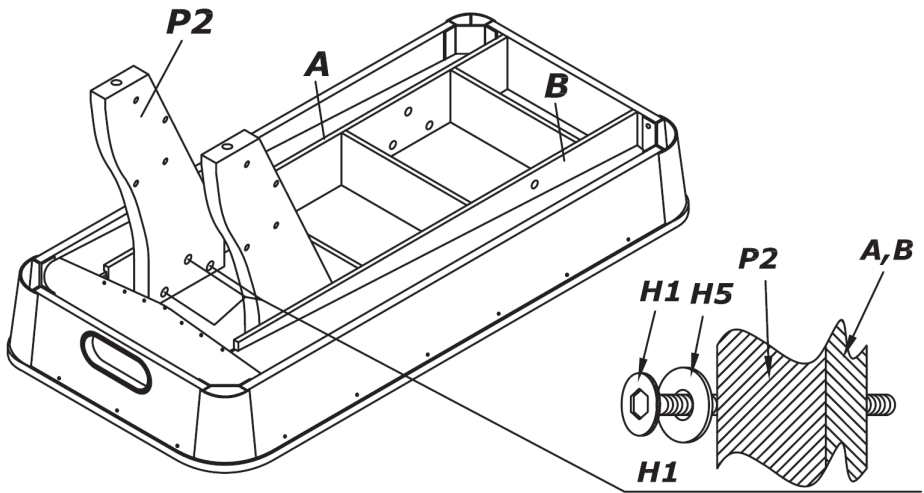

1. Legen Sie das Hauptteil flach mit der Oberseite auf den Boden. Nutzen Sie zur Vermeidung von Beschädigungen den Versandkarton als Unterlage.
2. Verschrauben Sie die Beine (P2) mit den H1-Schrauben und den passenden Unterlegscheiben (H5) in den Winkeln der Seitenleisten (vgl. Abbildung).

Schritt 2

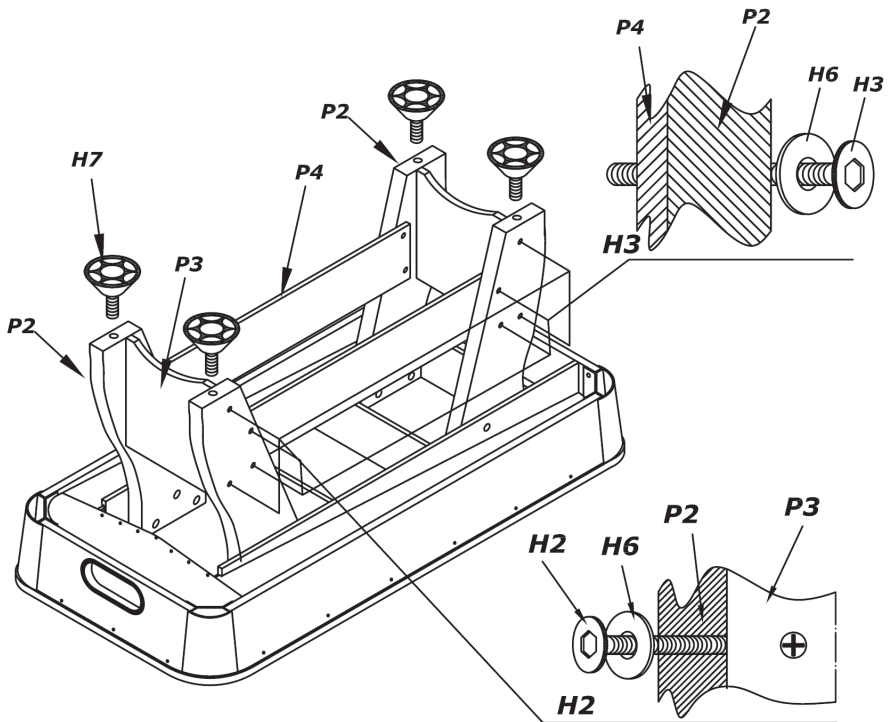

1. Montieren Sie die beiden Endplatten (P3) an die Innenseite der Beine. Benutzen Sie hierfür die $\frac{1}{4}$ "-Zoll-Schrauben (H2) sowie die Unterlegscheiben H6. (Die Gewinde sind bereits in die Beinstücke eingearbeitet).
2. Verschrauben Sie die Seiten-Paneele (P4) sowie die End-Paneele (P3) mit den INNENSEITEN der Beine (P2). Benutzen Sie hierfür die Schrauben H3 in Kombination mit den entsprechenden Unterlegscheiben (H6).
3. Schrauben Sie die Fußstücke (H7) in die Gewinde an den Unterseiten der Beine.





Vergewissern Sie sich, dass alle Schrauben fest angezogen sind. Stellen Sie den Tisch nun auf und nivellieren Sie den Tisch mit Hilfe einer Wasserwaage: Drehen Sie an den Fußstücken, bis die Platte perfekt ausbalanciert ist. Viel Spaß mit dem oneConcept Brighton!





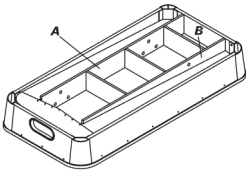

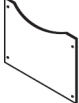
Hersteller: Chal-Tec GmbH, Wallstraße 16, 10179 Berlin, Deutschland.

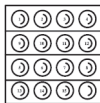
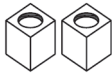
Dear Customer,

Congratulations on purchasing this equipment. Please read this manual carefully and take care of the following hints to avoid damages. Any failure caused by ignoring the mentioned items and cautions mentioned in the instruction manual are not covered by our warranty and any liability.

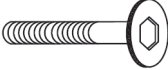
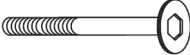
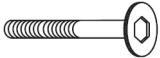
Packing Content

#	Picture	Name	Amount
		Main assembly Long Rail A Long Rail B	1 1 1
P2		Legs	4
P3		End panels	2
P4		Side panels	2
A1		Brush	1
A2		Billiard balls	Set
A3		Chalk	2

#	Picture	Name	Amount
A4		Cue	2
A5		Triangle	1
H1		Bolt 5/16" x 2¾"	12
H2		Bolt ¼" x 3"	8
H3		Bolt ¼" x 2¼"	8
H4		Tool	1
H5		5/16" Washer	12
H6		¼" Washer	16
H7		Leg levelers	4

Installation

Step 1

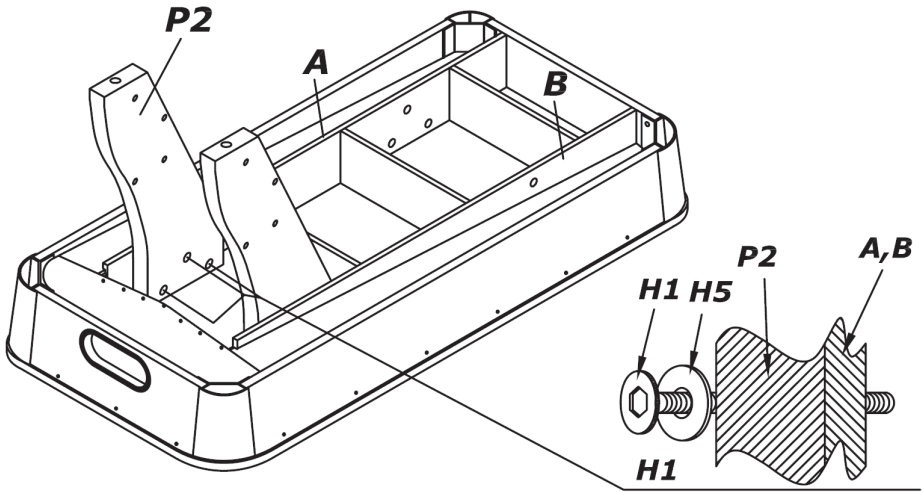

1. Place Main Assembly with the playing side on the ground. Take care the surface is even and clean. Underlay the shipping carton to avoid marks, scratches or other damage.
2. Use bolts (H1) and washers (H5) to attach the legs (P2) to the long rails (A, B) as in above figure.

Step 2

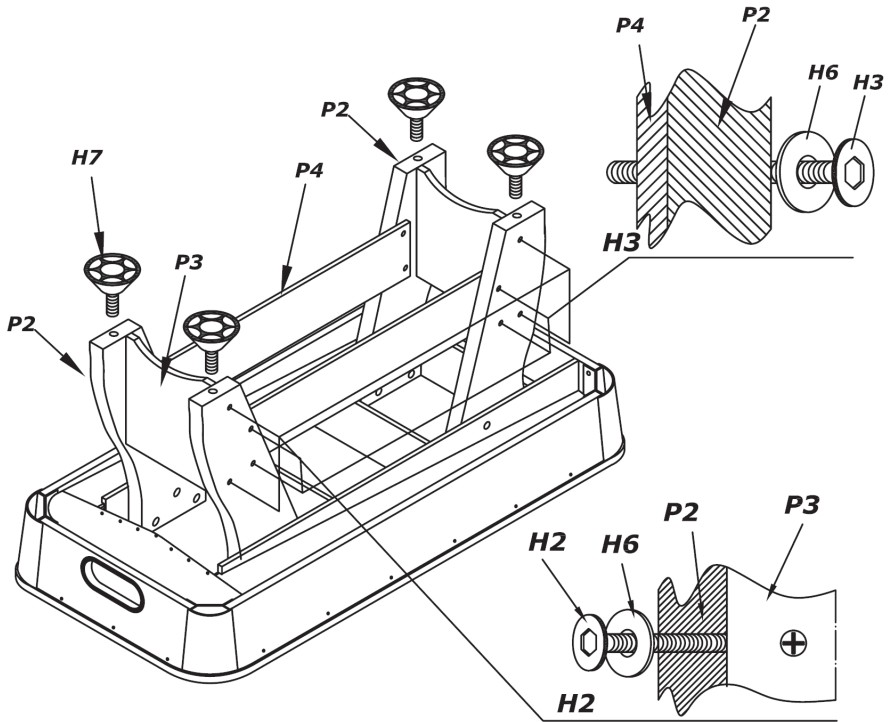

1. Attach the end leg panels (P3) to the inside surface of legs P2 using $\frac{1}{4}$ " bolts H2 and washers (H6). (The threaded barrel are pre-assembled in the end leg panels P3).
2. Attach the side leg panels (P3) and the end leg panels (P4) to the inside surfaces of the legs (P2) using bolts (H2) with fitting washers (H5).
3. Screw in the leg levelers into the legs as shown above.





Make sure all bolts are firmly attached. Put the billiard table on its feet and level it using a water level: turn the leveling feet in their thread until the table is perfectly balanced. Enjoy a match of billiard on your new oneConcept Brighton billiard table!





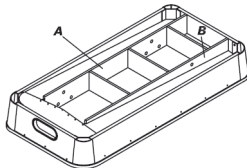

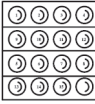
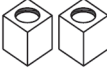

Producer: Chal-Tec GmbH, Wallstraße 16, 10179 Berlin, Deutschland.

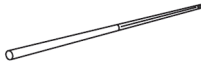
Cher client,

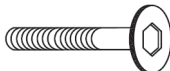
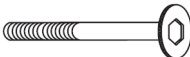
Toutes nos félicitations pour l'acquisition de ce nouvel appareil. Veuillez lire attentivement les instructions suivantes afin d'éviter d'éventuels dommages. Le fabricant ne saurait être tenu pour responsable des dommages dus au non-respect des consignes de sécurité et à la mauvaise utilisation de l'appareil.

Livraison

#	Schéma	Description	Quantité
		Pièce principale Planche latérale A Planche latérale B	1 1 1
P2		Pied	4
P3		Panneau d'extrémité	2
P4		Panneau latéral	2
A1		Brosse	1
A2		Jeu de boules de billard	Set
A3		Craie	2

#	Schéma	Description	Quantité
A4		Queue	2
A5		Triangle	1
H1		Vis 5/16" x 2 3/4"	12
H2		Vis 1/4" x 3"	8
H3		Vis 1/4" x 2 1/4"	8
H4		Clé Allen	1
H5		5/16" Rondelle plate	12
H6		1/4" Rondelle plate	16
H7		Support de pied	4

Guide de montage

Étape 1

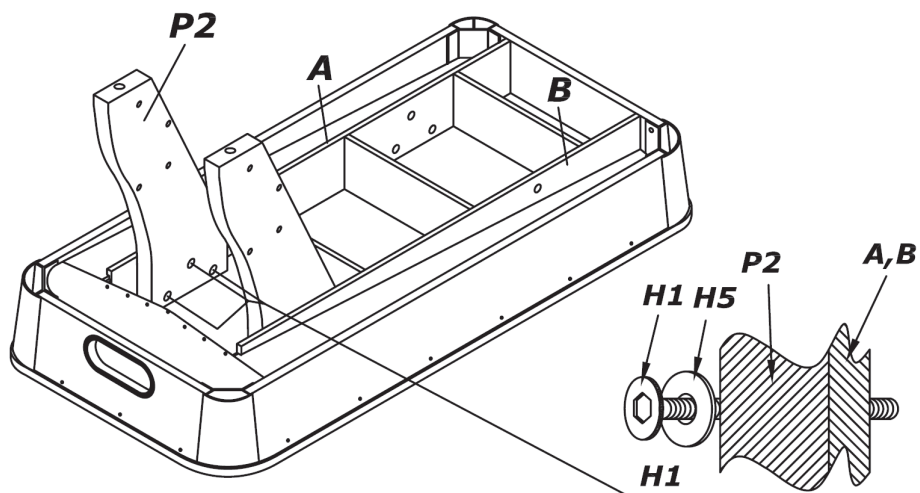

1. Posez la pièce principale à plat avec la face supérieure vers le sol. Pour éviter les dégâts utilisez le carton d'emballage comme support.
2. Vissez les pieds (P2) avec les vis H1 et des rondelles plates adaptées (H5) dans les angles des planches latérales (suivant le schéma).

Étape 2

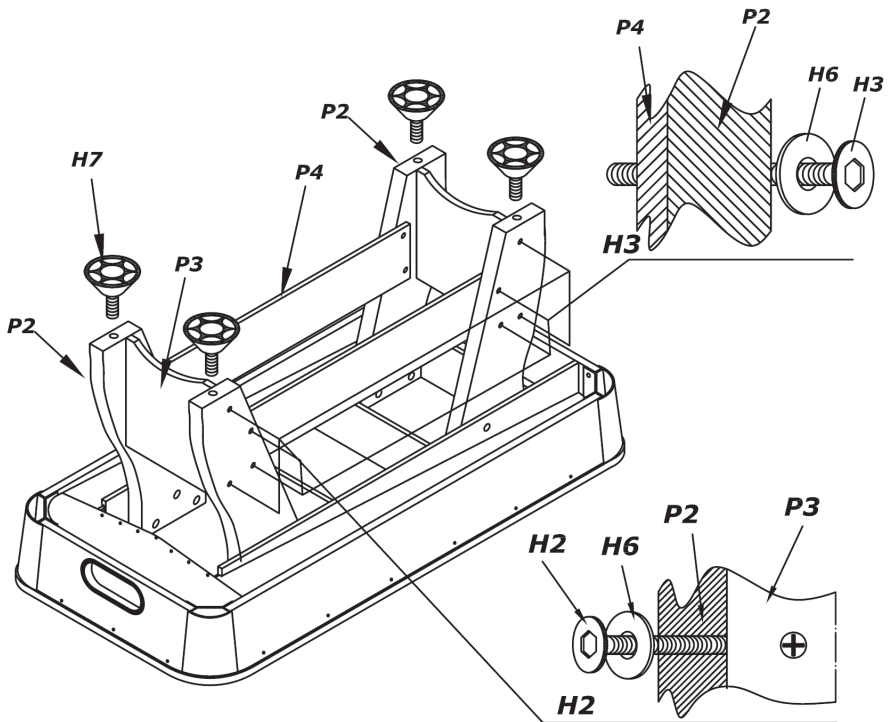

1. Assemblez les deux panneaux d'extrémité (P3) à l'intérieur des pieds. Utilisez pour cela les vis $\frac{1}{4}$ "-pouce (H2) ainsi que les rondelles plates H6. (les filetages sont incorporés aux pieds).
2. Vissez les panneaux latéraux (P4) ainsi que les panneaux d'extrémité (P3) sur le côté INTERIEUR des pieds (P2). Utilisez pour cela les vis H3 en association avec les rondelles (H6).
3. Vissez les supports de pieds (H7) dans les filetages sous les pieds.

Assurez-vous que toutes les vis sont bien serrées. Relevez maintenant la table et ajustez l'horizontalité à l'aide d'un niveau à bulles : vissez les supports de pieds jusqu'à ce que la table soit parfaitement équilibrée. Amusez-vous bien avec le oneConcept Brighton !

Fabricant : Chal-Tec GmbH, Wallstraße 16, 10179 Berlin, Allemagne.