



blumfeldt

## Sunwave

Sonnenliege

Sunbed

Cama Solar

Lit De Plage

Lettino

10028706 10028707 10028708





**Sehr geehrter Kunde,**

wir gratulieren Ihnen zum Erwerb Ihres Gerätes. Lesen Sie die folgenden Hinweise sorgfältig durch und befolgen Sie diese, um möglichen Schäden vorzubeugen. Für Schäden, die durch Missachtung der Hinweise und unsachgemäßen Gebrauch entstehen, übernehmen wir keine Haftung. Scannen Sie den folgenden QR-Code, um Zugriff auf die aktuellste Bedienungsanleitung und weitere Informationen rund um das Produkt zu erhalten:

**Dear Customer,**

Congratulations on purchasing this device. Please read the following instructions carefully and follow them to prevent possible damages. We assume no liability for damage caused by disregard of the instructions and improper use. Scan the QR code to get access to the latest user manual and more product information.

**Estimado cliente,**

Le felicitamos por la adquisición de este producto. Lea atentamente las siguientes instrucciones y sígalas para evitar posibles daños. No asumimos ninguna responsabilidad por los daños causados por el incumplimiento de las instrucciones y el uso inadecuado. Escanee el siguiente código QR para obtener acceso a la última guía del usuario y más información sobre el producto.

**Chère cliente, cher client,**

Toutes nos félicitations pour l'acquisition de ce nouvel appareil. Veuillez lire attentivement et respecter les instructions de ce mode d'emploi afin d'éviter d'éventuels dommages. Nous ne saurions être tenus pour responsables des dommages dus au non-respect des consignes et à la mauvaise utilisation de l'appareil. Scannez le QR-Code pour obtenir la dernière version du mode d'emploi et des informations supplémentaires concernant le produit.

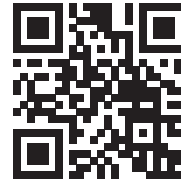
**Gentile cliente,**

La ringraziamo per aver acquistato il dispositivo. La preghiamo di leggere attentamente le seguenti istruzioni per l'uso e di seguirle per evitare possibili danni. Non ci assumiamo alcuna responsabilità per danni scaturiti da una mancata osservazione delle avvertenze di sicurezza e da un uso improprio del dispositivo. Scansionare il codice QR seguente, per accedere al manuale d'uso più attuale e per ricevere informazioni sul prodotto.



**Hinweis:** Das Maximal Gewicht des Benutzer liegt bei 110 kg.

**Note:** The maximum user weight is 110 kg.







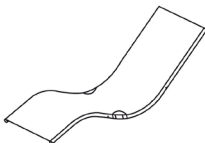

**Nota:** El peso máximo del usuario es de 110 kg.

**Remarque :** le poids maximal de l'utilisateur est de 110 kg.

**Nota:** il peso massimo dell'utente è di 110 kg.

## LIEFERUMFANG

Scope of delivery | Volumen de suministro | Contenu de la livraison |  
Dotazione di fornitura

A		x1	F		x4
B		x2	G		x4
C		x1	H		x2
D		x1	I		x2
E		x4			

# ZUSAMMENBAU

Assembly | Ensamblaje | Assemblée | Assemblaggio

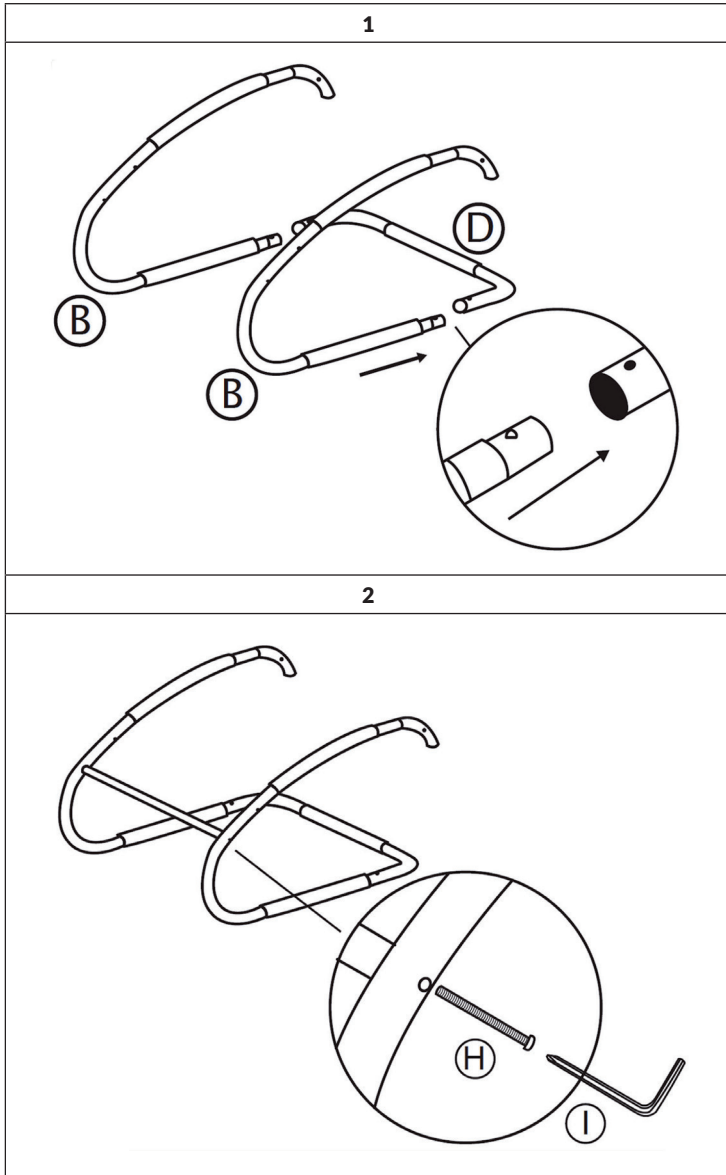

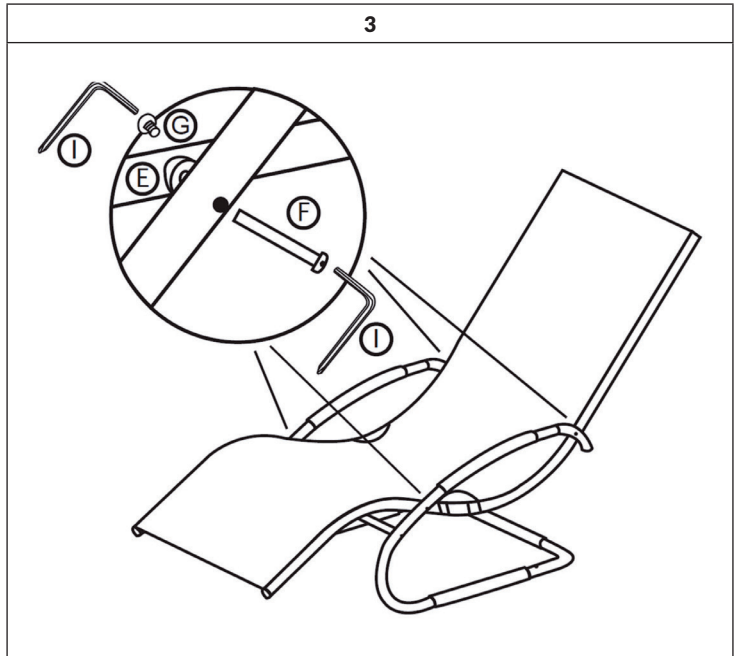

---

## HERSTELLER

---

### Manufacturer

Chal-Tec GmbH, Wallstraße 16, 10179 Berlin, Deutschland (Germany).

---

## IMPORTEUR FÜR GROSSBRITANNIEN

---

### Importer for Great Britain

Berlin Brands Group UK Limited  
PO Box 42  
272 Kensington High Street  
London, W8 6ND  
United Kingdom



