

Smoker

10029072











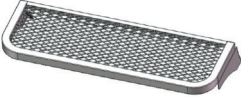

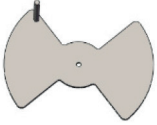
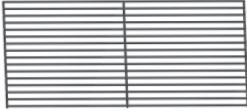

KLARSTEIN



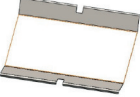

Sehr geehrter Kunde,

wir gratulieren Ihnen zum Erwerb Ihres Gerätes. Lesen Sie die folgenden Hinweise sorgfältig durch und befolgen Sie diese, um möglichen Schäden vorzubeugen. Für Schäden, die durch Missachtung der Hinweise und unsachgemäßen Gebrauch entstehen, übernehmen wir keine Haftung.

Lieferumfang

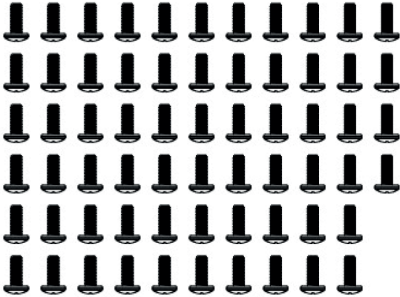
Nr.	Teil	Bild	Nr.	Teil	Bild
1	Basis (1x)		8	Smoker Rost (4x)	
2	Smoker Gehäuse (1x)		9	Fußhalter (2x)	
3	Kamin (1x)		10	Klammer (4x)	
4	Griff (1x)		11	Untere Ablage (1x)	
5	Deckel (1x)		12	Fuß links hinten (1x)	
6	Seitliche Brennkammer (1x)		13	Fuß links vorne (1x)	
7	Rost der seitlichen Brennkammer (2x)		14	Griff für die seitliche Brennkammer (3x)	

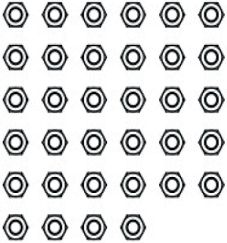
Nr.	Teil	Bild	Nr.	Teil	Bild
15	Vordere Ablage (1x)		24	Kohlerost der seitlichen Brennkammer (1x)	
16	Ölschale (1x)		25	Kohle-Tür (1x)	
17	Kohlepfanne (1x)		26	Luftklappe (1x)	
18	Kohlerost der Basis (1x)		27	Riegel (1x)	
19	Rad (2x)		28	Fuß rechts hinten (1x)	
20	Achse (1x)		29	Fuß rechts vorne (1x)	
21	Basis Deckel (1x)		30	Thermometer (2x)	
22	Deckel der seitlichen Brennkammer (1x)		31	Kohlepfanne der seitlichen Brennkammer (1x)	
23	Basis Grillrost (3x)		32	Haken für die Ölschale (1x)	

 <p>M6*15 (64x) Schraube</p>	 <p>Mutter M10 (2x)</p>	 <p>M6 (34x) Mutter</p>
 <p>Schraube M6*10 (1x)</p>		

Zusammenbau

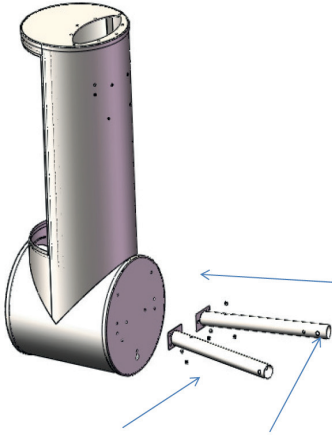
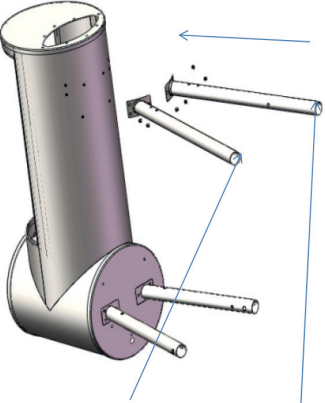
 <p>Fuß links vorn Fuß links hinten</p>	 <p>Fuß rechts vorne Fuß rechts hinten</p>
<p>1. Schrauben Sie die Füße mit mit einer M6*15 Schraube und einer M6*15 Mutter an.</p>	<p>2. Schrauben Sie die Füße mit mit einer M6*15 Schraube und einer M6*15 Mutter an.</p>

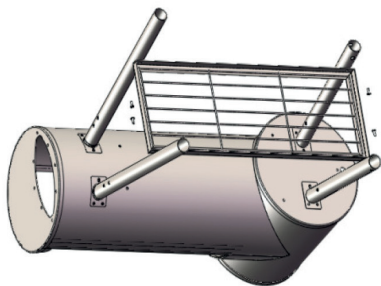

3. Befestigen Sie die untere Ablage mit M6*15 Schrauben.

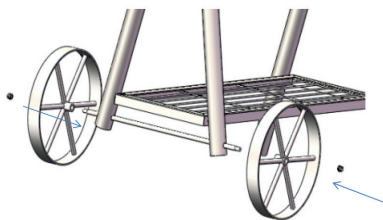

4. Befestigen Sie die Achse und die Räder mit den M10 Schrauben.



5. Befestigen Sie die Fußhalter mit M6*15 Schrauben.

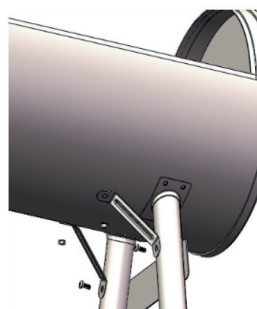

6. Befestigen Sie die Klammern mit M6*15 Schrauben und M6 Muttern.

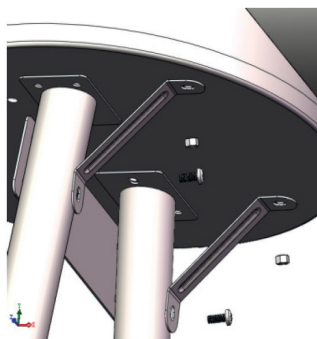

7. Befestigen Sie die Klammern mit M6*15 Schrauben und M6 Muttern.

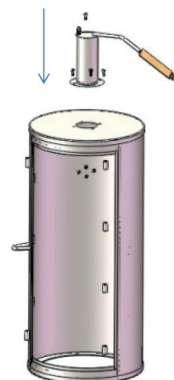

8. Befestigen Sie den Kamin mit M6*15 Schrauben und M6 Muttern.

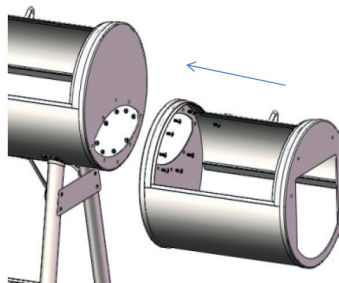

9. Befestigen Sie die seitliche Brennkammer mit M6*15 Schrauben.

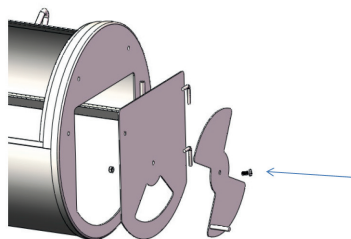

10. Befestigen Sie die Kohletür und die Luftklappe mit M6*15 Schrauben und M6 Muttern.

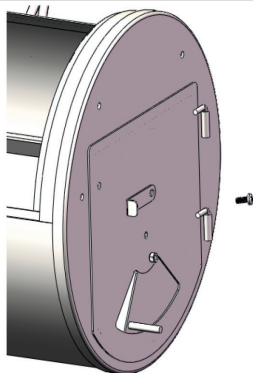

11. Befestigen Sie den Riegel mit der M6*10 Schraube.

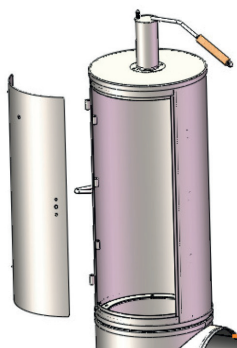

12. Befestigen Sie den Smoker-Deckel.



13. Befestigen Sie den Griff mit einer M10 Mutter.

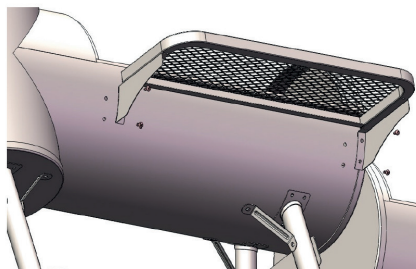

14. Befestigen Sie die vordere Ablage mit M6*15 Schrauben und M6 Muttern.

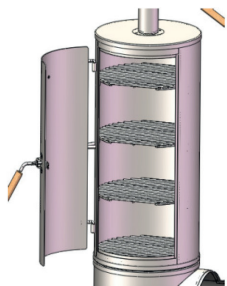

15. Setzen Sie die Grillroste in den Kamin.

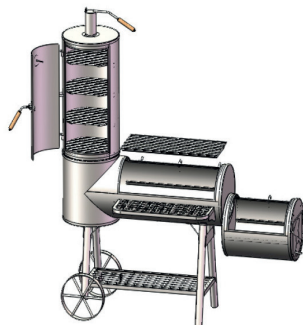

16. Setzen Sie die Kohlepfanne und den Kohlerost in die Basis ein.

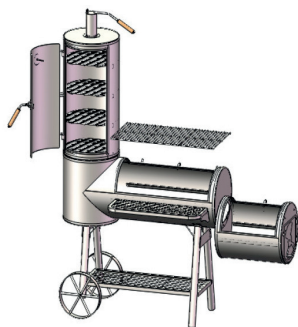

17. Setzen Sie den Grillrost in die Basis ein.

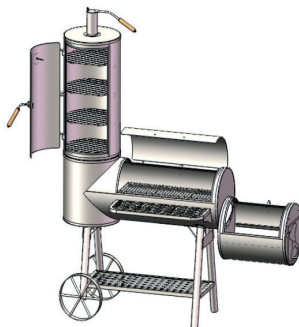

18. Bringen Sie den Deckel an der Basis an.

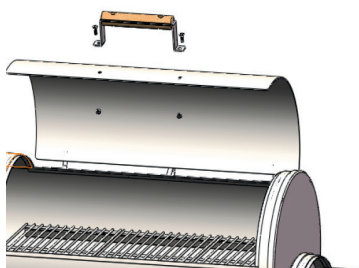

19. Befestigen Sie den Griff mit M6*15 Schrauben und M6 Muttern am Deckel.

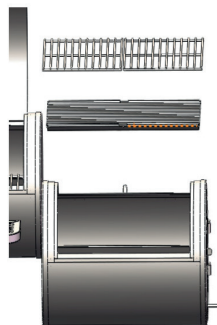

20. Setzen Sie die Kohlepfanne und den Grillrost in die seitliche Brennkammer ein.

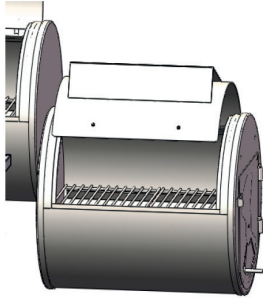

21. Bringen Sie den Deckel der seitlichen Brennkammer an.

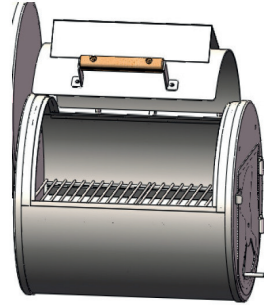

22. Bringen Sie den Griff mit M6*15 Schrauben und M6 Mutter an.

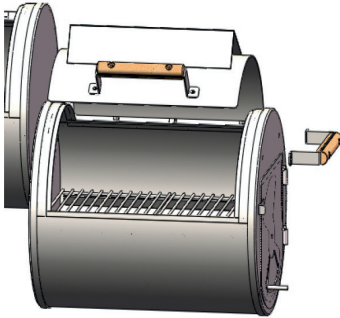

23. Bringen Sie den seitlichen Griff mit M6*15 Schrauben und M6 Mutter an.

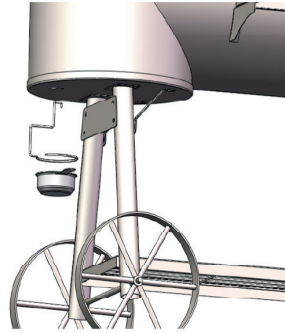

24. Befestigen Sie Ölschale und den Haken.

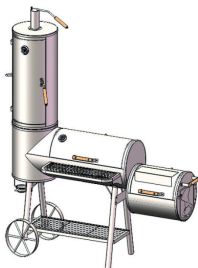



25. Befestigen Sie zum Schluss die Thermometer.







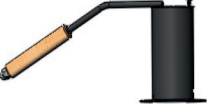



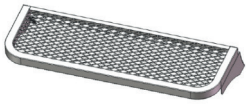

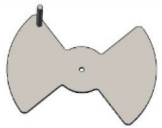

Hersteller: Chal-Tec GmbH, Wallstraße 16, 10179 Berlin, Deutschland.

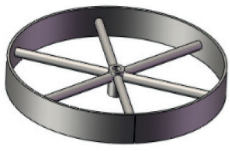

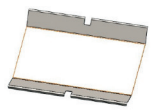

Dear Customer,

Congratulations on purchasing this equipment. Please read this manual carefully and take care of the following hints to avoid damages. Any failure caused by ignoring the mentioned items and cautions mentioned in the instruction manual are not covered by our warranty and any liability.

Accessory

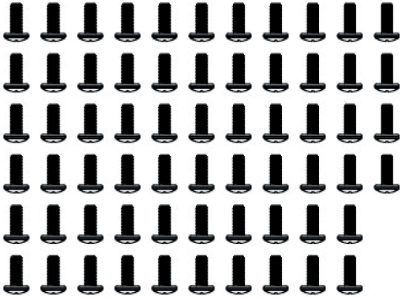
No	Part	Picture	No	Part	Picture
1	Main body (1x)		8	Smoker Grid (4x)	
2	Smoker Body (1x)		9	Foot Bracket (2x)	
3	Chimney (1x)		10	Body Bracket (4x)	
4	Handle (1x)		11	Bottom Rack (1x)	
5	Smoker Lid (1x)		12	Left Back Foot (1x)	
6	Side Box (1x)		13	Left Front Foot (1x)	
7	Side Box Grid (2x)		14	Side Box Handle (3x)	

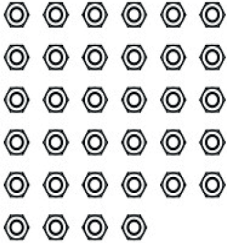
No	Part	Picture	No	Part	Picture
15	Front Plate (1x)		24	Side Box Charcoal Grid (1x)	
16	Oil cup (1x)		25	Charcoal Door (1x)	
17	Main Body Charcoal Pan (1x)		26	Damper (1x)	
18	Main Body Charcoal Grid (1x)		27	Flap Buckle (1x)	
19	Wheel (2x)		28	Right Back Foot (1x)	
20	Axle (1x)		29	Right Front Foot (1x)	
21	Main Body Lid (1x)		30	Thermometer (2x)	
22	Deckel der seitlichen Brennkammer (1x)		31	Side Box Charcoal pan (1x)	
23	Main Body Grid (3x)		32	Oil Cup Hooks (1x)	

 <p>M6*15 (64x) Screw</p>	 <p>Locknut M10 (2x)</p>	 <p>M6 (34x) Locknut</p>
 <p>Screw M6*10 (1x)</p>		

Assembling

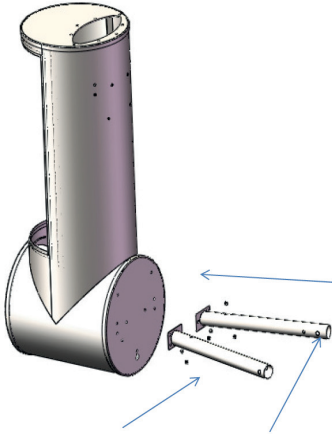
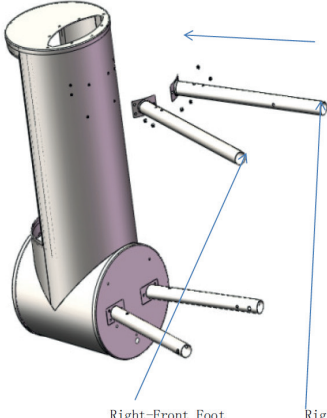
 <p>Left-Front Foot Left-Back Foot</p>	 <p>Right-Front Foot Right-Back Foot</p>
<p>1. Assemble the feet with M6*15 screw and M6 nut.</p>	<p>2. Assemble the feet with M6*15 screw and M6 nut.</p>

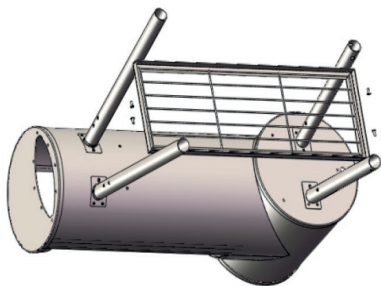

3. Assemble Bottom Rack with M6*15 screw.

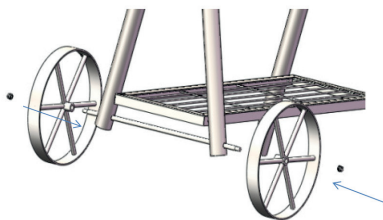

4. Assemble the Axle and the Wheel with M10 Lock Nut.

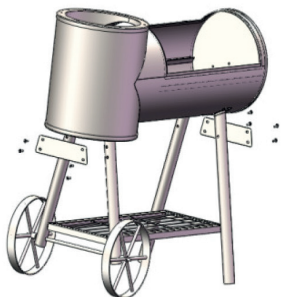

5. Assemble the Foot Bracket with M6*15 screw.

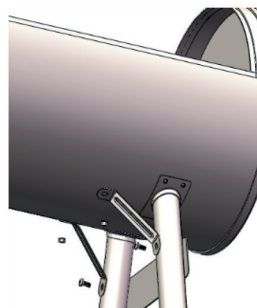

6. Assemble the Body Bracket with M6*15 screw and M6 nut.

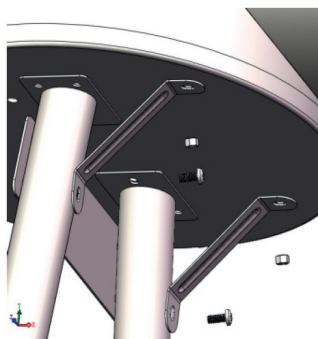

7. Assemble the Body Bracket with M6*15 screw and M6 nut.

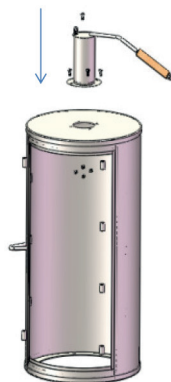

8. Assemble the Chimney with M6*15 screw and M6 nut.

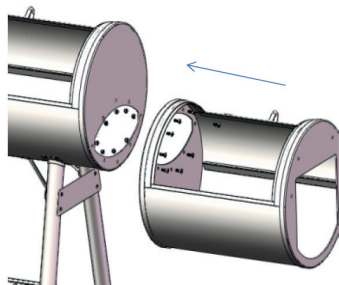

9. Assemble the side box with M6*15.

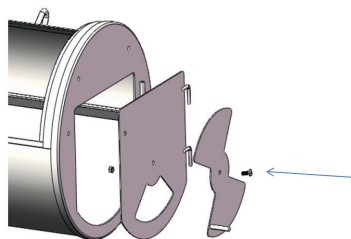

10. Assemble the Charcoal Door and the Damper with M6*15 screw and M6 nut.

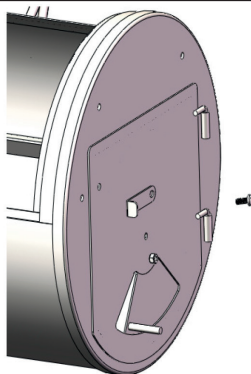

11. Assemble Damper Lock with M5 step screw.

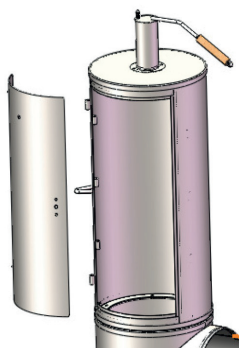

12. Assemble the Smoker Lid.



13. Assemble the handle on the smoker lid with M10 lock nut.

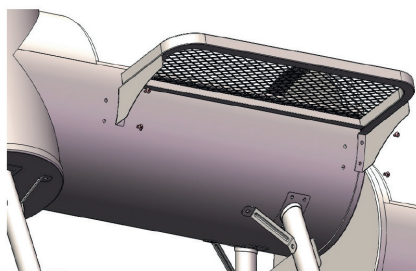

14. Assemble the Front Plate on the Body with M6*15 screw and M6 nut.

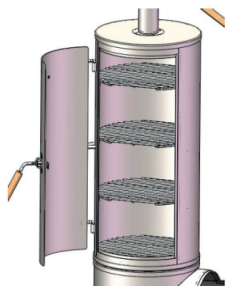

15. Assemble the Smoker Grid in the smoker body.

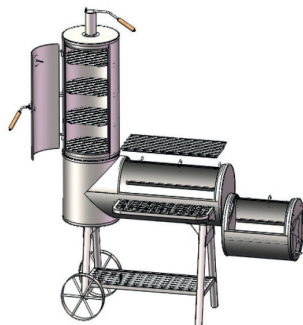

16. Assemble the charcoal pan and the charcoal grid.

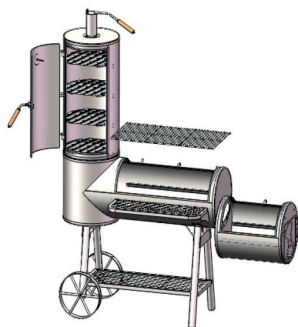

17. Assemble the grid in the main body.

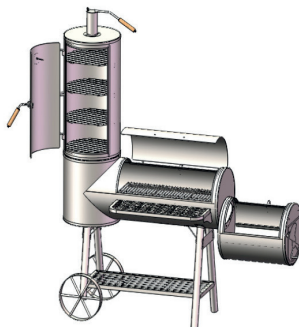

18. Assemble the main body door.

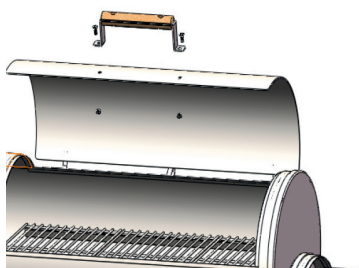

19. Assemble the handle on the main body lid with M6*15 screw and M6 nut.

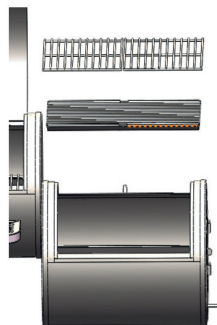

20. Assemble the charcoal grid, the charcoal pan and screw and M6 nut the cook grid in the side box.

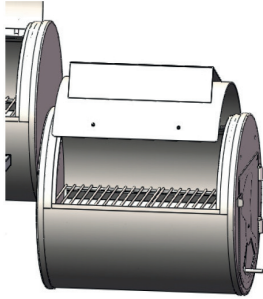

21. Assemble the side box lid.

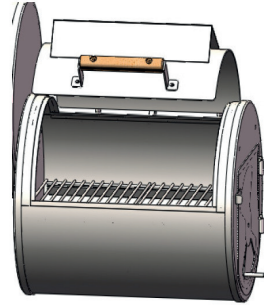

22. Assemble the handle on the side box lid with M6*15 screw and M6 nut.

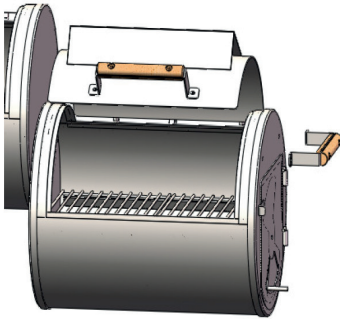

23. Assemble the handel on the side of the side box with M6*15 screw and M6 nut

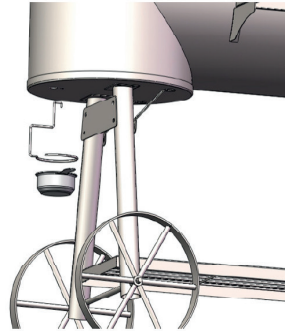

24. Assemble the Oil cup and Oil cup hook.

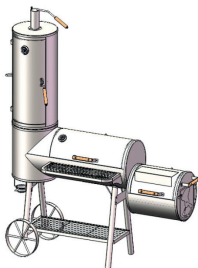

25. Assemble the thermometer and finish the assembling.











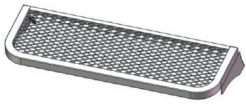



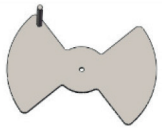

Producer: Chal-Tec GmbH, Wallstraße 16, 10179 Berlin, Germany.



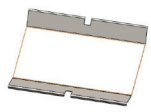

Estimado cliente:

Le felicitamos por la adquisición de este producto. Lea atentamente el siguiente manual y siga cuidadosamente las instrucciones de uso con el fin de evitar posibles daños. La empresa no se responsabiliza de los daños ocasionados por un uso indebido del producto o por haber desatendido las indicaciones de seguridad.

Contenido del paquete

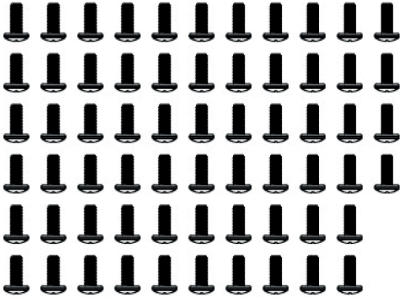
N°	Pieza	Imagen	N°	Pieza	Imagen
1	Base x1		8	Parrilla para ahumar x4	
2	Estructura del ahumador x1		9	Soporte de las patas x2	
3	Chimenea x1		10	Soporte de la estructura x4	
4	Manivela x1		11	Bandeja inferior x1	
5	Tapa del ahumador x1		12	Pata trasera izquierda x1	
6	Cámara lateral x1		13	Pata delantera izquierda x1	
7	Parrilla de la cámara lateral x2		14	Asa de la cámara lateral x3	

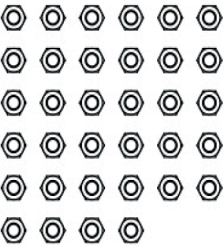
Nº	Pieza	Imagen	Nº	Pieza	Imagen
15	Bandeja delantera x1		24	Parrilla para el carbón de la cámara lateral x1	
16	Recipiente para el aceite x1		25	Puerta para introducir el carbón x1	
17	Recipiente para el carbón x1		26	Regulador de tiro x1	
18	Parrilla para el carbón de la base x1		27	Cierre x1	
19	Rueda x2		28	Pata trasera derecha x1	
20	Eje x1		29	Pata delantera derecha x1	
21	Tapa de la estructura principal x1		30	Termómetro x2	
22	Tapa de la cámara lateral x1		31	Recipiente para el carbón de la cámara lateral x1	
23	Parrilla de la base x3		32	Gancho para el recipiente de aceite x1	

 <p>Tornillos M6*15 (x64)</p>	 <p>Tuercas M10 (x2)</p>	 <p>Tuercas M6 (x34)</p>
 <p>Tornillo M6*10 (x1)</p>		

Montaje

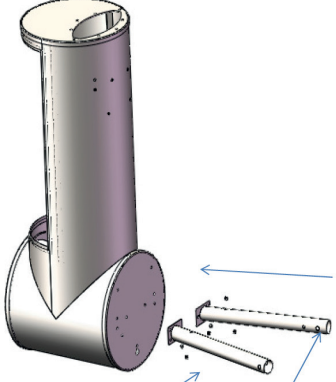
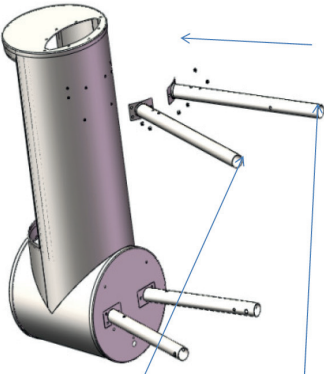
 <p>Pata delantera izquierda Pata trasera izquierda</p>	 <p>Pata trasera izquierda Pata trasera derecha</p>
<p>1. Monte las patas con tornillos M6*15 y tuercas M6*15.</p>	<p>2. Monte las patas con tornillos M6*15 y tuercas M6*15.</p>

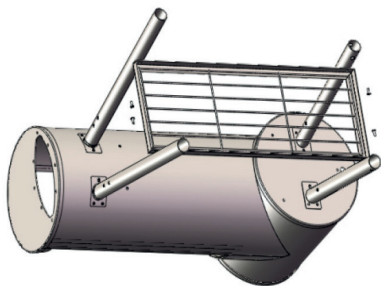

3. Fije la bandeja inferior con tornillos M6*15.

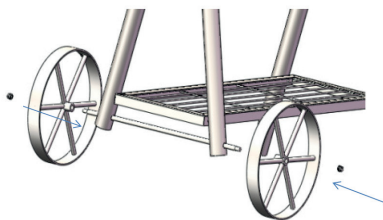

4. Fije el eje y las ruedas con tuercas M10.

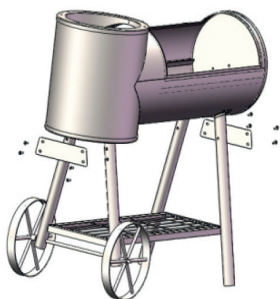

5. Fije el soporte de las patas con tornillos M6*15.

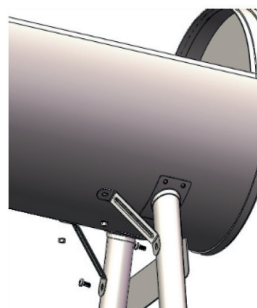

6. Fije el soporte de la estructura con tornillos M6*15 y tuercas M6.

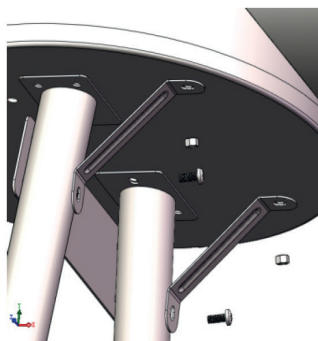

7. Fije el soporte de la estructura con tornillos M6*15 y tuercas M6.

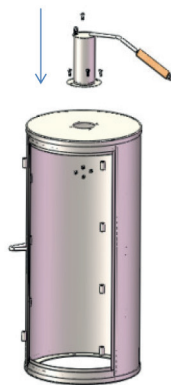

8. Fije la chimenea con tornillos M6*15 y tuercas M6.

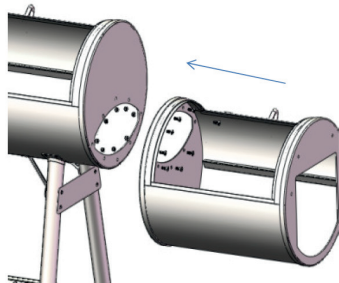

9. Fije la cámara lateral con tornillos M6*15.

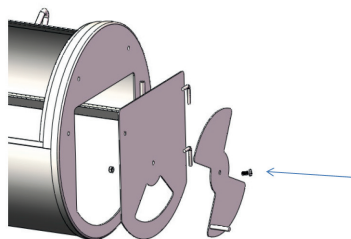

10. Fije la puerta para introducir el carbón y el regulador de tiro con tornillos M6*15 y tuercas M6.

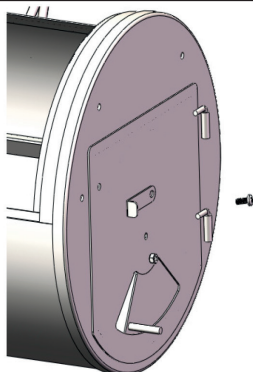

11. Fije el cierre con el tornillo M6*10.

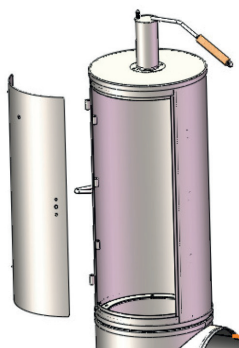

12. Encaje la tapa del ahumador.



13. Monte la manivela con una tuerca M10.

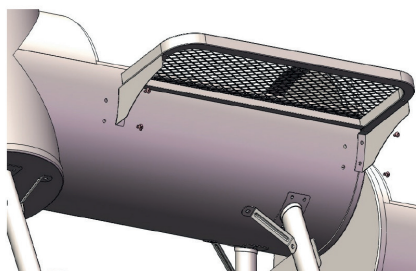

14. Fije la bandeja delantera con tornillos M6*15 y tuercas M6.

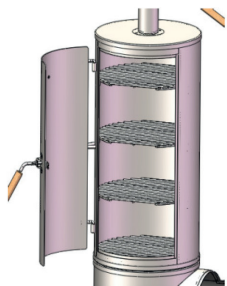

15. Coloque las parrillas dentro del ahumador.

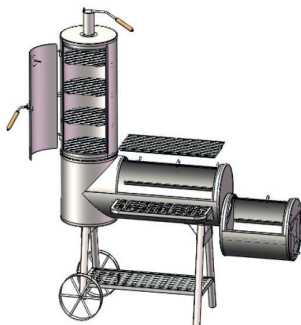

16. Coloque el recipiente y la parrilla para el carbón en la base.

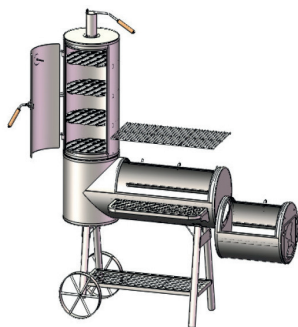

17. Coloque la parrilla en la base.

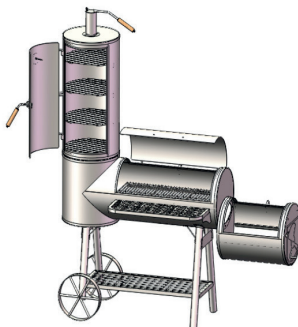

18. Monte la tapa en la base.

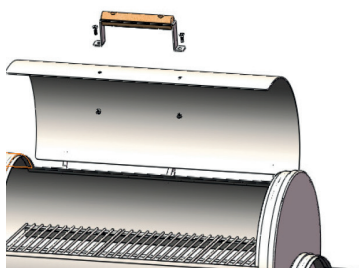

19. Fije el asa con tornillos M6*15 y tuercas M6 en la tapa principal.

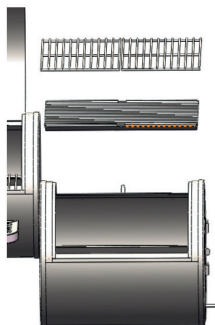

20. Coloque el recipiente y la parrilla para el carbón en la cámara lateral.

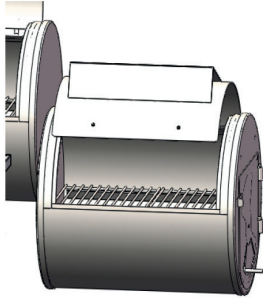

21. Monte la tapa de la cámara lateral.

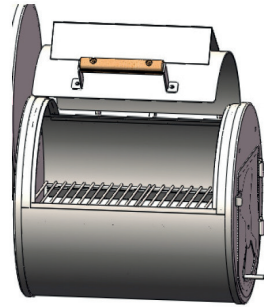

22. Monte el asa con tornillos M6*15 y tuercas M6.

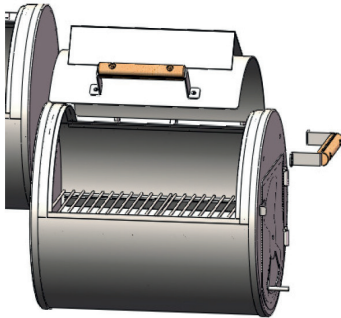

23. Monte el asa lateral con tornillos M6*15 y tuercas M6.



24. Coloque el recipiente y el gancho para el aceite.

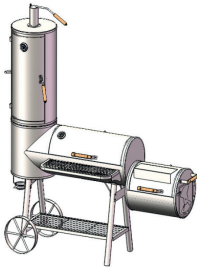

25. Por último, coloque el termómetro.











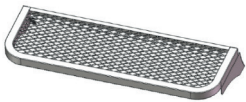

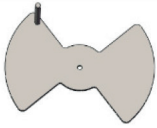
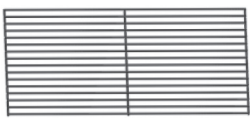

Fabricante: Chal-Tec GmbH, Wallstraße 16, 10179, Berlín (Alemania).



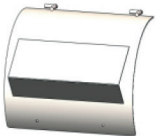
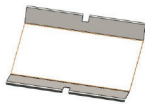

Chère cliente, cher client,

Toutes nos félicitations pour l'acquisition de ce nouvel appareil. Veuillez lire attentivement et respecter les instructions de ce mode d'emploi afin d'éviter d'éventuels dommages. Nous ne saurions être tenus pour responsables des dommages dus au non-respect des consignes et à la mauvaise utilisation de l'appareil.

Contenu de l'emballage

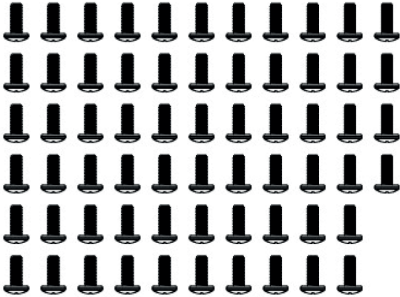
N°	Élément	Illustration	N°	Élément	Illustration
1	Chambre de combustion principale (1x)		8	Gril du fumeur (4x)	
2	Fumoir (1x)		9	Cale-pieds (2x)	
3	Cheminée (1x)		10	Fixation (4x)	
4	Poignée (1x)		11	Grille inférieure de rangement (1x)	
5	Couvercle (1x)		12	Pied arrière gauche (1x)	
6	Chambre latérale de combustion (1x)		13	Pied avant gauche (1x)	
7	Gril de la chambre latérale de combustion (2x)		14	Poignée de la chambre latérale de combustion (3x)	

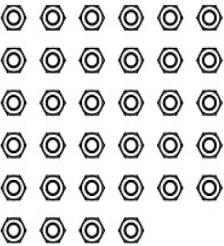
N°	Élément	Illustration	N°	Élément	Illustration
15	Grille avant de rangement (1x)		24	Grille à charbon de la chambre latérale de combustion (1x)	
16	Réceptif à huile (1x)		25	Porte à charbon (1x)	
17	Bac à charbon (1x)		26	Volet d'aération (1x)	
18	Grille à charbon de la chambre de combustion latérale (1x)		27	Loquet (1x)	
19	Roue (2x)		28	Pied arrière droit (1x)	
20	Essieu (1x)		29	Pied avant droit (1x)	
21	Couvercle de la chambre de combustion latérale (1x)		30	Thermomètre (2x)	
22	Couvercle de la chambre latérale de combustion (1x)		31	Bac à charbon de la chambre latérale de combustion (1x)	
23	Grill de la chambre de combustion latérale		32	Crochet pour le réceptif à huile (1x)	

 <p>Vis M6*15 (64x)</p>	 <p>Écrou M10 (2x)</p>	 <p>Écrou M6 (34x)</p>
 <p>Vis M6*10 (1x)</p>		

Assemblage

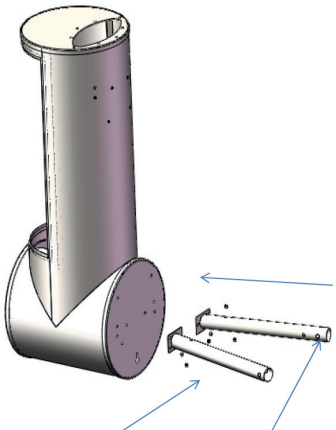
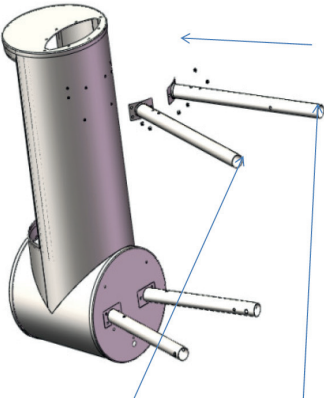
 <p>Pied avant gauche Pied arrière gauche</p>	 <p>Pied avant droit Pied arrière droit</p>
<p>1. Visser les pieds avec une vis M6*15 et un écrou M6*15.</p>	<p>2. Visser les pieds avec une vis M6*15 et un écrou M6*15.</p>

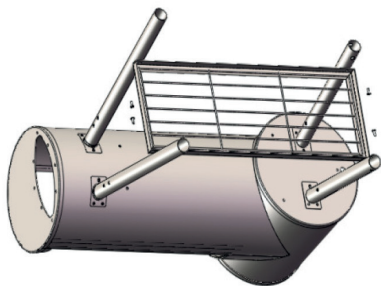

3. Fixer la grille inférieure de rangement avec des vis M6*15.

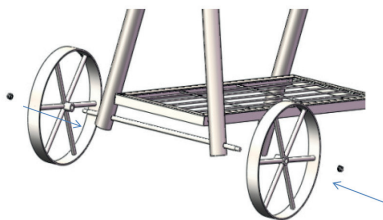

4. Fixer l'essieu et les roues avec des vis M10.



5. Fixer les cale-pieds avec des vis M6*15.

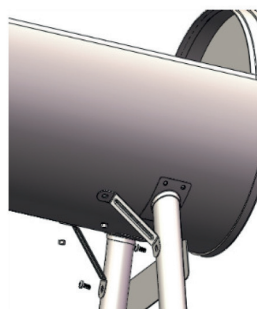

6. Installer les fixations avec des vis M6*15 et des écrous M6.

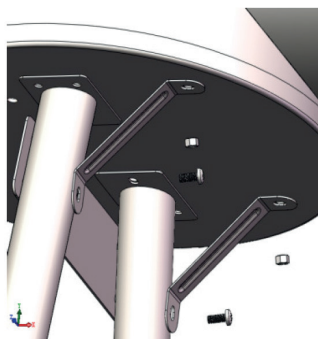

7. Installer les fixations avec des vis M6*15 et des écrous M6.

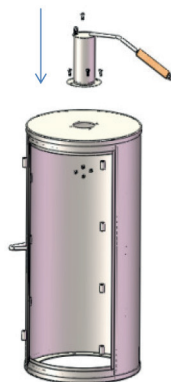

8. Fixer la cheminée avec des vis M6*15 et des écrous M6.

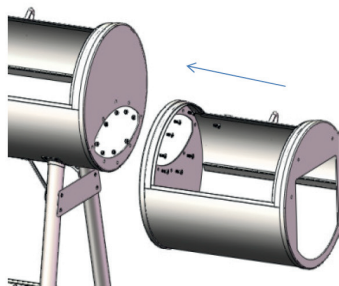

9. Fixer la chambre latérale de combustion avec des vis M6*15.

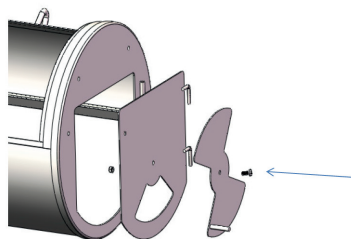

10. Fixer la porte à charbon et le volet d'aération avec des vis M6*15 et des écrous M6.

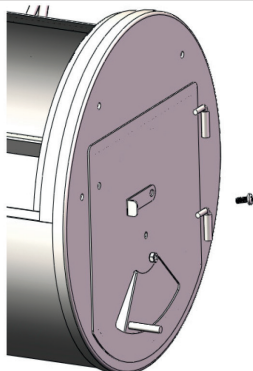

11. Fixer le loquet avec des vis M6*15.

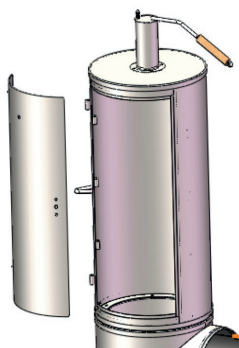

12. Fixer le couvercle du fumoir.



13. Fixer la poignée avec un écrou M10.

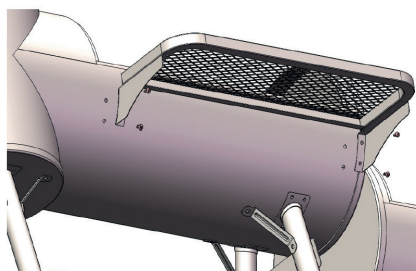

14. Fixer la grille avant de rangement avec des vis M6*15 et des écrous M6.

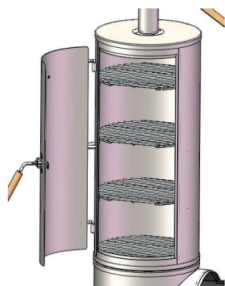

15. Installer les grils dans la cheminée.

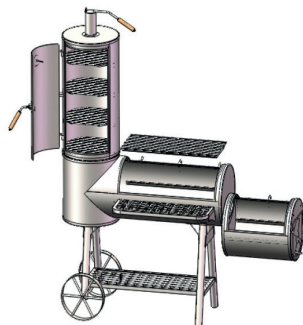

16. Installer le bac à charbon et la grille à charbon dans la chambre de combustion latérale.

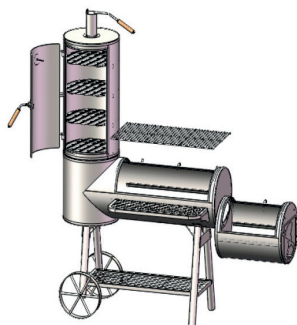

17. Installer le grill dans la chambre de combustion latérale.

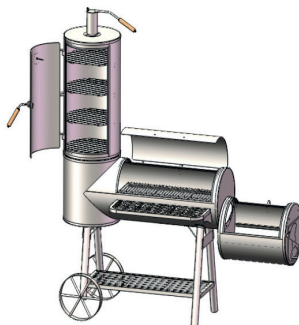

18. Monter le couvercle sur la chambre de combustion latérale.

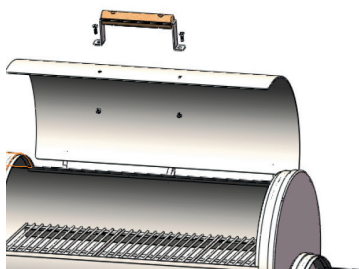

19. Fixer la poignée au couvercle avec des vis M6*15 et des écrous M6.

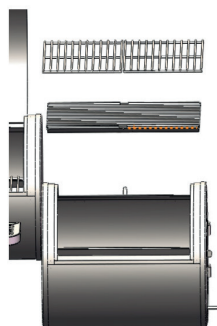

20. Installer le bac à charbon et le grill dans la chambre latérale de combustion.

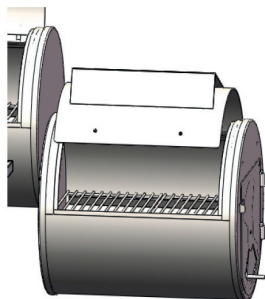

21. Monter le couvercle de la chambre latérale de combustion.

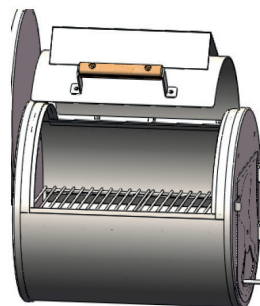

22. Fixer la poignée avec des vis M6*15 et des écrous M6.

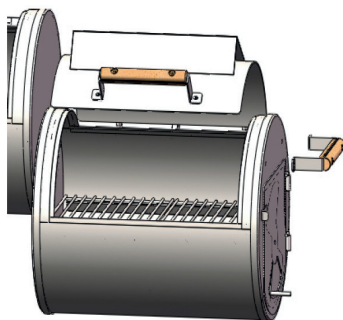

23. Fixer la poignée latérale avec des vis M6*15 et des écrous M6.



24. Fixer le récipient à huile et le crochet.

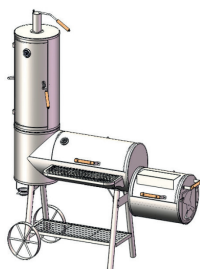

25. Pour finir, fixer les thermomètres.











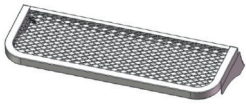



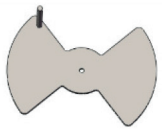

Fabricant : Chal-Tec GmbH, Wallstraße 16, 10179 Berlin, Allemagne.



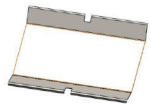

Gentile cliente,

La ringraziamo per aver acquistato il nostro dispositivo. La preghiamo di leggere attentamente le seguenti istruzioni e di seguirle per evitare eventuali danni. Non ci assumiamo alcuna responsabilità per danni derivati da una mancata osservazione delle avvertenze di sicurezza e da un uso improprio del dispositivo.

Consegna

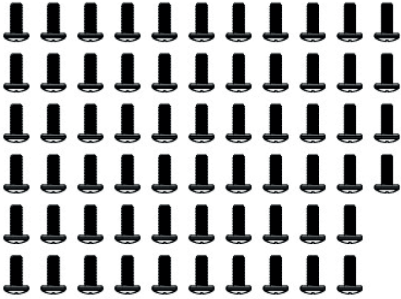
No.	Pezzo	Figura	No.	Pezzo	Figura
1	Unità principale (1x)		8	Griglia (4x)	
2	Unità affumicatore (1x)		9	Staffa piedi di appoggio (2x)	
3	Camino (1x)		10	Staffa unità principale (4x)	
4	Impugnatura (1x)		11	Griglia inferiore (1x)	
5	Coperchio (1x)		12	Piede di appoggio sinistro retro (1x)	
6	Camera affumicazione laterale (1x)		13	Piede di appoggio sinistro frontale (1x)	
7	Griglia della camera affumicazione laterale (2x)		14	Impugnatura camera affumicazione laterale (3x)	

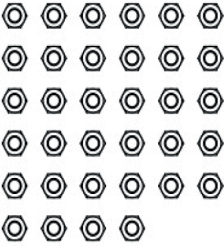
No.	Pezzo	Figura	No.	Pezzo	Figura
15	Ripiano frontale (1x)		24	Griglia a carbone della camera affumicazione laterale	
16	Recipiente olio (1x)		25	Sportello (1x)	
17	Vaschetta a carbone (1x)		26	Valvola aria (1x)	
18	Griglia a carbone dell'unità principale (1x)		27	Barra (1x)	
19	Ruota (2x)		28	Piede d'appoggio destro retro (1x)	
20	Asse (1x)		29	Piede d'appoggio destro frontale (1x)	
21	Coperchio unità principale (1x)		30	Termometro (2x)	
22	Coperchio della camera affumicazione laterale (1x)		31	Vaschetta a carbone della camera affumicazione laterale (1x)	
23	Griglia unità principale (3x)		32	Gancio del recipiente olio	

 <p>M6*15 (64x) Viti</p>	 <p>Dadi M10 (2x)</p>	 <p>M6 (34x) dadi</p>
 <p>Vite M6*10 (1x)</p>		

Montaggio

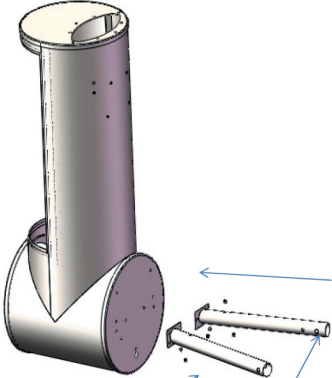
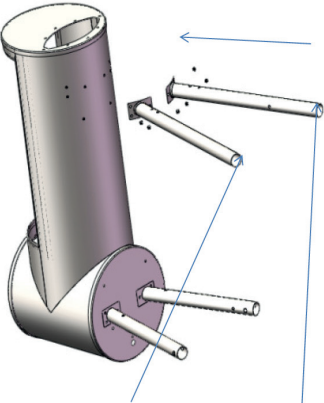
 <p>Piede sinistro frontale Piede sinistro retro</p>	 <p>Piede destro frontale Piede destro retro</p>
<p>1. Avvitare i piedi utilizzando una vite M6*15 e un dado M6*15.</p>	<p>2. Avvitare i piedi utilizzando una vite M6*15 e un dado M6*15.</p>

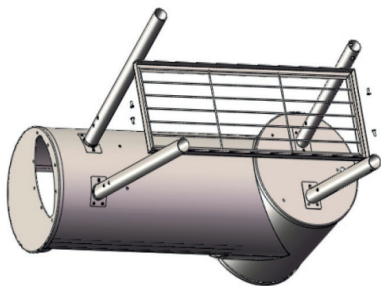

3. Fissare la griglia inferiore utilizzando le viti M6*15.

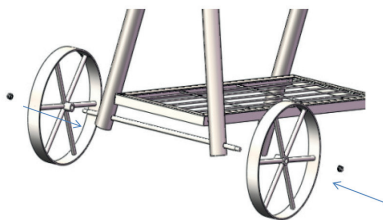

4. Fissare l'asse e le ruote utilizzando le viti M10.

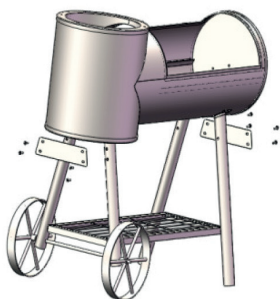

5. Fissare le staffe per i piedi di appoggio utilizzando le viti M6*15.

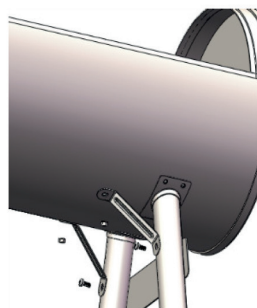

6. Fissare le staffe dell'unità principale utilizzando le viti M6*15 e dadi M6.

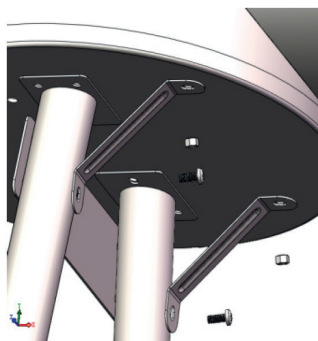

7. Fissare le staffe dell'unità principale utilizzando le viti M6*15 e i dadi M6.

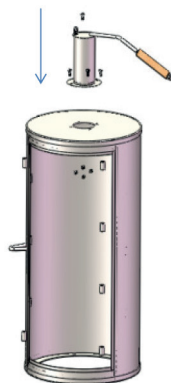

8. Fissare il camino utilizzando le viti M6*15 e i dadi M6.

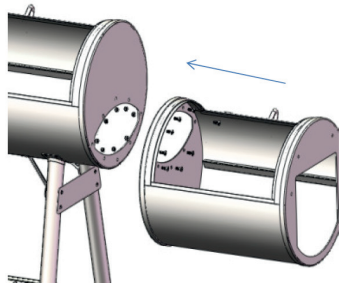

9. Fissare la camera di affumicazione laterale utilizzando le viti M6*15.

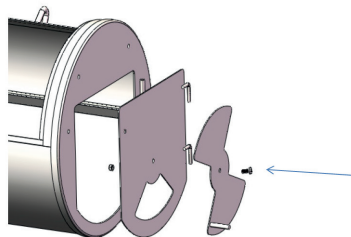

10. Fissare lo sportello e la valvola dell'aria utilizzando le viti M6*15 e i dadi M6.

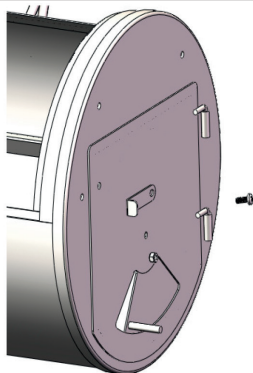

11. Fissare la barra utilizzando le viti M6*15.

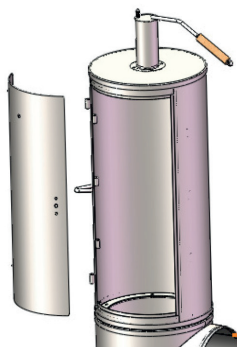

12. Fissare il coperchio.



13. Fissare l'impugnatura utilizzando un dado M10.

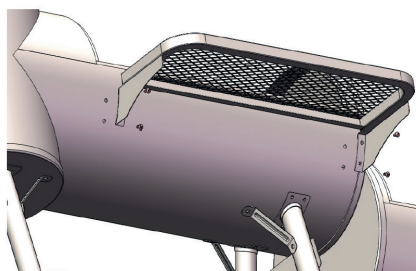

14. Fissare il ripiano frontale utilizzando le viti M6*15 e i dadi M6.

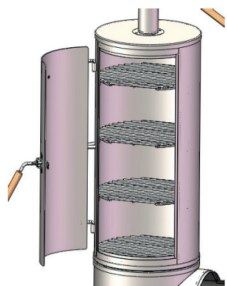

15. Inserire le griglie all'interno del camino.

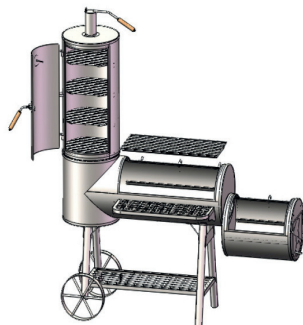

16. Inserire la vaschetta e la griglia a carbone.

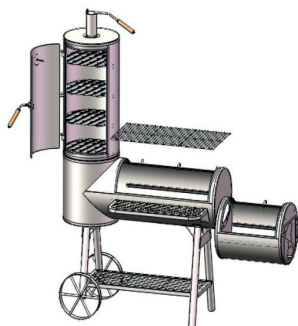

17. Inserire la griglia nell'unità principale.

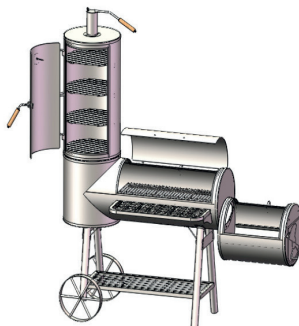

18. Assemblare il coperchio.

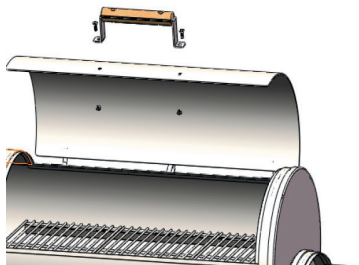

19. Fissare l'impugnatura al coperchio utilizzando le viti M6*15 e i dadi M6.

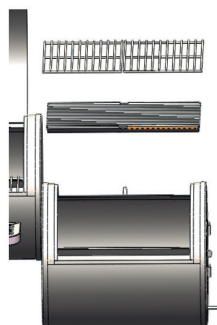

20. Inserire la vaschetta a carbone e la griglia nella camera di affumicazione laterale.

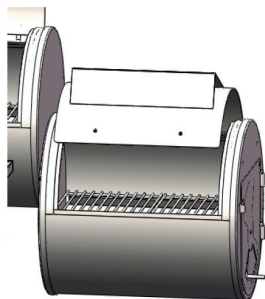

21. Assemblare il coperchio della camera di affumicazione laterale.

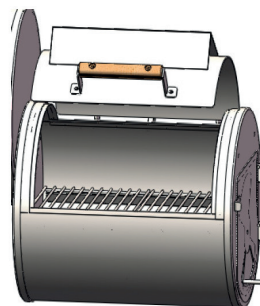

22. Assemblare l'impugnatura utilizzando le viti M6*15 e i dadi M6.

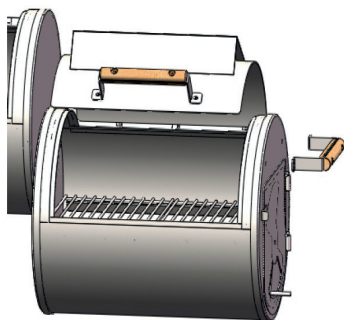

23. Assemblare l'impugnatura laterale utilizzando le viti M6*15 e i dadi M6.



24. Fissare il recipiente dell'olio e il gancio.

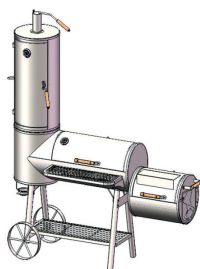

25. Infine fissare il termometro.

Produttore: Chal-Tec GmbH, Wallstraße 16, 10179 Berlino, Germania