

WINDOW KIT 2 | 3

Fensterabdichtung
Window Seal
Calfeutrage fenêtre
Guarnizione per finestra
Cubierta de ventana

10030315 10030316



COMFORTING
OMFORTING
FORTINGCO
TINGCOMFO
COMFORTING
OMFORTING
FORTINGCO
TINGCOMFO

KLARSTEIN

www.klarstein.com

Sehr geehrter Kunde,

wir gratulieren Ihnen zum Erwerb Ihres Gerätes. Lesen Sie die folgenden Hinweise sorgfältig durch und befolgen Sie diese, um möglichen Schäden vorzubeugen. Für Schäden, die durch Missachtung der Hinweise und unsachgemäßen Gebrauch entstehen, übernehmen wir keine Haftung. Scannen Sie den folgenden QR-Code, um Zugriff auf die aktuellste Bedienungsanleitung und weitere Informationen rund um das Produkt zu erhalten:

**Dear Customer,**

Congratulations on purchasing this device. Please read the following instructions carefully and follow them to prevent possible damages. We assume no liability for damage caused by disregard of the instructions and improper use. Scan the QR code to get access to the latest user manual and more product information.

**Estimado cliente,**

Le felicitamos por la adquisición de este producto. Lea atentamente las siguientes instrucciones y sígalas para evitar posibles daños. No asumimos ninguna responsabilidad por los daños causados por el incumplimiento de las instrucciones y el uso inadecuado. Escanee el siguiente código QR para obtener acceso a la última guía del usuario y más información sobre el producto.

**Chère cliente, cher client,**

Toutes nos félicitations pour l'acquisition de ce nouvel appareil. Veuillez lire attentivement et respecter les instructions de ce mode d'emploi afin d'éviter d'éventuels dommages. Nous ne saurions être tenus pour responsables des dommages dus au non-respect des consignes et à la mauvaise utilisation de l'appareil. Scannez le QR-Code pour obtenir la dernière version du mode d'emploi et des informations supplémentaires concernant le produit.

**Gentile cliente,**

La ringraziamo per aver acquistato il dispositivo. La preghiamo di leggere attentamente le seguenti istruzioni per l'uso e di seguirle per evitare possibili danni. Non ci assumiamo alcuna responsabilità per danni scaturiti da una mancata osservazione delle avvertenze di sicurezza e da un uso improprio del dispositivo. Scansionare il codice QR seguente, per accedere al manuale d'uso più attuale e per ricevere informazioni sul prodotto.



BEFESTIGUNG DER FENSTERDICHTUNG

Befestigung des Dichtungsrahmens für Schiebefenster

Der Dichtungsrahmen für Schiebefenster wurde so konzipiert, dass er in die meisten vertikalen und horizontalen Standard-Fenster passt. Es kann jedoch erforderlich sein, dass Sie einige Aspekte der Installation für bestimmte Fenstertypen ändern müssen. Der Dichtungsrahmen kann mit Schrauben befestigt werden.

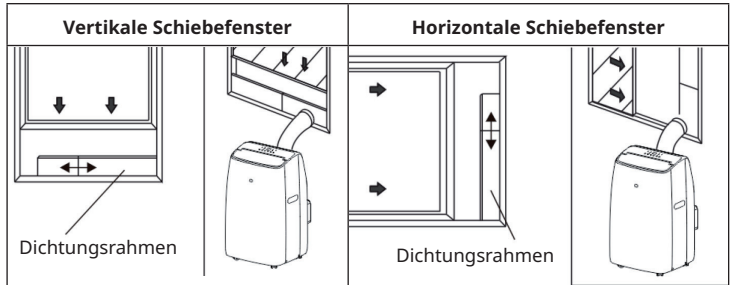

 <p>● Fall nötig, auf dieser Seite abschneiden.</p>	<p>Hinweis: Wenn die Fensteröffnung kleiner ist als die Mindestlänge des Dichtungsrahmens, schneiden Sie das Ende auf der anderen Seite des Luftauslasses kurz genug ab, damit der Dichtungsrahmen in die Fensteröffnung passt. Schneiden Sie niemals das Loch ab.</p>
--	---

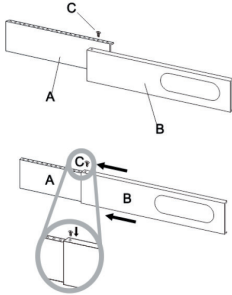

Anpassung des Dichtungsrahmens für Schiebefenster

<p>Schieben Sie Rahmen (B) in Rahmen (A) und passen Sie die Größe des Rahmens an die Breite Ihres Fensters an. Arretieren Sie die Feststellschraube (C) in den Löchern, die der gemessenen Breite entsprechen, um sicherzustellen, dass nach dem Einbau keine Lücken oder Lufteinschlüsse zwischen Fenster und Dichtungsrahmen vorhanden sind.</p>	
--	---

Befestigung der Dichtung für seitlich zu öffnende Fenster und Dachfenster

Die Montage der Fensterdichtung ist einfach. Sie können die Dichtung an ein gekipptes Fenster, ein seitlich geöffnetes Fenster oder ein Dachfenster anbringen. Wir haben hier zur Demonstration ein seitlich geöffnetes Fenster gewählt. Es eignet sich besonders gut, weil sich der Abluftschlauch seitlich weit nach unten anbringen lässt.

Das Klettband wird an den drei offenen Seiten angebracht. Die Seite, an der das Fenster am Rahmen anliegt, wird ausgelassen. Den Fensterrahmen vorher reinigen und trocknen, damit das Band haftet.

1	2	3
		
<p>Kleben Sie das Klettband links, oben und unten am Fensterrahmen an.</p> <p>Am besten schneiden Sie für jede Seite einen Streifen zu.</p>	<p>Kleben Sie das Klettband nun auch an die Innenseite des Fensters.</p>	<p>Kletten Sie die Fensterdichtung an das Klettband im Fensterrahmen (oben beginnen) und anschließend an das Klettband im Fenster.</p> <p>Führen Sie den Abluftschlauch des Klimagerätes durch das Loch, welches Sie durch die Reißverschlüsse in der Höhe und Größe anpassen können.</p>

FIXING THE WINDOW SEAL

Fixing the sealing frame for sliding windows

The sliding window sealing frame is designed to fit most standard vertical and horizontal windows. However, you may need to change some aspects of the installation for certain types of windows. The sealing frame can be fixed with screws.

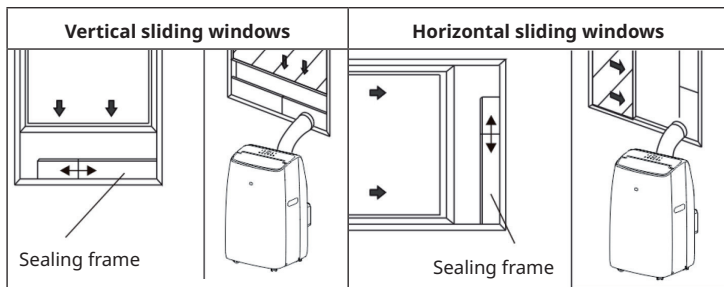

<p>● If necessary, trim on this side.</p>	<p>Note: If the window opening is smaller than the minimum length of the gasket frame, cut the end on the other side of the air outlet short enough for the gasket frame to fit into the window opening. Never cut the hole.</p>
---	---



Adjusting the sealing frame for sliding windows

<p>Slide frame (B) into frame (A) and adjust the size of the frame to the width of your window. Lock the locking screw (C) in the holes corresponding to the measured width to ensure that there are no gaps or air pockets between the window and sealing frame after installation.</p>	<p>The diagram shows two parts of the sealing frame, labeled A and B, being joined together. A locking screw, labeled C, is used to secure the joint. Below this, a circular tool is shown adjusting the frame, with arrows indicating the direction of movement and a label 'C' pointing to the locking screw.</p>
--	---

Fixing the seal for side-opening windows and roof windows

The installation of the window seal is simple. You can attach the seal to a tilted window, a side-opened window or a roof window. We have chosen a side-opened window for demonstration purposes. It is particularly suitable because the exhaust hose can be attached to the side far down.

The Velcro tape is attached to the three open sides. The side where the window is against the frame is left out. Clean and dry the window frame beforehand so that the tape adheres.

1	2	3
		
<p>Attach the Velcro tape on the left, on the top and on the bottom of the window frame.</p> <p>We recommend that you cut the tape into strips for each window side first.</p>	<p>Now attach the Velcro tape to the inner window sides.</p>	<p>Stick the window sealing to the Velcro strips on the window frame first (starting with the top), then on the Velcro strips on the window.</p> <p>Push the exhaust air tube of the air conditioner through the hole, which can be adjusted in height and size.</p>

FIJACIÓN DE LA JUNTA DE LA VENTANA

Fijación para ventanas correderas

La junta de sellado de la ventana corredera ha sido diseñado para adaptarse a la mayoría de las ventanas verticales y horizontales estándar. Sin embargo, es posible que tenga que modificar algunos aspectos de la instalación para determinados tipos de ventanas. El marco de sellado se puede fijar con tornillos.

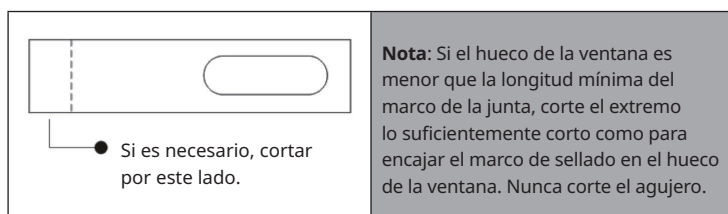
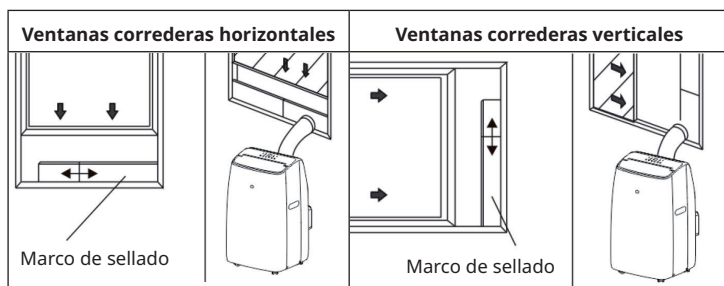

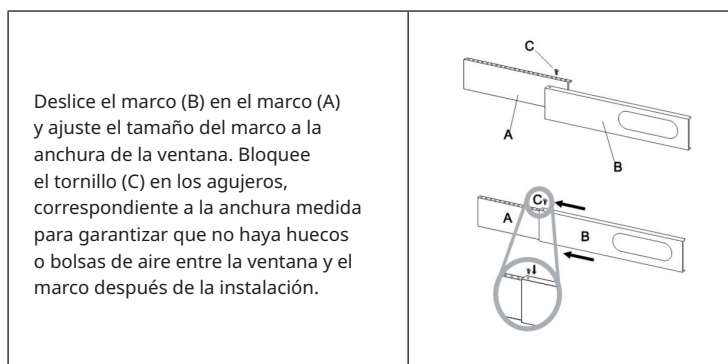

Ajuste del marco para ventanas correderas



Fijación de la junta para ventanas de apertura lateral o de techo

El montaje de la junta para ventana es sencillo. Puede montarla en una ventana de corredera o en una ventana abatible o una ventana de techo. Para la demostración, hemos seleccionado una ventana de corredera. Es especialmente apropiada para instalar el conducto de evacuación en una posición inferior.

El velcro se monta en tres de los lados abiertos. Se deja libre el lado que da al marco de la ventana. Limpiar y secar previamente el marco de la ventana para que el velcro se adhiera.

1	2	3
		
<p>Pegue el velcro a la izquierda, en la parte superior e inferior del marco de la ventana.</p> <p>Se recomienda cortar el velcro en tiras para cada lado.</p>	<p>Pegue el velcro también en el lado interior de la ventana.</p>	<p>Pegue la junta para la ventana en el velcro del marco de la ventana (comenzar por arriba) y finalmente al velcro de la ventana.</p> <p>Introduzca el conducto de evacuación del climatizador en el orificio, cuyo ancho y alto puede ajustar con el cierre de cremallera.</p>

INSTALLATION DU JOINT DE FENÊTRE

Fixation du cadre d'étanchéité pour les fenêtres coulissantes

Le cadre d'étanchéité de fenêtre coulissante est conçu pour s'adapter à la plupart des fenêtres verticales et horizontales standard. Cependant, vous devrez peut-être modifier certains aspects de l'installation pour certains types de fenêtres. Le cadre d'étanchéité peut se fixer avec des vis.

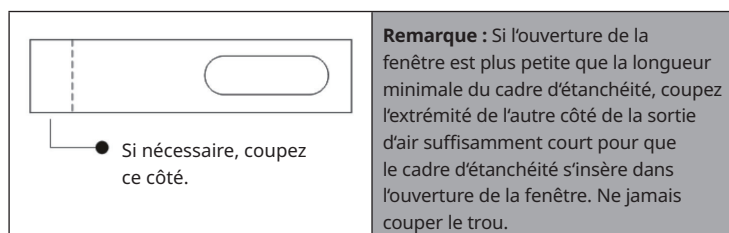
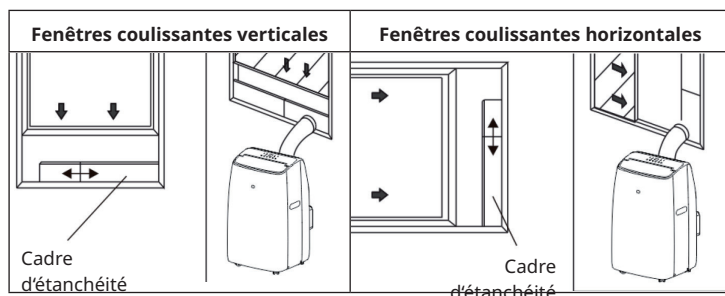

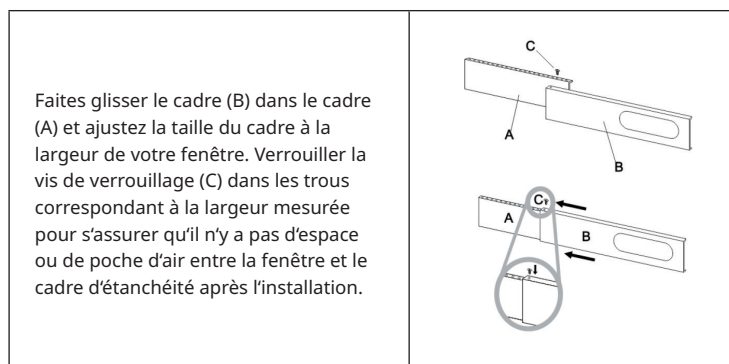

Ajustement du cadre d'étanchéité pour fenêtre coulissante



Fixation du joint pour fenêtres à ouverture latérale et puits de lumière

L'installation du joint de fenêtre est simple. Vous pouvez fixer le joint à une fenêtre inclinée, à une fenêtre coulissante ou à une lucarne. Nous avons choisi une fenêtre coulissante à des fins de démonstration. Ce type de fenêtre convient spécialement car le tuyau d'échappement peut être fixé latéralement très bas.

La bande adhésive se fixe aux trois côtés ouverts. Le côté de la fenêtre qui repose contre le cadre est omis. Nettoyez et séchez d'abord le cadre de la fenêtre pour permettre à la bande d'adhérer.

1	2	3
		
<p>Collez la bande adhésive à gauche, en haut et en bas du cadre de la fenêtre.</p> <p>Il est préférable de couper une bande pour chaque côté.</p>	<p>Collez maintenant la bande adhésive à l'intérieur de la fenêtre également.</p>	<p>Fixez le joint de fenêtre à la bande adhésive dans le cadre de la fenêtre (commencez en haut), puis à la bande adhésive dans la fenêtre.</p> <p>Faites passer le tuyau d'air venant du climatiseur par le trou que vous pouvez régler en hauteur et en taille à l'aide des fermetures à glissière.</p>

INSTALLARE LA GUARNIZIONE

Fissaggio del telaio di guarnizione per finestre scorrevoli

Il telaio di guarnizione per finestre scorrevoli è stato concepito in modo da essere adatto alla maggior parte di finestre standard orizzontali e verticali. Tuttavia, può essere necessario modificare alcuni aspetti dell'installazione per determinati tipi di finestre. Il telaio di guarnizione può essere fissato con viti.

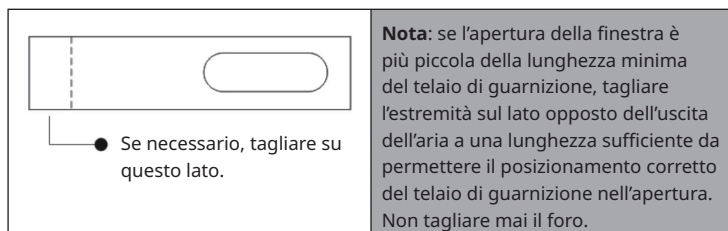
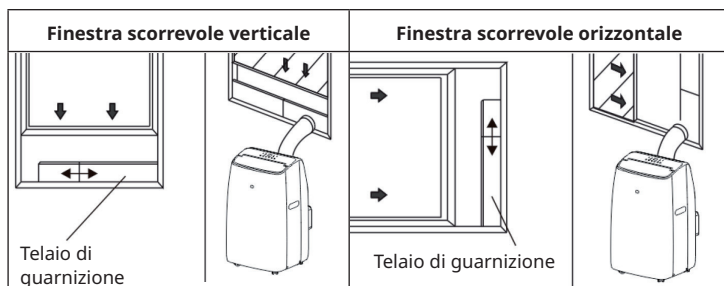

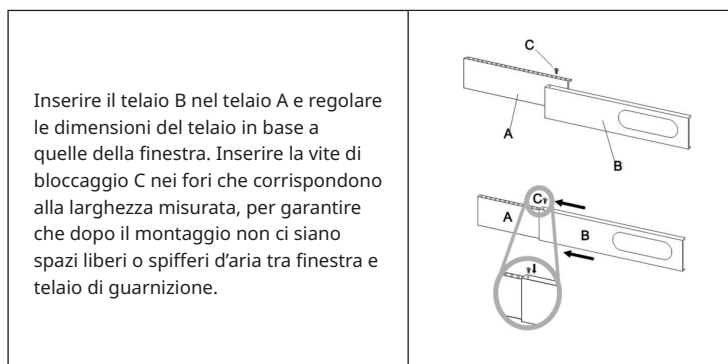

Regolare il telaio di guarnizione per finestre scorrevoli



Fissaggio della guarnizione per finestre ad apertura laterale o da soffitto

Installare la guarnizione per la finestra è semplice. E' possibile installare la guarnizione ad una finestra, ad apertura inclinata, ad una finestra ad apertura laterale oppure ad un lucernario. La dimostrazione in basso è eseguita con una finestra ad apertura laterale. Questo tipo di finestra è particolarmente adatto poiché si può installare il tubo di scarico in basso.

Il nastro di velcro adesivo deve essere installato su tre lati. Lasciare libero il lato nel quale la finestra è connessa al telaio. Il telaio della finestra deve essere prima pulito ed asciugato affinché il nastro possa incollarsi.

1	2	3
		
<p>Incollare il nastro di velcro adesivo a sinistra, a destra e nella parte superiore del telaio della finestra.</p> <p>Si consiglia di tagliare a strisce il nastro di velcro adesivo per ogni lato della finestra.</p>	<p>Incollare il nastro di velcro adesivo anche nella parte interna della finestra.</p>	<p>Fissare la guarnizione alle strisce in velcro poste sul telaio (iniziare in alto al centro) e poi alle strisce in velcro poste sulla finestra.</p> <p>Inserire il tubo di scarico del climatizzatore nell'apertura, la quale è regolabile in altezza e in grandezza attraverso la cerniera.</p>

HERSTELLER

Manufacturer | Fabricante | Fabricant | Produttore

Chal-Tec GmbH, Wallstraße 16, 10179 Berlin, Deutschland (Germany).

IMPORTEUR FÜR GROSSBRITANNIEN

Importer for Great Britain | Importador para Gran Bretaña | Importateur pour la Grande Bretagne | Importatore per la Gran Bretagna

Chal-Tec UK limited
Unit 6 Riverside Business Centre
Brighton Road
Shoreham-by-Sea
BN43 6RE
United Kingdom



KLARSTEIN