

Benchex

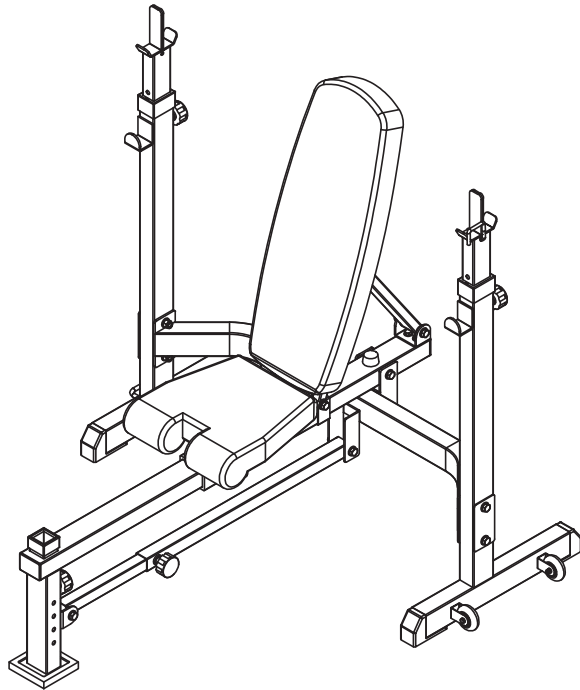

Sehr geehrter Kunde,

zunächst möchten wir Ihnen zum Erwerb Ihres Geräts gratulieren. Bitte lesen Sie die folgenden Anschluss- und Anwendungshinweise sorgfältig durch und befolgen Sie diese um möglichen technischen Schäden vorzubeugen.

Artikel

Artikelnummer: 10032050

Sicherheitshinweise

- Bewahren Sie die Verpackung und die Bedienungsanleitung nach der Montage auf.
- Überprüfen Sie die Schrauben in regelmäßigen Abständen.
- Stellen Sie das Trainingsgerät an einem geräumigen Ort auf.
- Stellen das Gerät auf ebenem Untergrund auf. Verwenden Sie eine Matte, um das Gerät zu schützen.
- Konsultieren Sie vor der Verwendung von Trainingsgeräten einen Arzt.
- Auf der Mutter befindet sich eine rutschfeste Scheibe. Bitte mit einem Schraubenschlüssel festziehen.
- Das Trainingsgerät ist ausschließlich für den Hausgebrauch vorgesehen und nicht für geschäftliche Zwecke.
- Ziehen Sie die Schrauben fest. Die Benutzung des Trainingsgeräts kann sonst gefährlich sein.
- Verändern Sie das Gerät nicht auf irgendeine Weise. Es gefährlich ist das Gerät zu verändern oder auszubessern.
- Bewahren Sie das Gerät an einem Ort fern von Feuchtigkeit oder Salz, hohen Temperaturen oder Sonneneinstrahlung auf.
- Wartung und Reinigung: Entfernen Sie Schmutz mit einem Reinigungsmittel. Verwenden Sie einen trockenen Lappen und sauberes Wasser. Verwenden Sie weder Gas, Lösungsmittel noch andere Chemikalien.
- Stecken Sie Ihre Hand während der Übungen nicht in bewegliche Teile des Trainingsgeräts.

Teile des Geräts

Überprüfen Sie den Lieferumfang auf Vollständigkeit hin.

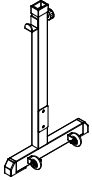

(1) Stütze links

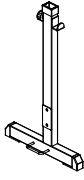

(2) Stütze rechts

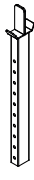

(3) Verstellbare
Hantelstütze

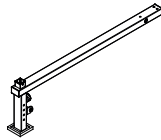

(4) Hauptgestell

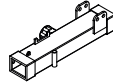

(5) Schlitten

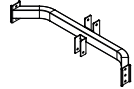

(6) Stützstrebe

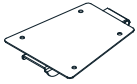

(7) Sitzpolsterblech

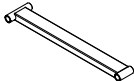

(8) Stützstrebe



(9) Rückenstütze



(10) Linker Stift

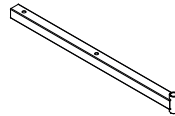

(11) ADJUSTMENT CHROME
TUBE

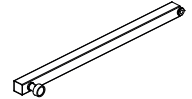

(12) Verstellbares
Rohrgehäuse



(13) Sitzpolster

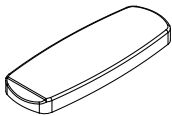

(14) Rückenlehne



(15) Montagebügel



(16) Feder



(17) Handschraube



(18) Sicherheitshaken
für linke Scheibe



(19) Sicherheitshaken
für rechte Scheibe



(20) Gummipuffer



(21) 25 runder
Endstößel

Schrauben

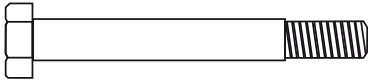

(22) M12 X 180 Sechkantschraube 1 Stck

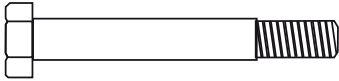

(23) M12 X 170 Sechkantschraube 1 Stck

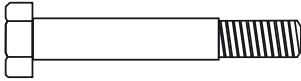

(24) M12 X 110 Sechkantschraube 2 Stck

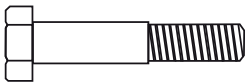

(25) M12 X 90 Sechkantschraube 2 Stck



(26) M12 X 75 Sechkantschraube 5 Stck



(27) M8 X 40 Sechkantschraube 4 Stck

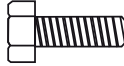

(29) M8 X 20 Sechkantschraube 4 Stck



(31) M8 Kontermutter 2 Stck



(33) M10 Unterlegscheiben 2 Stck

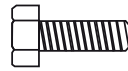

(28) M10 X 20 Sechkantschraube
2 Stck

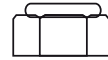

(30) M12 Kontermutter 12 Stck



(32) M12 Unterlegscheiben 23 Stck



(34) M8 Unterlegscheiben 8 Stck

Dear Customer,

Congratulations on purchasing this equipment. Please read this manual carefully and take care of the following hints on installation and use to avoid technical damages. Any failure caused by ignoring the items and cautions mentioned in the operation and installation instructions are not covered by our warranty and any liability.

Item

Item number: 10032050

Safety Instructions

- Please keep the box and the manual after installing the machine.
- Check the stability of the bolts regularly.
- Please install the machine in a commodious place.
- Put the machine on the level ground, and use a mat to protect the floor.
- Please consult to your doctor, physician before using any exercise equipment.
- There are slip proof cover on the nut (little nylon circle on the nut); please tighten them with wrench.
- The product is only for Domestic use not for Commercial purposes.
- Please tighten the screws; otherwise it might be dangerous to use.
- Please do not alter the machine in any way it might be dangerous to change and mend the machine.
- Store in the place where is away from moisture, salt (near Pool) high temperature and under sun.
- For maintenance and cleaning exercise machines Please clean the dirt with detergent scour, using dry rag and clean water (do not use gas, dilution and other chemicals).
- Do not put your hands in the moving part of the machine when you are doing exercise.

Parts List

Inspect carefully that all parts are included.

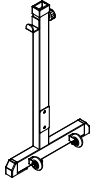

(1) LEFT UPRIGHT FRAME

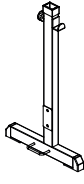

(2) RIGHT UPRIGHT FRAME



(3) BARBELL ADJUSTABLE FRAME

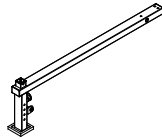

(4) MAIN FRAME

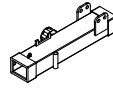

(5) CARRIAGE

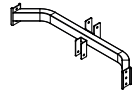

(6) BACK UP BEAM

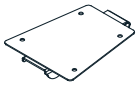

(7) SEAT CUSHION FRAME

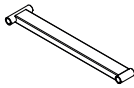

(8) SUPPORT BAR

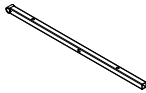

(9) BACK SUPPORT FRAME



(10) L PIN

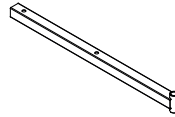

(11) ADJUSTMENT CHROME TUBE

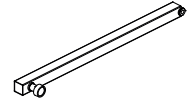

(12) ADJUSTABLE TUBE HOUSING



(13) SEAT CUSHION

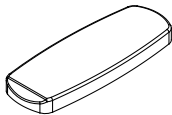

(14) BACKREST CUSHION



(15) U BRACKET



(16) SPRING



(17) LOCK KNOB



SAFETY HOOK



(19) RIGHT BARBELL SAFETY HOOK



(20) RUBBER BUMPER



(21) 25 ROUND END PLUG

Screws

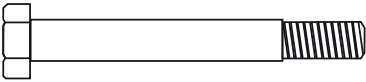

(22) M12 X 180 HEX BOLT 1PC

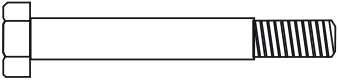

(23) M12 X 170 HEX BOLT 1PC

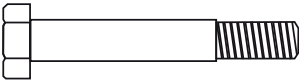

(24) M12 X 110 HEX BOLT 2PCS

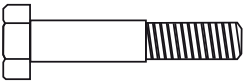

(25) M12 X 90 HEX BOLT 2PCS



(26) M12 X 75 HEX BOLT 5PCS



(27) M8 X 40 HEX BOLT 4PCS

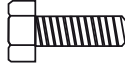

(29) M8 X 20 HEX BOLT 4PCS



(31) M8 LOCK NUT 2PC



(33) M10 WASHER 2PCS

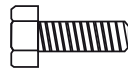

(28) M10 X 20 HEX BOLT 2PCS

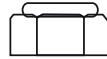

(30) M12 LOCK NUT 12PCS



(32) M12 WASHER 23PCS



(34) M8 WASHER 10PCS

Montage / Assembly

1

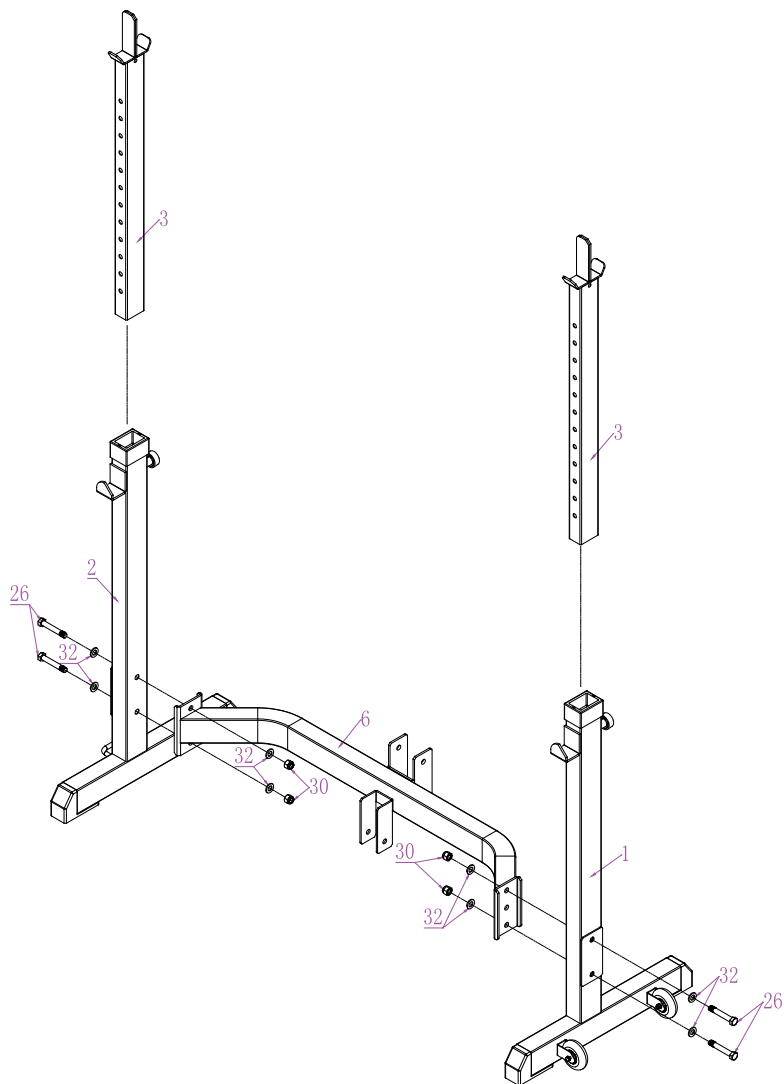

2

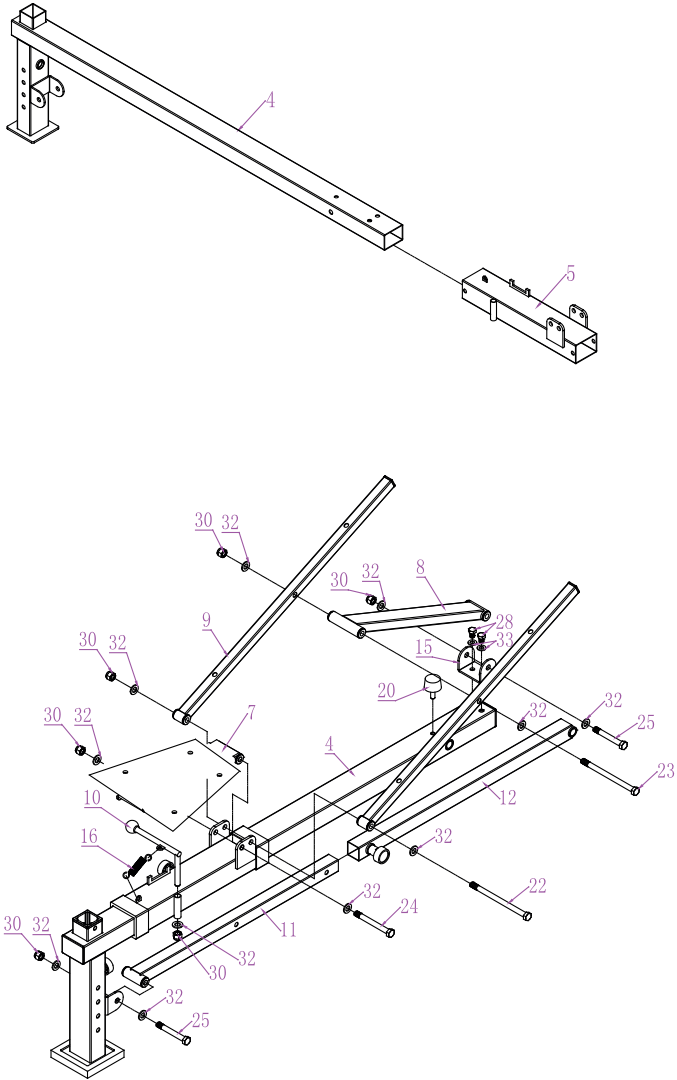

3

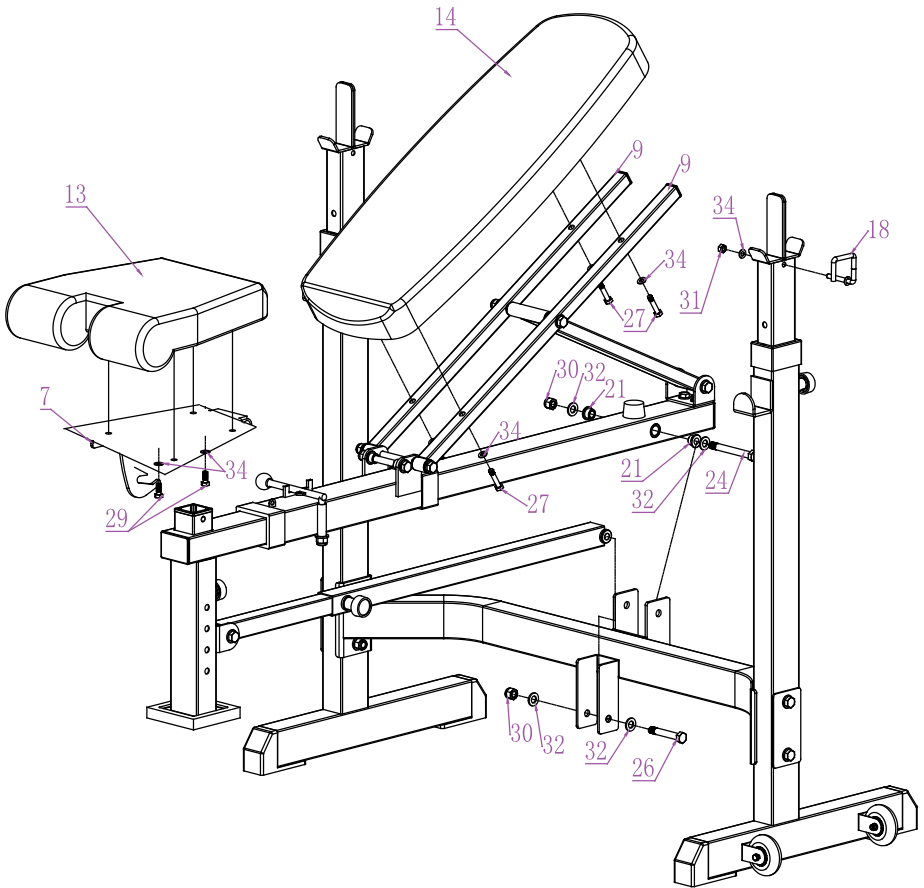

Hersteller: Chal-Tec GmbH, Wallstraße 16, 10179 Berlin. Deutschland

Producer: Chal-Tec GmbH, Wallstraße 16, 10179 Berlin. Germany