

BROOKLYN-BBQ

Grillfass
Barbecue Barrel
Barril de barbacoa
Tonneau barbecue
Barbecue barile

10032510



COOKINGCO
OOKINGCOO
KINGCOOKIN
INGCOOKING
COOKINGCO
OOKINGCOO
KINGCOOKIN
INGCOOKING

KLARSTEIN

www.klarstein.com

Sehr geehrter Kunde,

wir gratulieren Ihnen zum Erwerb Ihres Gerätes. Lesen Sie die folgenden Hinweise sorgfältig durch und befolgen Sie diese, um möglichen Schäden vorzubeugen. Für Schäden, die durch Missachtung der Hinweise und unsachgemäßen Gebrauch entstehen, übernehmen wir keine Haftung. Scannen Sie den folgenden QR-Code, um Zugriff auf die aktuellste Bedienungsanleitung und weitere Informationen rund um das Produkt zu erhalten:

**Dear Customer,**

Congratulations on purchasing this device. Please read the following instructions carefully and follow them to prevent possible damages. We assume no liability for damage caused by disregard of the instructions and improper use. Scan the QR code to get access to the latest user manual and more product information.

**Estimado cliente,**

Le felicitamos por la adquisición de este producto. Lea atentamente las siguientes instrucciones y síguelas para evitar posibles daños. No asumimos ninguna responsabilidad por los daños causados por el incumplimiento de las instrucciones y el uso inadecuado. Escanee el siguiente código QR para obtener acceso a la última guía del usuario y más información sobre el producto.

**Chère cliente, cher client,**

Toutes nos félicitations pour l'acquisition de ce nouvel appareil. Veuillez lire attentivement et respecter les instructions de ce mode d'emploi afin d'éviter d'éventuels dommages. Nous ne saurions être tenus pour responsables des dommages dus au non-respect des consignes et à la mauvaise utilisation de l'appareil. Scannez le QR-Code pour obtenir la dernière version du mode d'emploi et des informations supplémentaires concernant le produit.

**Gentile cliente,**



















La ringraziamo per aver acquistato il dispositivo. La preghiamo di leggere attentamente le seguenti istruzioni per l'uso e di seguirle per evitare possibili danni. Non ci assumiamo alcuna responsabilità per danni scaturiti da una mancata osservazione delle avvertenze di sicurezza e da un uso improprio del dispositivo. Scansionare il codice QR seguente, per accedere al manuale d'uso più attuale e per ricevere informazioni sul prodotto.











DE	<ul style="list-style-type: none"> • Dieses Produkt ist nur für Holzkohle geeignet! Befüllen Sie die Feuerschale (Teilenummer 17) zu maximal 75% mit Holzkohle. • Die Beschichtung hält Temperaturen bis maximal 300 °C aus. • Hinweis: Übermäßiges Verbrennen von Holzscheiten, Holz, Abfällen und/oder anderen Materialien kann zu einer Außentemperatur von über 300 °C führen, was zum Abplatzen der Außenbeschichtung führt. Die Verwendung des Produkts außerhalb des vorgesehenen Anwendungsbereichs (BBQ) kann zu Qualitäts- und Sicherheitsproblemen führen.
EN	<ul style="list-style-type: none"> • This product is only suitable for charcoal! Fill the fire bowl (part number 17) to a maximum of 75% with charcoal. • The coating can withstand temperatures up to a maximum of 300 °C. • Note: Excessive burning of logs, wood, waste and/or other materials may result in an external temperature exceeding 300 °C, which will cause the external coating to flake off. Use of the product outside of the intended application (BBQ) may result in quality and safety issues.
ES	<ul style="list-style-type: none"> • Este producto sólo es adecuado para el carbón vegetal. Llene el recipiente para el fuego (número de pieza 17) hasta un máximo del 75% con carbón vegetal. • El revestimiento puede soportar temperaturas de hasta un máximo de 300 °C. • Nota: La quema excesiva de troncos, madera, residuos y/u otros materiales puede provocar una temperatura exterior superior a 300 °C, lo que hará que el revestimiento exterior se desprenda. El uso del producto fuera del área de aplicación prevista (barbacoa) puede provocar problemas de calidad y seguridad.
FR	<ul style="list-style-type: none"> • Ce produit ne peut être utilisé qu'avec du charbon de bois ! Remplissez le bac à feu (pièce n° 17) à 75% maximum avec du charbon de bois. • Le revêtement résiste à des températures de 300 °C maximum. • Remarque : une combustion excessive de bûches, de bois, de déchets et/ou d'autres matériaux peut entraîner une température extérieure supérieure à 300 °C et provoquer l'éclatement du revêtement extérieur. L'utilisation du produit en dehors du domaine d'application prévu (BBQ) peut entraîner des problèmes de qualité et de sécurité.
IT	<ul style="list-style-type: none"> • Questo prodotto è adatto solo per il carbone! Riempi il contenitore del fuoco (numero di parte 17) fino a un massimo del 75% con carbone. • Il rivestimento può resistere a temperature fino a un massimo di 300 °C. • Nota: una combustione eccessiva di tronchi, legna, rifiuti e/o altri materiali può portare a una temperatura esterna superiore a 300 °C, con conseguente distacco del rivestimento esterno. L'uso del prodotto al di fuori dell'area di applicazione prevista (BBQ) può causare problemi di qualità e sicurezza.

LIEFERUMFANG

Scope of delivery | Volumen de suministro | Contenu de la livraison |
Dotazione di fornitura

1		X1
2		X1
3		X1
4		X1
5		X1
6		X6
7		X1
8		X2
9		X3
10		X1
11		X2
12		X3
13		X1
14		X1
15		X2
16		X1
17		X1
18		X3
19		X1

A	M5x12		X8
B	ϕ 6X16		X10
C	M5		X8
D	M6x70		X2
E	M6		X5
F	M6x12		X4
G	M6x20		X3
H	M6x16		X1

ZUSAMMENBAU

Assembly | Ensamblaje | Assemblée | Assemblaggio

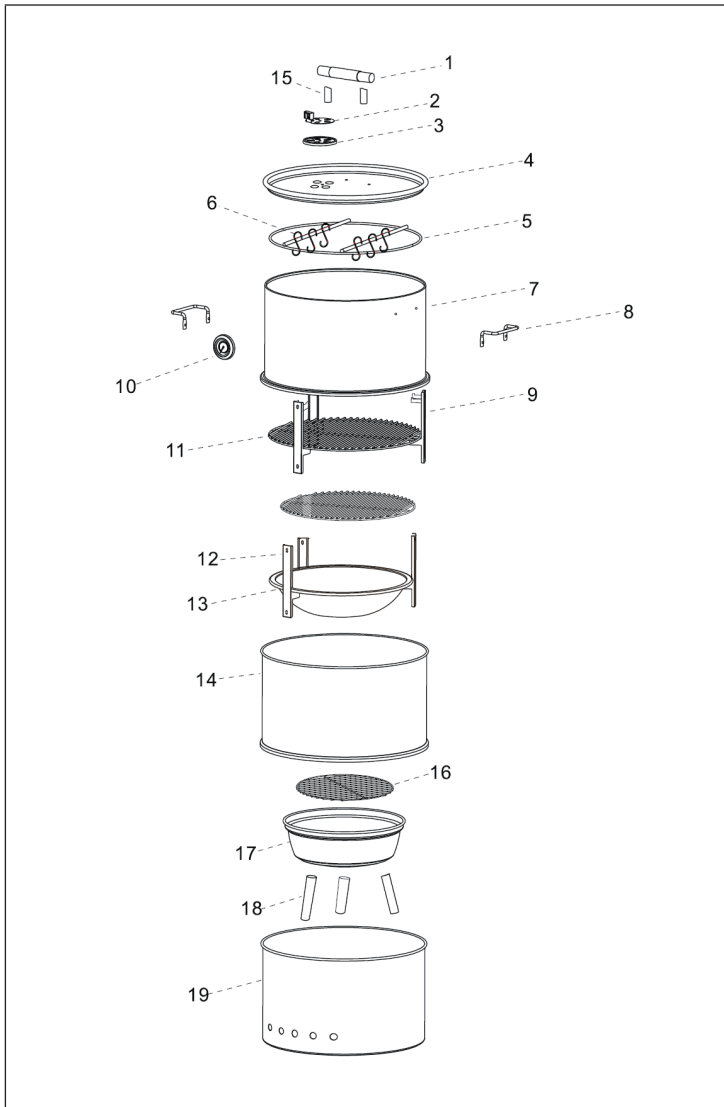

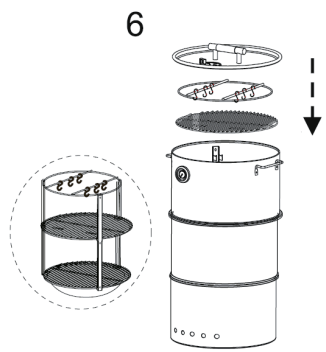
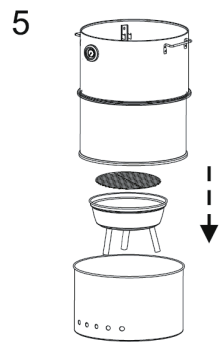
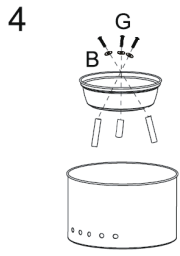
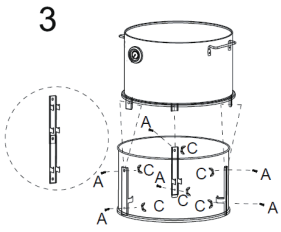
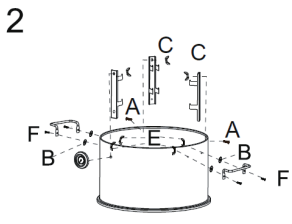
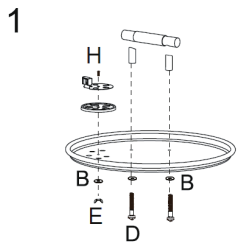

HERSTELLER

Manufacturer | Fabricante | Fabricant | Produttore

Chal-Tec GmbH, Wallstraße 16, 10179 Berlin, Deutschland (Germany).

IMPORTEUR FÜR GROSSBRITANNIEN

Importer for Great Britain | Importador para Gran Bretaña | Importateur pour la Grande Bretagne | Importatore per la Gran Bretagna

Berlin Brands Group UK Limited
PO Box 42
272 Kensington High Street
London, W8 6ND
United Kingdom



KLARSTEIN