



blumfeldt



Titus

Gartentermin

Garden Fireplace

Cheminée de jardin

Chimenea de jardín

Camino da giardino

10032985

Sehr geehrter Kunde,

wir gratulieren Ihnen zum Erwerb Ihres Gerätes. Lesen Sie die folgenden Hinweise sorgfältig durch und befolgen Sie diese, um möglichen Schäden vorzubeugen. Für Schäden, die durch Missachtung der Hinweise und unsachgemäßen Gebrauch entstehen, übernehmen wir keine Haftung. Scannen Sie den folgenden QR-Code, um Zugriff auf die aktuellste Bedienungsanleitung und weitere Informationen rund um das Produkt zu erhalten:



INHALTSVERZEICHNIS

Sicherheitshinweise 4
Geräteübersicht 5
Kleinteile 6
Zusammenbau 6
Reinigung und Pflege 10

English 13
Français 23
Español 33
Italiano 43

HERSTELLER & IMPORTEUR (UK)

Hersteller:

Chal-Tec GmbH, Wallstraße 16, 10179 Berlin, Deutschland.

Importeur für Großbritannien:

Chal-Tec UK limited
Unit 6 Riverside Business Centre
Brighton Road
Shoreham-by-Sea
BN43 6RE
United Kingdom

SICHERHEITSHINWEISE



WARNUNG

Erstickungsgefahr! Der Gartenkamin ist nur zur Nutzung im Freien bestimmt. Er darf nicht in Gebäuden, Garagen oder anderen geschlossenen Bereichen verwendet werden. Es können sich giftige Dämpfe bilden, die zum Ersticken führen.



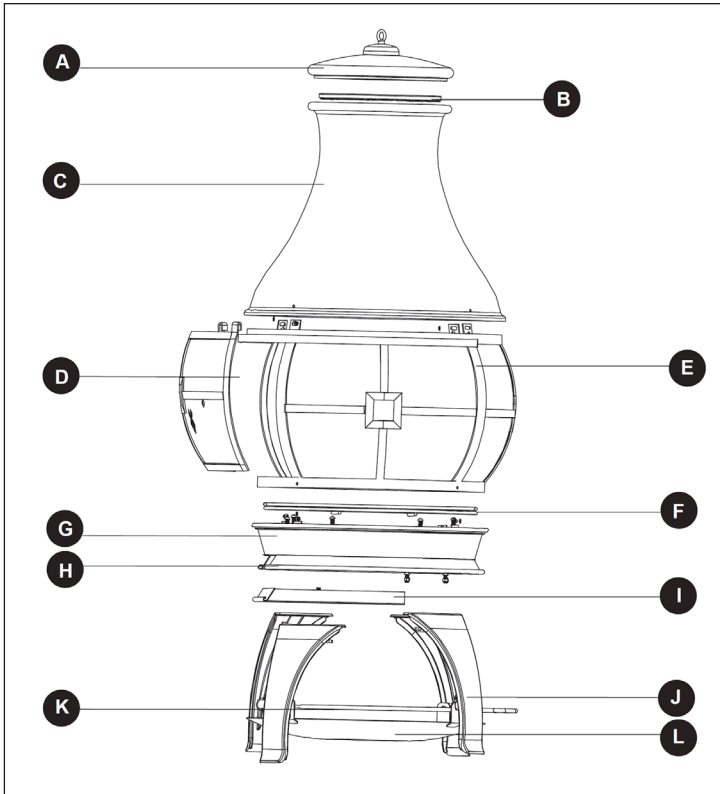

- Die Feuerstelle ist nicht für gewerbliche Zwecke geeignet.
- Die Feuerstelle darf nur von Erwachsenen verwendet werden. Kinder und Haustiere müssen einen sicheren Abstand einhalten.
- Verwenden Sie zum Anzünden kein Benzin, Brennspritus, Feuerzeugbenzin oder Alkohol.
- Benutzen Sie die Feuerstelle nicht, bevor sie nicht vollständig zusammengebaut wurde und alle Teile fest sitzen.
- Verwenden Sie die Feuerstelle nicht auf Untergründen aus Holz oder anderen brennbaren Materialien.
- Leeren Sie die Feuerstelle nach jeder Verwendung. Lassen Sie eine dünne Ascheschicht darin, um den Boden zu schützen. Nehmen Sie die Asche erst heraus, wenn die Kohle komplett abgebrannt und die Asche abgekühlt ist.
- Fassen Sie den Kamin erst an, wenn er komplett abgekühlt ist; Tragen Sie während dem Betrieb hitzebeständige Handschuhe.
- Verstauen Sie den Kamin erst wenn er komplett abgekühlt ist und die Asche entsorgt wurde.
- Verwenden Sie immer Werkzeuge und hitzebeständige Handschuhe, wenn Sie Brennmaterial hinzufügen oder den Kamin bewegen.
- Lassen Sie den Kamin während der Benutzung nicht unbeaufsichtigt.
- Während der Benutzung kann heiße Glut aus dem Kamin fallen.
- Überladen Sie den Kamin nicht mit Brennmaterial. Fügen Sie erst dann neues Brennmaterial hinzu, wenn das Feuer heruntergebrannt ist. Wenn ein Teil der Feuerschale rot glüht, ist sie überladen.
- Legen Sie das Brennmaterial nicht direkt auf den Boden des Kamins.
- Halten Sie den Brennstoff von Wand der Feuerstelle fern, da die Wand von hohen Temperaturen beschädigt werden kann.
- Atmen Sie den Rauch nicht ein und lassen Sie ihn nicht in die Ihre Augen kommen.
- Untersuchen Sie die Feuerstelle vor der Benutzung auf Beschädigungen.
- Durch die Benutzung kann sich die Metalloberfläche leicht verfärben.

GERÄTEÜBERSICHT

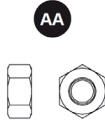
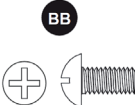
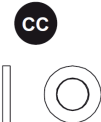

A	Schornsteinkappe (1x)	G	Obere Ofenschale (1x)
B	Netzabdeckung (1x)	H	Untere Ofenschale (1x)
C	Schornstein (1x)	I	Aschebehälter (1x)
D	Schiebetür (1x)	J	Bein (4x)
E	Abschirmung (1x)	K	Schürhaken (1x)
F	Kohlengitter (2x)	L	Feuerholz-Regal (1x)

KLEINTEILE

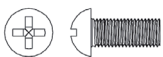
			
<p>Mutter (16x)</p>	<p>M6*12 mm Schraube (4x)</p>	<p>Unterlegscheibe (20x)</p>	<p>Federscheibe (16x)</p>
			
<p>Flache Schraube M6*15 mm (4x)</p>	<p>Flache Schraube M6*20 mm (4x)</p>	<p>Schraube M6*15 mm (8x)</p>	

ZUSAMMENBAU





Vor dem Zusammenbau

Vergewissern Sie sich vor der Montage, dass alle Teile vorhanden sind. Vergleichen Sie die Teile mit der Teile. Wenn ein Teil fehlt oder beschädigt ist, versuchen Sie nicht, das Produkt zusammenzubauen. Wenden Sie sich an den Kundendienst.

Hinweis: Für den Zusammenbau benötigen Sie einen Kreuzschlitzschraubenzieher und einen 3/8" Schraubenschlüssel. Nehmen Sie sich für den Zusammenbau eine zweite Person zu Hilfe.

Zusammenbau

1
Richten Sie die obere Ofenschale (G) an der unteren Ofenschale (H) aus. Befestigen Sie die Beine (J) mit Schrauben M6 x 15 (GG), Muttern (AA), Unterlegscheiben (CC) und Federscheiben (DD) an den Ofenschalen.

AA Mutter		x 8
CC Unterlegscheibe		x 8
DD Federscheibe		x 8
GG Schraube M6*15		x 8

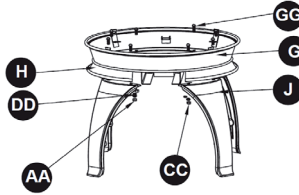

2
Setzen Sie die Feuerholz-Regal (L) in die Mitte des Gerätes und befestigen Sie es mit Schrauben M6 x 12 (BB) und Unterlegscheiben (CC) an den Beinen (J).

BB Schraube M6*12		x 4
CC Unterlegscheibe		x 4

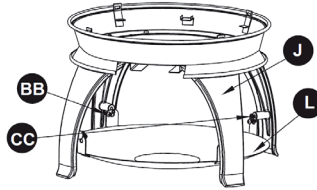

Richten Sie die Tür der Abschirmung (E) am Spalt der unteren Ofenschale (H) aus. Befestigen Sie die Abschirmung (E) mit Unterlegscheiben (CC), Federscheiben (DD), Muttern (AA) und M6 x 15 Schrauben (EE) an der oberen Ofenschale (G).

- AA** Mutter  x 4
- CC** Unterlegscheibe  x 4
- DD** Federscheibe  x 4
- EE** Schraube M6*15  x 4

3

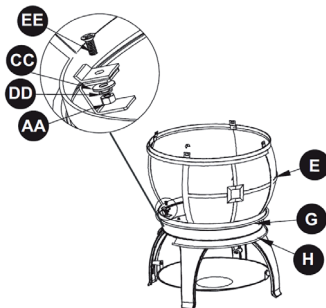

Hängen Sie die Schiebetür (D) an die Stützleiste der Abschirmung (E).

4

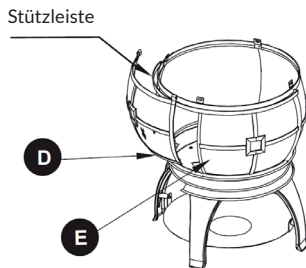

Befestigen Sie den Schornstein (C) mit Unterlegscheiben (CC), Federscheiben (DD), M6 x 20 Schrauben (FF) und Muttern (AA) an der Oberseite der Abschirmung (E).

- AA** Mutter  x 4
- CC** Unterlegscheibe  x 4
- DD** Federscheibe  x 4
- FF** Schraube M6*15  x 4

5

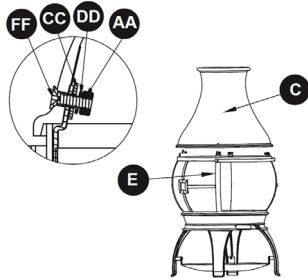

6

Legen Sie das Kohlengitter (F) in die obere Ofenschale (G) und befestigen Sie es an der Halterung. Setzen Sie dann die Netzabdeckung (B) und Schornsteinkappe (A) auf den Schornstein (C).

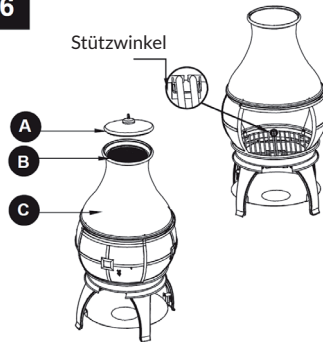

7

Schieben Sie den Aschebehälter (I) in die obere Schiene. Legen Sie den Schürhaken (K) auf das Feuerholz-Regal (L).

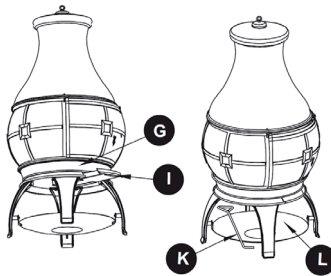

So entzünden Sie das Feuer

Öffnen Sie die Schiebetür und legen Sie die Holzscheite (etwa 1,5 kg) auf das Kohlengitter.

Hinweis: Achten Sie darauf, dass das Holz mittig auf dem Gitter liegt und nicht bis an den Rand des Gitters reicht. Das Holz sollte nicht höher als 35 cm gestapelt werden.

Legen Sie dann leichte, trockene Holzsnitzel unter die Holzscheite und schließen Sie die Schiebetür.

REINIGUNG UND PFLEGE



VORSICHT

Verbrennungsgefahr! Lassen Sie den Gartenkamin vollständig abkühlen, bevor Sie ihn auf Schäden untersuchen oder reinigen.

Den Gartenkamin auf Schäden untersuchen

Überprüfen Sie den Gartenkamin regelmäßig auf Schäden, um die Produktsicherheit und eine längere Lebensdauer zu gewährleisten.

1. Überprüfen Sie alle Teile, um sicherzustellen, dass sie fest sitzen.
2. Prüfen Sie die Komponenten auf Beschädigungen und Rost.
3. Wenn Sie Schäden an einer Komponente feststellen, lassen Sie den Kamin reparieren, bevor Sie ihn weiter benutzen.

Reinigung

- Versichern Sie sich, dass das Feuer vollständig gelöscht ist, wenn Sie den Gartenkamin nicht mehr verwenden.
- Stellen Sie sicher, dass das Feuer vollständig gelöscht ist und der Kamin abgekühlt ist, bevor Sie den Aschebehälter reinigen. Kehren Sie die Asche in den Aschebehälter, ziehen Sie den Aschebehälter heraus und entleeren Sie ihn.
- Verwenden Sie ein feuchtes Baumwolltuch, um Ruß von der Netzabdeckung und der Schornsteinkappe zu entfernen. Reinigen Sie den Kamin regelmäßig, um eine lange Lebensdauer zu gewährleisten.

Hinweis: Nach mehrmaligem Gebrauch kann sich die Oberfläche verfärben.

- Reinigen Sie den Kamin erst, wenn das Feuer vollständig ausgebrannt und der Kamin abgekühlt ist.
- Verwenden Sie keinen Ofenreiniger oder Scheuermittel, da diese das Produkt beschädigen können.
- Reinigen Sie die Außenseite mit Wasser und einem milden Geschirrspülmittel.
- Verwenden Sie bei hartnäckigen Flecken einen Reiniger auf Zitrusbasis und eine Nylon-Bürste.

So verstauen Sie den Kamin

Hinweis: Verstauen Sie den Kamin erst, wenn das Feuer vollständig ausgebrannt und der Kamin abgekühlt ist.

- Sobald das Feuer erloschen ist und sich die Asche und der Kamin abgekühlt haben, entfernen Sie die Asche und entsorgen Sie sie.
- Decken Sie den Kamin mit der PVC-Abdeckung ab.
- Verstauen Sie den Kamin zusammengebaut an einem Ort außerhalb der Reichweite von Kindern und Haustieren .
- Wenn Sie keine Abdeckung verwenden, verstauen Sie den Kamin an einem trockenen Ort.

Dear Customer,

Congratulations on purchasing this equipment. Please read this manual carefully and take care of the following hints to avoid damages. Any failure caused by ignoring the items and cautions mentioned in the instruction manual is not covered by our warranty and any liability. Scan the QR code to get access to the latest user manual and other information about the product



CONTENT

Safety Instructions 14
Product Overview 15
Hardware Contents 16
Assembly 16
Cleaning and Care 20

MANUFACTURER & IMPORTER (UK)

Manufacturer:

Chal-Tec GmbH, Wallstrasse 16, 10179 Berlin, Germany.

Importer for Great Britain:

Chal-Tec UK limited
Unit 6 Riverside Business Centre
Brighton Road
Shoreham-by-Sea
BN43 6RE
United Kingdom

SAFETY INSTRUCTIONS

**WARNING**

Risk of suffocation! This fire pit is for outdoor use only and shall not be used in a building, garage or any other enclosed area. Toxic carbon monoxide fumes can accumulate and cause asphyxiation.



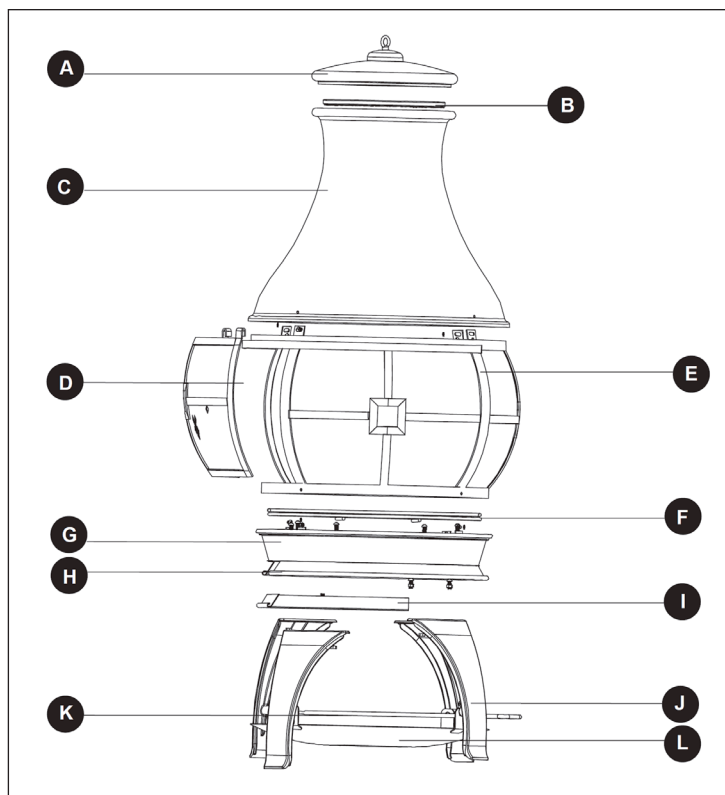

- This fire pit is not for commercial use.
- This fire pit should only be used by adults and all children and pets should be kept at a safe distance.
- Do not use petrol, white spirit, lighter fluid, alcohol or other similar chemicals to light a fire as a rapid increase in temperature could damage the fire pit. This fire pit is only suitable for use with charcoal, untreated wood or dry logs. Do not use coal.
- Do not use this fire pit until it is completely assembled and all parts are securely fastened and tightened.
- Do not use the fire pit on decking or any other flammable surfaces such as dry grass, wood chips, leaves.
- Always empty this fire pit after use. Leave a thin layer of ash to protect the bottom. Do not remove ashes or charcoal until they are completely and fully extinguished.
- Do not touch the fire pit until it is completely cooled unless you are wearing heat resistant gloves as it is hot when in use.
- Do not handle or move the fire pit when in use as it is hot.
- Do not attempt to store the fire pit until all ashes and charcoals are completely extinguished.
- Always use a safety tool and heat resistant gloves when adding or moving fuel.
- Do not leave a burning fire unattended.
- Fire hazard-Hot embers may emit while in use.
- Do not overload the fire pit with fuel. Do not add additional fuel until the fire burns down. If a portion of the fire bowl is growing red, it is overloaded.
- Do not burn fuel directly on the fire bowl base.
- Do keep the fuel away from the wall of the fire pit as the high temperature may damage it.
- Avoid breathing smoke from the fire and avoid getting it into your eyes.
- Always thoroughly inspect the fire pit before use.
- A slight discolouration of finish may occur after use.

PRODUCT OVERVIEW

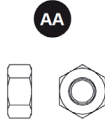
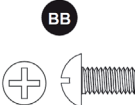
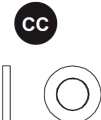

A	Chimney cap (1x)	G	Upper stove assembly (1x)
B	Chimney mesh cover (1x)	H	Lower stove bowl (1x)
C	Chimney body (1x)	I	Ash tray assembly (1x)
D	Sliding door assembly (1x)	J	Leg (4x)
E	Screen assembly (1x)	K	Poker (1x)
F	Charcoal grid (2x)	L	Log rack assembly (1x)

HARDWARE CONTENTS

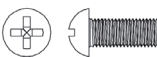
			
<p>Nut (16x)</p>	<p>M6*12 mm Screw (4x)</p>	<p>Washer (20x)</p>	<p>Spring washer (16x)</p>
			
<p>Flat bolt M6*15 mm (4x)</p>	<p>Flat bolt M6*20 mm (4x)</p>	<p>Srew M6*15 mm (8x)</p>	

ASSEMBLY

Before assembly

Before assembling product, make sure all parts are present. Compare parts with package contents list and hardware contents above. If any part is missing or damaged, do not attempt to assemble the product. Contact customer service for replacement parts.

Note: Tools required for assembly (not included): Phillips screwdriver, 3/8" wrench. Suggest two people assemble this product.

Assembly

Line up the upper stove assembly (G) and lower stove bowl (H). Position the legs (J) beneath bowl (H) and attach using M6 x 15 mm bolts (GG), nuts (AA), washers (CC) and spring washers (DD).

1

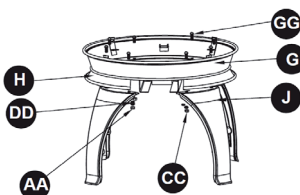

AA Nut x 8



CC Washer x 8



DD Spring washer x 8



GG Screw M6*15 x 8



Place log rack assembly (L) in the center of unit and attach to legs (J) with M6 x 12 mm bolts (BB) and washers (CC).

2

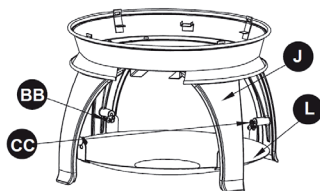

BB Screw M6*12 x 4



CC Washer x 4



Align the door of screen assembly (E) and gap of lower stove bowl (H). Attach the smaller end of screen assembly (E) onto upper stove assembly (G) with washers (CC), spring washers (DD), nuts (AA), and M6 x 15 mm flat bolts (EE).

AA Nut		x 4
CC Washer		x 4
DD Spring washer		x 4
EE Screw M6*15		x 4

3

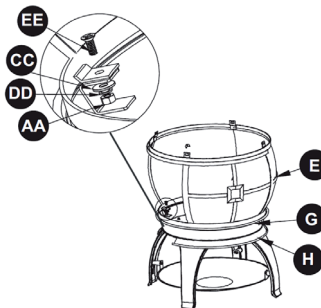



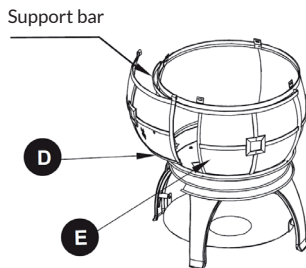

Hang the sliding door assembly (D) onto support bar of screen assembly (E).

4



Attach chimney body (C) on the top of screen assembly (E) with washers (CC), spring washers (DD), M6 x 20 mm flat bolts (FF) and nuts (AA).

AA Nut		x 4
CC Washer		x 4
DD Spring washer		x 4
FF Screw M6*15		x 4

5

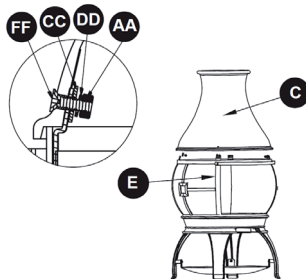

6

Place the charcoal grid (F) in upper stove assembly (G) and attach it onto the support bracket. Then place chimney mesh cover (B) and chimney cap (A) on top of chimney body (C).

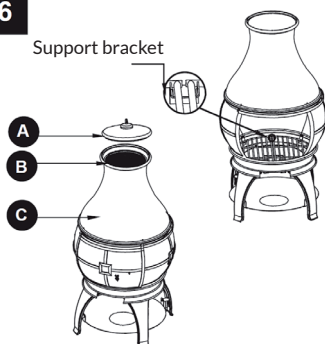

7

Insert the ash tray assembly (I) into the track on upper. Place the poker (K) on the log rack assembly (L).

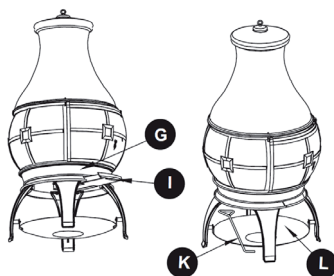

Lighting instructions

Open the sliding door using the poker, and put the logs (less than 1.5 kg) on the charcoal grid.

Note: Make sure log does not extend to the charcoal grid edge, and the log height does not extend 35 cm. The fire height should not extend 3/4 the height of screen.

Light dry wood chips under logs. Close the sliding door with poker.

CLEANING AND CARE

**CAUTION**

Risk of burns! Do not attempt to inspect this outdoor chiminea until the fire is completely out and cooled down.

Inspecting

Inspect this chiminea on a regular basis to ensure product safety and longer product life.

1. Check handles to make sure they are secure.
2. Check components for any signs of damage or rust.
3. If you detect damage to any component, do not operate until you make repairs.

Cleaning

- Make sure the fire is completely out when you are no longer using the chiminea.
- Make sure the fire is completely out before you clean the ash tray. Sweep the ash into the ash tray, pull ash tray out and empty it.
- Use a damp cotton cloth to remove the smoke stain from the mesh cover and chimney cap. Clean this outdoor chiminea on a regular basis to promote safer experiences and longer product life.

Note: After repeated use, the finish may become discolored.

- Do not attempt to clean this outdoor chiminea until the fire is completely out and cooled down.
- Do not use oven cleaner or abrasive cleaners as they will damage this product.
- Do not clean any part of this outdoor chiminea in a self-cleaning oven as it may damage the finish.
- Wipe exterior surface with a mild dishwashing detergent or baking soda.
- For stubborn surface stains use a citrus-based degreaser and a nylon scrubbing brush.
- Rinse clean with water.
- Remove built-up creosote from components with a chiminea cleaning product.

Storage

Note: Do not move or store this outdoor chiminea until the fire is completely out and cooled down.

- Once the fire is out, (coals are cold and outdoor chiminea is cool to touch), remove ashes and properly dispose.
- Cover outdoor chiminea with the PVC cover (M).
- Store assembled in a location away from children and pets.
- If you do not use a cover, store this outdoor chiminea in a dry location to maximize product life.

Chère cliente, cher client,

Toutes nos félicitations pour l'acquisition de ce nouvel appareil. Veuillez lire attentivement et respecter les instructions de ce mode d'emploi afin d'éviter d'éventuels dommages. Nous ne saurions être tenus pour responsables des dommages dus au non-respect des consignes et à la mauvaise utilisation de l'appareil. Scannez le QR-Code pour obtenir la dernière version du mode d'emploi et à d'autres informations concernant le produit:



SOMMAIRE

Consignes de sécurité 24
Aperçu de l'appareil 25
Petits éléments 26
Assemblage 26
Nettoyage et entretien 30

FABRICANT ET IMPORTATEUR (UK)

Fabricant :

Chal-Tec GmbH, Wallstraße 16, 10179 Berlin, Allemagne.

Importateur pour la Grande Bretagne :

Chal-Tec UK limited
Unit 6 Riverside Business Centre
Brighton Road
Shoreham-by-Sea
BN43 6RE
United Kingdom

CONSIGNES DE SÉCURITÉ



MISE EN GARDE

Risque d'étouffement ! La cheminée de jardin est conçue pour usage extérieur seulement. Elle ne doit pas être utilisée dans un bâtiment, garage ou autre espace clos. Il peut se former des fumées toxiques qui provoquent l'étouffement. Die Feuerstelle ist nicht für gewerbliche Zwecke geeignet.



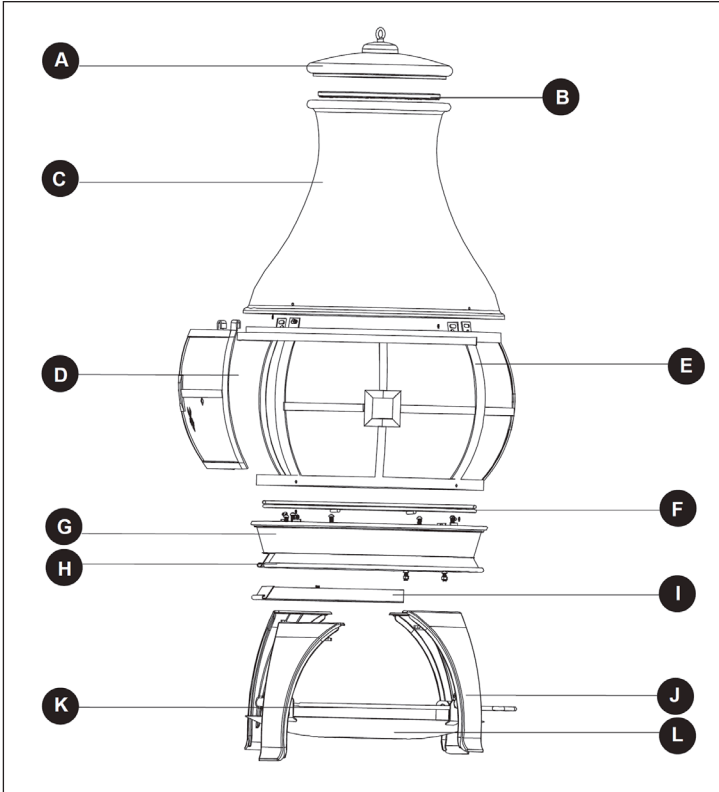

- La cheminée ne convient pas à un usage commercial.
- La cheminée ne doit être utilisée que par des adultes. Les enfants et les animaux de compagnie doivent garder une distance de sécurité.
- N'utilisez pas d'essence, d'alcool à brûler, de liquide léger ou d'alcool pour l'éclairage.
- N'utilisez pas la cheminée tant qu'elle n'est pas complètement assemblée avec toutes les pièces bien serrées.
- N'utilisez pas la cheminée sur du bois ou d'autres matériaux combustibles.
- Videz la cheminée après chaque utilisation. Laissez une fine couche de cendres pour protéger le sol. Ne retirez les cendres que lorsque le charbon a complètement brûlé et que les cendres se sont refroidies.
- Ne touchez pas la cheminée tant qu'elle n'a pas complètement refroidi ; portez des gants résistants à la chaleur pendant le fonctionnement.
- Ne rangez la cheminée que lorsqu'elle est complètement refroidie et que les cendres ont été éliminées.
- Utilisez toujours des outils et des gants résistants à la chaleur lorsque vous ajoutez du combustible ou que vous déplacez la cheminée.
- Ne laissez pas la cheminée sans surveillance pendant l'utilisation.
- Les braises chaudes peuvent tomber de la cheminée pendant leur utilisation.
- Ne surchargez pas la cheminée avec du combustible. Ajoutez du nouveau combustible seulement lorsque le feu a brûlé. Si une partie du braséro rougeoie, cela indique qu'il est surchargé.
- Ne posez pas le combustible directement sur le fond du foyer.
- Éloignez le combustible de la paroi de la cheminée, car les hautes températures peuvent endommager la paroi.
- Ne respirez pas la fumée et ne la laissez pas entrer dans vos yeux.
- Inspectez la cheminée pour vous assurer qu'elle n'est pas endommagée avant de l'utiliser.
- La surface métallique peut légèrement se décolorer au fur et à mesure de l'utilisation.

APERÇU DE L'APPAREIL

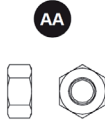
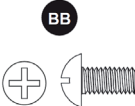
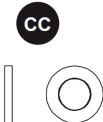

A	Tuyau de cheminée (1x)	G	Four braséro supérieur (1x)
B	Couvercle grillagé (1x)	H	Four braséro inférieur (1x)
C	Cheminée (1x)	I	Récupérateur de cendres (1x)
D	Porte coulissante (1x)	J	Pied (4x)
E	Bouclier (1x)	K	Tisonnier (1x)
F	Grille à charbon (2x)	L	Etagère à bois de cheminée (1x)

PETITS ÉLÉMENTS

			
<p>écrous (16x)</p>	<p>Vis M6*12 mm (4x)</p>	<p>Rondelles (20x)</p>	<p>Rondelles à ressort (16x)</p>
			
<p>Vis plate M6*15 mm (4x)</p>	<p>Vis plate M6*20 mm (4x)</p>	<p>Vis M6*15 mm (8x)</p>	

ASSEMBLAGE

Avant l'assemblage

Assurez-vous que toutes les pièces sont présentes avant l'assemblage. Comparez les pièces avec la liste des éléments. Si une pièce est manquante ou endommagée, n'essayez pas d'assembler le produit. Contactez le service client.

Remarque : Pour l'assemblage, vous aurez besoin d'un tournevis cruciforme et d'une clé de 3/8 „. Demandez l'aide d'une deuxième personne pour l'assemblage.

Assemblage

Alignez le four braséro supérieur (G) avec le four braséro inférieur (H). Fixez les pieds (J) aux coques du braséro avec les vis M6 x 15 (GG), les écrous (AA), les rondelles (CC) et les rondelles à ressort (DD).

1

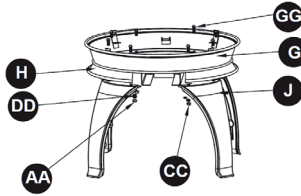

AA Ecrou			x 8
CC Rondelle			x 8
DD Rondelle à ressort			x 8
GG Vis M6*15			x 8

Placez l'étagère en bois de chauffage (L) au centre de l'unité et fixez-la aux pieds (J) avec M6 x 12 (BB) et les rondelles (CC)..

2

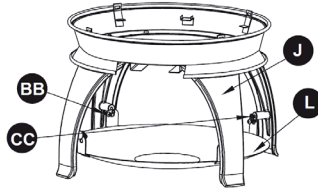

BB Vis M6*12			x 4
CC Rondelle			x 4

Alignez la porte du bouclier (E) avec l'espace de la coque inférieure du four (H). Fixez le bouclier (E) avec les rondelles (CC), les rondelles à ressort (DD), écrous (AA) et vis M6 x 15 (EE) sur la coque supérieure du four (G)

AA Ecrou		x 4
CC Rondelle		x 4
DD Rondelle à ressort		x 4
EE Vis M6*15		x 4

3

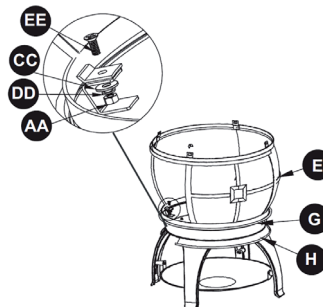



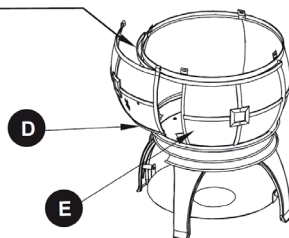

Accrochez la porte coulissante (D) sur la bande de support du bouclier (E).

4

Bande de support



Fixez la cheminée (C) avec les rondelles (CC), les rondelles à ressort (DD), les vis M6 x 20 (FF) et les écrous (AA) au sommet du bouclier (E).

AA Ecrou		x 4
CC Rondelle		x 4
DD Rondelle à ressort		x 4
FF Vis M6*15		x 4

5

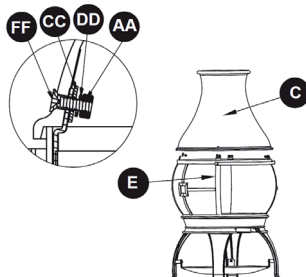

6

Placez la grille à charbon (F) dans la coque du four supérieur (G) et fixez-la au support. Ensuite, insérez le couvercle en maille (B) et le chapeau de cheminée (A) sur la cheminée (C).

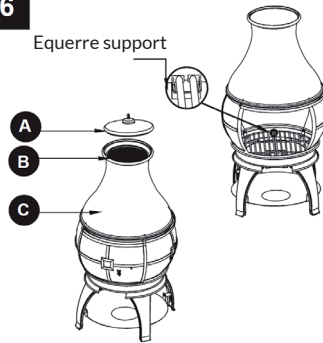

7

Faites glisser le conteneur de cendres (I) sur le rail supérieur. Mettez le tisonnier (K) sur l'étagère de bois de chauffage (L).

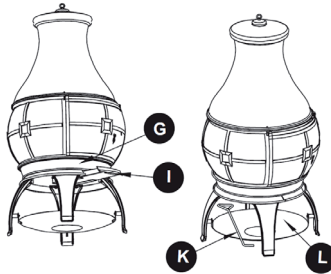

Comment allumer le feu

Ouvrez la porte coulissante et placez les bûches (environ 1,5 kg) sur la grille à charbon.

Remarque : Veillez à ce que le bois soit centré sur la grille et n'atteigne pas le bord de la grille. Le bois ne doit pas être empilé sur plus de 35 cm.

Ensuite, placez des copeaux de bois secs et légers sous les bûches et fermez la porte coulissante.

NETTOYAGE ET ENTRETIEN



ATTENTION

Risque de brûlure ! Laissez la cheminée refroidir entièrement avant de l'examiner pour rechercher d'éventuels défauts ou de la nettoyer.

Contrôle du bon état de la cheminée

Vérifiez régulièrement la cheminée du jardin pour déceler tout dommage afin d'assurer la sécurité du produit et une plus longue durée de vie.

1. Vérifiez les poignées pour vous assurer qu'elles sont bien serrées.
2. Vérifiez que les éléments sont exempts de dommages et de rouille.
3. Si vous remarquez des dommages sur un élément, faites réparer la cheminée avant de continuer à l'utiliser.

Nettoyage

- Assurez-vous que le feu est complètement éteint lorsque vous cessez d'utiliser la cheminée de jardin.
- Assurez-vous que le feu est complètement éteint et que la cheminée s'est refroidie avant de nettoyer le bac à cendres. Remettez les cendres dans le conteneur à cendres, sortez le conteneur à cendres et videz-le.
- Utilisez un chiffon en coton humide pour enlever la suie du couvercle grillagé et du chapeau de cheminée. Nettoyez la cheminée régulièrement pour lui assurer une grande longévité.

Remarque : les surfaces sont susceptibles de se décolorer après plusieurs utilisations.

- Ne nettoyez pas la cheminée tant que le feu ne s'est pas complètement éteint et que la cheminée n'est pas refroidie.
- N'utilisez pas de nettoyeur pour four ou de nettoyeurs abrasifs, car ils pourraient endommager le produit.
- Nettoyez l'extérieur avec de l'eau et un produit vaisselle doux.
- Pour les taches tenaces, utilisez un nettoyeur à base d'agrumes et une brosse en nylon.

Comment ranger la cheminée

Remarque : Ne rangez la cheminée que lorsque le feu est complètement éteint et que la cheminée est refroidie.

- Une fois le feu éteint et les cendres et la cheminée refroidies, enlevez les cendres et jetez-les.
- Couvrez la cheminée avec le couvercle en PVC.
- Rangez la cheminée assemblée dans un endroit hors de portée des enfants et des animaux domestiques.
- Si vous n'utilisez pas le couvercle, rangez la cheminée dans un endroit sec.

Estimado cliente,

Le felicitamos por la adquisición de este producto. Lea atentamente el siguiente manual y siga cuidadosamente las instrucciones de uso con el fin de evitar posibles daños. La empresa no se responsabiliza de los daños ocasionados por un uso indebido del producto o por haber desatendido las indicaciones de seguridad. Escanee el código QR para obtener acceso al manual de usuario más reciente y otra información sobre el producto:



ÍNDICE

Indicaciones de seguridad 34
Vista general del aparato 35
Piezas pequeñas 36
Montaje 36
Limpieza y cuidado 40

FABRICANT ET IMPORTATEUR (UK)

Fabricant :

Chal-Tec GmbH, Wallstraße 16, 10179 Berlin, Allemagne.

Importateur pour la Grande Bretagne :

Chal-Tec UK limited
Unit 6 Riverside Business Centre
Brighton Road
Shoreham-by-Sea
BN43 6RE
United Kingdom

INDICACIONES DE SEGURIDAD



ADVERTENCIA

Riesgo de asfixia. La chimenea de jardín está concebida para utilizarse únicamente en el exterior. No debe utilizarse en un edificio, garaje o área cerrada. Se pueden crear humos tóxicos y provocar asfixia. La cheminée ne convient pas à un usage commercial.



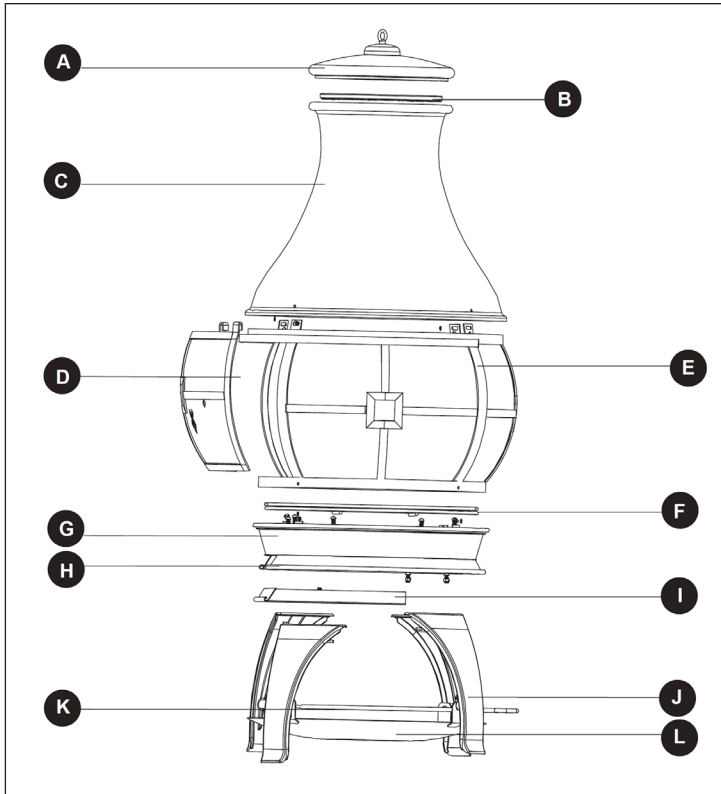

- La chimenea no está diseñada para fines comerciales.
- Solamente un adulto debe operar la chimenea. Mantenga a niños y mascotas a una distancia segura.
- No utilice gasolina, alcohol, gasolina para encendedores ni otros líquidos explosivos para encender la chimenea.
- Utilice la chimenea únicamente después de haberla montado completamente y comprobado que todas sus piezas están correctamente atornilladas.
- No instale la chimenea en superficies hechas de madera u otros materiales inflamables.
- Vacíe la chimenea después de cada uso. Deje una capa fina de cenizas para proteger el fondo. Retire las cenizas cuando las brasas se hayan apagado y la chimenea se haya enfriado.
- No toque la chimenea hasta que se haya enfriado; utilice guantes resistentes al calor durante el manejo de la misma.
- Guarde la chimenea después de que se haya enfriado y haya retirado las cenizas.
- Utilice siempre utensilios y guantes resistentes al calor cuando añada el material combustible o mueva la chimenea.
- No deje la chimenea sin supervisión cuando está encendida.
- Durante el uso, puede salir brasa muy caliente de la chimenea.
- No llene en exceso la chimenea con material de combustión. Añada más material combustible cuando el fuego se está apagando. Si una parte del cuenco para fuego se ilumina en rojo, significa que está lleno en exceso.
- No ponga el material combustible directamente en el fondo de la chimenea.
- No coloque el material combustible cerca de las paredes de la chimenea, ya que las altas temperaturas las podrían dañar.
- No inhale el humo y evite que entre en contacto con sus ojos.
- Examine la chimenea antes de cada uso para detectar cualquier deterioro.
- La superficie de metal puede decolorarse un poco por el uso.

VISTA GENERAL DEL APARATO

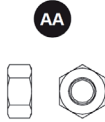
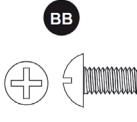
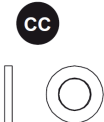

A	Tapa de chimenea (1)	G	Bandeja superior (1)
B	Tapa de rejilla (1)	H	Bandeja inferior (1)
C	Chimenea (1)	I	Bandeja de cenizas (1)
D	Puerta (1)	J	Patas (4)
E	Placa protectora (1)	K	Atizador (1)
F	Rejilla de carbón (2)	L	Bandeja de leña (1)

PIEZAS PEQUEÑAS

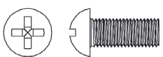
			
<p>Tuerca (16x)</p>	<p>Tornillo M6*12 mm (4x)</p>	<p>Arandela (20x)</p>	<p>Arandela de muelle (16x)</p>
			
<p>Tornillo de cabeza plana M6*15 mm (4x)</p>	<p>Tornillo de cabeza plana M6*20 mm (4x)</p>	<p>Tornillo M6*15 mm (8x)</p>	

MONTAJE

Antes del montaje

Asegúrese antes del montaje de que todas las piezas están suministradas. Compare las piezas. Si no dispone de una pieza o si está defectuosa, no monte el producto. Póngase en contacto con el servicio de atención al cliente.

Atención: necesitará un destornillador estrella y una llave de tuercas de 3/8" para el montaje. Pida ayuda a una segunda persona para montar el aparato.

Montaje

Monte la bandeja superior (G) y la bandeja inferior (H). Fije las patas (J) en la bandeja con tornillos M6 x 15 (GG), tuercas (AA), arandelas (CC) y arandelas de muelle (DD).

1

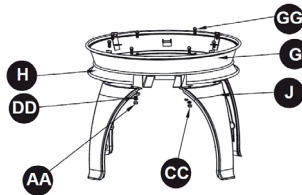

AA Tuerca x 8



CC Arandela x 8



DD Arandela de muelle x 8



GG Tornillo M6*15 x 8



Instale en medio la bandeja de leña (L) y fíjela con tornillos M6 x 12 (BB) y arandelas (CC) a las patas (J).

2

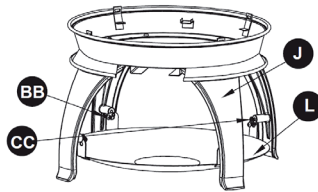

BB Tornillo M6*12 x 4



CC Arandela x 4



Alinee las placas protectoras (E) con la bandeja inferior (H). Fije las placas protectoras (E) con arandelas (CC), arandelas de muelle (DD), tuercas (AA) y tornillos M6 x 15 (EE) a la bandeja superior (G).

AA Tuerca		x 4
CC Arandela		x 4
DD Arandela de muelle		x 4
EE Tornillo M6*15		x 4

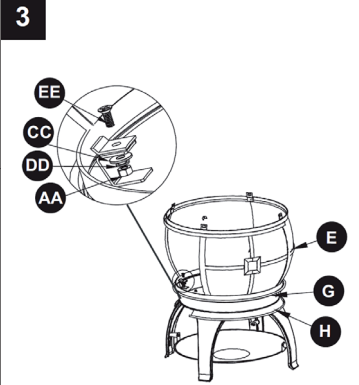

Cuelgue la puerta (D) en la barra de soporte de las placas protectoras (E).

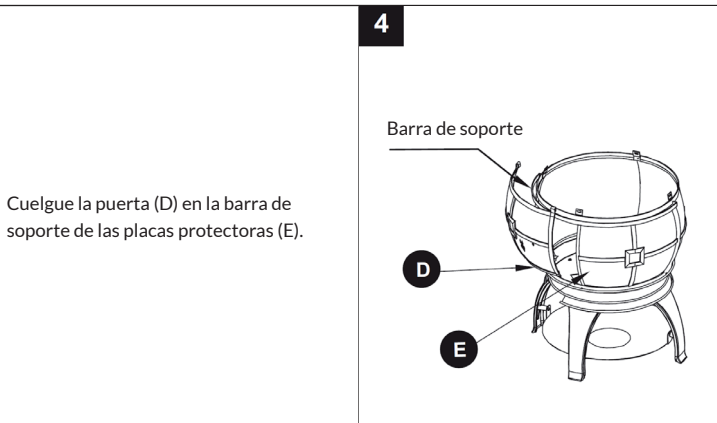

Monte la chimenea (C) en la parte superior de las placas (E) con la ayuda de arandelas (CC), arandelas de muelle (DD), tornillos M6 x 20 (FF) y tuercas (AA).

AA Tuerca		x 4
CC Arandela		x 4
DD Arandela de muelle		x 4
FF Tornillo M6*15		x 4

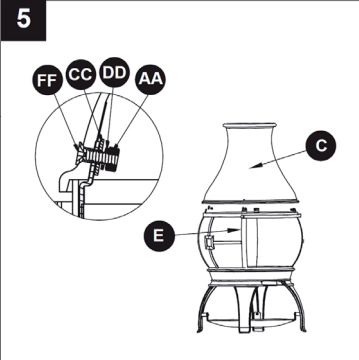

6

Coloque la rejilla de carbón (F) en la bandeja superior (G) y fíjela al soporte. A continuación, coloque la tapa de rejilla (B) y la tapa de chimenea (A) en la chimenea (C).

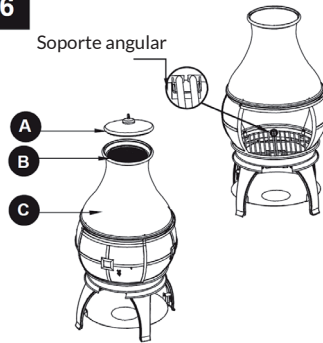

7

Inserte la bandeja de cenizas (I) en el carril superior. Coloque el atizador (K) en la bandeja de leña (L).

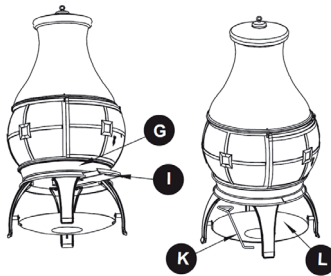

Encender el fuego

Abra la puerta e introduzca haz de leña (aprox. 1,5 kg) en la rejilla de carbón.

Atención: asegúrese de que la leña se encuentra en el centro de la rejilla y no en los bordes. Asegúrese de que la leña apilada no supere los 35 cm de altura.

A continuación, inserte trocitos de madera ligeros y secos debajo del haz de leña y cierre la puerta.

LIMPIEZA Y CUIDADO



¡ATENCIÓN!

¡Riesgo de quemaduras! Deje que la chimenea se enfríe por completo antes de limpiarla o examinarla para detectar cualquier deterioro.

Examinar la chimenea

Inspeccione regularmente la chimenea para detectar posibles daños y, de este modo, garantizar la seguridad del producto y una mayor vida útil.

1. Inspeccione las asas para asegurar que están bien atornilladas.
2. Revise las piezas para detectar cualquier deterioro u oxidación.
3. Si detecta cualquier deterioro, repárelo antes de volver a utilizar la chimenea.

Limpieza

- Compruebe que el fuego está completamente apagado si no utiliza más la chimenea.
- Asegúrese de que el fuego está completamente apagado y la chimenea enfriada antes de limpiar la bandeja de cenizas. Reúna las cenizas en la bandeja de cenizas, retire la bandeja y vacíela.
- Utilice un paño de algodón húmedo para retirar el hollín de la tapa de rejilla y la tapa de chimenea. Limpie regularmente la chimenea para asegurar una mayor vida útil.

Atención: la superficie puede decolorarse después de varios usos.

- Limpie la chimenea después de que el fuego se haya apagado completamente y la chimenea se haya enfriado.
- No utilice limpiadores de horno o productos de limpieza abrasivos, ya que podría dañar la chimenea.
- Limpie el exterior con agua y un detergente para lavavajillas suave.
- Utilice un producto de limpieza a base de limón y un cepillo de nailon para eliminar manchas difíciles.

Guardar la chimenea

Atención: guarde la chimenea después de que el fuego se haya apagado completamente y la chimenea se haya enfriado.

- Retire las cenizas cuando el fuego se haya apagado y la chimenea, enfriado.
- Cubra la chimenea con una funda de PVC.
- Guarde la chimenea montada en un lugar fuera del alcance de los niños.
- Si no utiliza una funda, guarde la chimenea en un lugar seco.

Gentile Cliente,

La ringraziamo per aver acquistato il dispositivo. La preghiamo di leggere attentamente le seguenti istruzioni per l'uso e di seguirle per evitare possibili danni tecnici. Non ci assumiamo alcuna responsabilità per danni scaturiti da una mancata osservazione delle avvertenze di sicurezza e da un uso improprio del dispositivo. Scansionare il codice QR seguente, per accedere al manuale d'uso più attuale e per ricevere informazioni sul prodotto.



INDICE

Avvertenze di sicurezza 44
Descrizione del prodotto 45
Componenti piccoli 46
Montaggio 46
Pulizia e manutenzione 50

PRODUTTORE E IMPORTATORE (UK)

Produttore:

Chal-Tec GmbH, Wallstraße 16, 10179 Berlino, Germania.

Importatore per la Gran Bretagna:

Chal-Tec UK limited
Unit 6 Riverside Business Centre
Brighton Road
Shoreham-by-Sea
BN43 6RE
United Kingdom

AVVERTENZE DI SICUREZZA



ATTENZIONE

Pericolo di soffocamento! Il camino da giardino è progettato per il solo uso all'aperto. Non può essere utilizzato in edifici, garage o altri ambienti chiusi. Possono formarsi vapori tossici, che provocano il soffocamento.



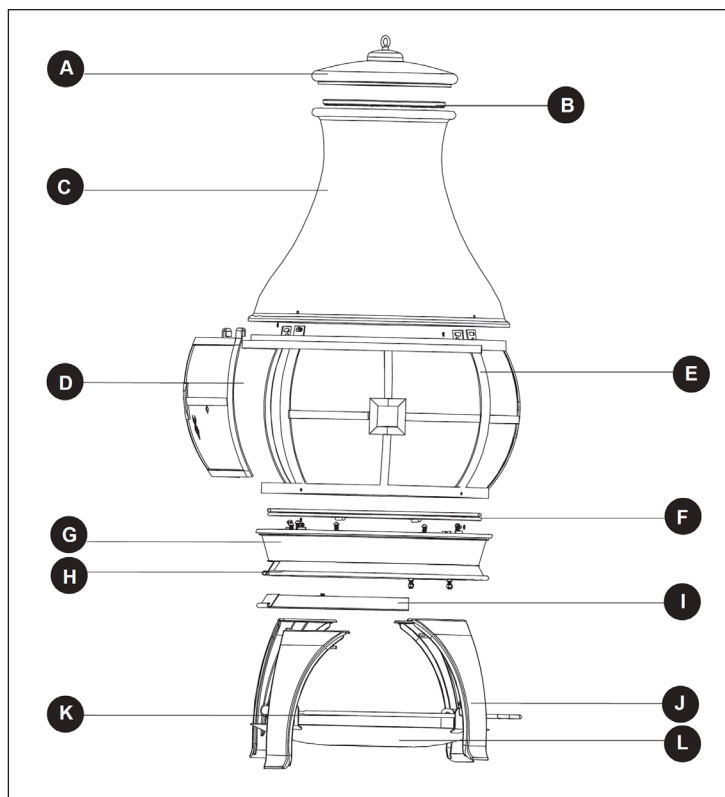

- Il camino non è adatto a utilizzi commerciali.
- Il camino può essere utilizzato solo da persone adulte. Tenere bambini e animali domestici a distanza di sicurezza.
- Non utilizzare benzina, spirito, liquido per accendini o alcool per accenderlo.
- Non utilizzare il camino prima del completo montaggio e prima che tutti i componenti siano saldamente assemblati.
- Non utilizzare il camino su fondi in legno o in altri materiali infiammabili.
- Svuotare il camino dopo ogni utilizzo. Lasciare un sottile strato di cenere all'interno per proteggere il fondo. Togliere la cenere solo quando il carbone è completamente bruciato e la cenere si è raffreddata.
- Toccare il camino solo quando è completamente raffreddato. Durante l'utilizzo, indossare guanti termoresistenti.
- Riporre il camino solo quando è completamente raffreddato ed è stata rimossa la cenere.
- Quando si aggiunge materiale combustibile o si sposta il camino, utilizzare sempre utensili e guanti termoresistenti.
- Non lasciare il camino privo di controllo durante il funzionamento.
- Durante il funzionamento, possono cadere braci fuori dal camino.
- Non sovraccaricare il camino con materiale combustibile. Aggiungere combustibile solo quando il fuoco è debole. Se alcune parti del camino diventano rosse a causa dell'eccessivo calore, è stato inserito troppo materiale combustibile.
- Tenere il combustibile lontano dalla parete del camino, in quanto temperature elevate potrebbero danneggiarla.
- Non inspirare il fumo e non farlo arrivare negli occhi.
- Controllare il camino prima dell'utilizzo per eventuali danneggiamenti.
- L'utilizzo può causare un cambiamento di colore delle superfici metalliche.

DESCRIZIONE DEL PRODOTTO

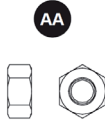
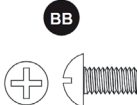
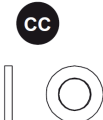

A	Coperchio del comignolo (1x)	G	Vano di combustione superiore (1x)
B	Copertura a rete (1x)	H	Vano di combustione inferiore (1x)
C	Comignolo (1x)	I	Contenitore della cenere (1x)
D	Sportello scorrevole (1x)	J	Gambe (4x)
E	Schermatura (1x)	K	Attizzatoio (1x)
F	Griglie per il carbone (2x)	L	Ripiano per legna da ardere (1x)

COMPONENTI PICCOLI

			
<p>Dadi (16x)</p>	<p>Viti M6*12 mm (4x)</p>	<p>Rondelle (20x)</p>	<p>Rosette elastiche (16x)</p>
			
<p>Viti piatte M6*15 mm (4x)</p>	<p>Viti piatte M6*20 mm (4x)</p>	<p>Viti M6*15 mm (8x)</p>	

MONTAGGIO

Prima del montaggio

Prima del montaggio, assicurarsi che siano presenti tutti i componenti. Comparare i componenti presenti con la lista sovrastante. Se un componente manca o è danneggiato, non cercare di montare il prodotto. Rivolgersi al servizio di assistenza ai clienti.

Avvertenza: per il montaggio sono necessari un cacciavite a croce e una chiave inglese 3/8". Chiedere l'aiuto di una seconda persona per il montaggio.

Montaggio

Posizionare il vano di combustione superiore (G) su quello inferiore (H). Fissare le gambe (J) al vano di combustione con viti M6x15 (GG), dadi (AA), rondelle (CC) e rosette elastiche (DD).

1

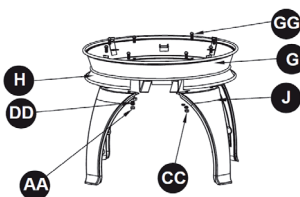

AA Dado x 8



CC Rondelle x 8



DD Rosette elastiche x 8



GG Viti M6*15 x 8



Posizionare il ripiano per la legna da ardere al centro del dispositivo e fissarlo alle gambe con viti M6x12 (BB) e rondelle (CC).

2

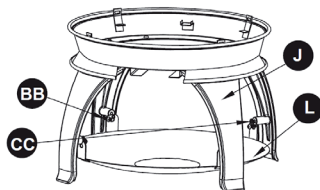

BB Viti M6*12 x 4



CC Rosette elastiche x 4



Posizionare lo sportello della schermatura (E) sulla fenditura del vano inferiore (H).
Fissare la schermatura al vano superiore (G) con rondelle (CC), rosette elastiche (DD), dadi (AA) e viti M6x15 (EE).

AA	Dado		x 4
CC	Rondelle		x 4
DD	Rosette elastiche		x 4
EE	Viti M6*15		x 4

3

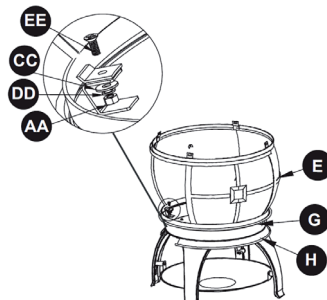



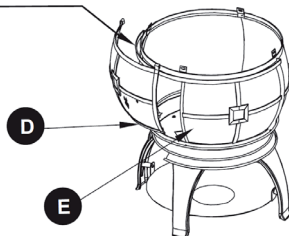

Posizionare lo sportello scorrevole (D) sull'asta di supporto (E)

4

Barra di supporto



Fissare il comignolo (C) alla parte superiore della schermatura (E) con rondelle (CC), rosette elastiche (DD), viti M6x20 (FF) e dadi (AA)

AA	Dado		x 4
CC	Rondelle		x 4
DD	Rosette elastiche		x 4
FF	Viti M6*15		x 4

5

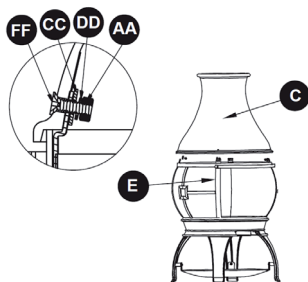

6

Mettere la griglia per il carbone (F) nel vano superiore (G) e fissarla al supporto. Posizionare poi copertura a rete (B) e coperchio del comignolo (A) sul comignolo (C).

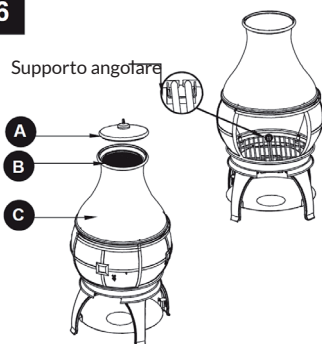

7

Inserire il contenitore della cenere (I) nella guida superiore. Poggiare l'attizzatoio (K) sul ripiano per la legna da ardere (L).

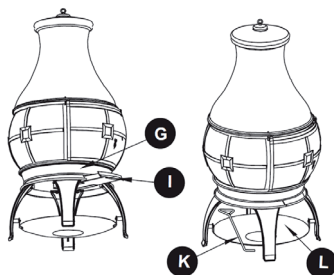

Come accendere il fuoco

Aprire lo sportello scorrevole e poggiare i ceppi (circa 1,5 kg) sulla griglia.

Avvertenza: assicurarsi di posizionare il legno al centro della griglia e non fino al bordo. La legna non deve essere impilata oltre a un'altezza di 35 cm..

Mettere poi pezzetti di legno secco sotto ai ceppi e chiudere lo sportello.

PULIZIA E MANUTENZIONE



ATTENZIONE

Pericolo di ustione! Far raffreddare completamente il camino, prima di controllarlo per eventuali danni o di pulirlo.

Controllare il camino

Controllare regolarmente se il camino è danneggiato, in modo da garantire sicurezza e una lunga vita utile.

1. Controllare le impugnature per assicurarsi che siano fissate saldamente.
2. Controllare se i componenti sono arrugginiti o danneggiati.
3. Se si nota un componente danneggiato, far riparare il camino prima di utilizzarlo.

Pulizia

- Assicurarsi che il fuoco sia completamente spento, quando non si utilizza più il camino.
- Assicurarsi che il fuoco sia completamente spento e che il camino si sia raffreddato, prima di pulire il contenitore della cenere. Mettere la cenere nel contenitore con uno scopino, togliere il contenitore e svuotarlo.
- Utilizzare un panno in cotone umido per rimuovere fuliggine dalla copertura in rete e dal coperchio del comignolo. Pulire regolarmente il camino per garantire una lunga vita utile.

Avvertenza: dopo diversi utilizzi, la superficie può cambiare colore.

- Pulire il camino solo quando il fuoco è completamente spento e il camino si è raffreddato.
- Non utilizzare detersivi per forno o prodotti abrasivi, in quanto potrebbero danneggiare il prodotto.
- Pulire la superficie esterna con acqua e un detersivo per piatti delicato.
- In caso di macchie ostinate, utilizzare una spazzola di nylon e un detersivo a base di agrumi.

Conservare il camino

Avvertenza: riporre il camino solo quando il fuoco è completamente spento e il camino si è raffreddato.

- Non appena il fuoco si è spento e la cenere e il camino si sono raffreddati, rimuovere e smaltire la cenere.
- Coprire il camino con la copertura in PVC.
- Riporre il camino montato in un luogo fuori dalla portata di bambini e animali domestici.
- Se non si utilizza la copertura, riporre il camino in un luogo asciutto.

