



blumfeldt



Titania Dining Set

Rattan Gartengarnitur

Salon de jardin en rotin

Juego de jardín Polyrattan

Set da giardino in rattan

10033331 10033332 10033333 10033334

10033335 10033336 10033337 10033338 10033339

Sehr geehrter Kunde,

wir gratulieren Ihnen zum Erwerb Ihres Gerätes. Lesen Sie die folgenden Hinweise sorgfältig durch und befolgen Sie diese, um möglichen Schäden vorzubeugen. Für Schäden, die durch Missachtung der Hinweise und unsachgemäßen Gebrauch entstehen, übernehmen wir keine Haftung. Scannen Sie den folgenden QR-Code, um Zugriff auf die aktuellste Bedienungsanleitung und weitere Informationen rund um das Produkt zu erhalten:

**Dear Customer,**

Congratulations on purchasing this device. Please read the following instructions carefully and follow them to prevent possible damages. We assume no liability for damage caused by disregard of the instructions and improper use. Scan the QR code to get access to the latest user manual and more product information.

**Chère cliente, cher client,**

Toutes nos félicitations pour l'acquisition de ce nouvel appareil. Veuillez lire attentivement et respecter les instructions de ce mode d'emploi afin d'éviter d'éventuels dommages. Nous ne saurions être tenus pour responsables des dommages dus au non-respect des consignes et à la mauvaise utilisation de l'appareil. Scannez le QR-Code pour obtenir la dernière version du mode d'emploi et des informations supplémentaires concernant le produit.

**Estimado cliente,**

Le felicitamos por la adquisición de este producto. Lea atentamente las siguientes instrucciones y sígalas para evitar posibles daños. No asumimos ninguna responsabilidad por los daños causados por el incumplimiento de las instrucciones y el uso inadecuado. Escanee el siguiente código QR para obtener acceso a la última guía del usuario y más información sobre el producto.

**Gentile cliente,**

La ringraziamo per aver acquistato il dispositivo. La preghiamo di leggere attentamente le seguenti istruzioni per l'uso e di seguirle per evitare possibili danni. Non ci assumiamo alcuna responsabilità per danni scaturiti da una mancata osservazione delle avvertenze di sicurezza e da un uso improprio del dispositivo. Scansionare il codice QR seguente, per accedere al manuale d'uso più attuale e per ricevere informazioni sul prodotto.



ARTIKEL

Artikelnummer	10033331, 10033332
Separat erhältliches Zubehör:	
Sitzkissen	10033333 (grau), 10033334 (beige), 10033335 (braun),
Sitzkissenbezüge	10033336 (grau), 10033337 (beige), 10033338 (braun)
Schutzabdeckung	10033339

ITEM

Item number	10033331, 10033332
Accessories available separately:	
Seat cushion	10033333 (grey), 10033334 (beige), 10033335 (brown)
Seat cushion covers	10033336 (grey), 10033337 (beige), 10033338 (brown)
Protective cover	10033339

ARTICLE

Numéro d'article	10033331, 10033332
Accessoires disponibles séparément :	
Coussins d'assise	10033333 (gris), 10033334 (beige), 10033335 (marron),
Housses de coussins d'assise	10033336 (gris), 10033337 (beige), 10033338 (marron)
Couverture	10033339

ARTÍCULO











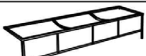

Número de artículo	10033331, 10033332
Accesorios disponibles por separado:	
Cojín del asiento	10033333 (gris), 10033334 (beige), 10033335 (marrón)
Fundas de cojín de asiento	10033336 (gris), 10033337 (beige), 10033338 (marrón)
Funda protectora	10033339





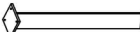







ARTICOLO

Numero articolo	10033331, 10033332
Accessori acquistabili separatamente:	
Cuscino seduta	10033333 (grigio), 10033334 (beige), 10033335 (marrone),
Federe cuscino seduta	10033336 (grigio), 10033337 (beige), 10033338 (marrone)
Copertura protettiva	10033339

LIEFERUMFANG

Scope of delivery | Contenu de la livraison | Volumen de suministro |
Dotazione di fornitura

A		1
B		1
C		1
D		1
E		1
F		1
G		1
H		1
I		4
J		1
K		6
L		6

M		6
N		3
O		77
P	 M6x60	4
Q	 M6x35	17
R	 M6x20	18
S	 M6x30	36
T	 M6x40	2
V		1
w		1
X		1
Y		5
Z		3

ZUSAMMENBAU

Assembly | Ensamblaje | Assemblée | Assemblaggio

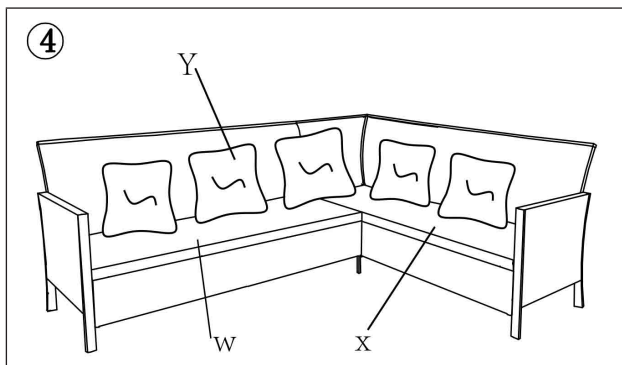
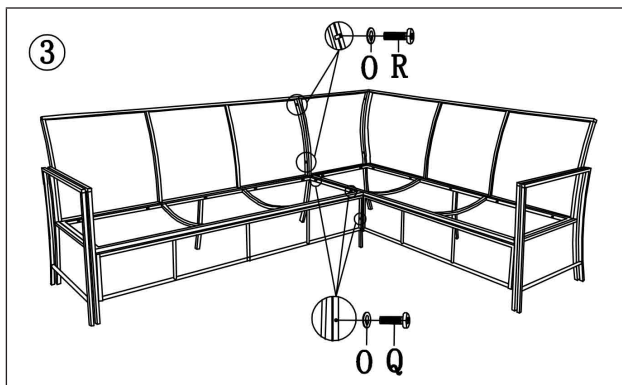
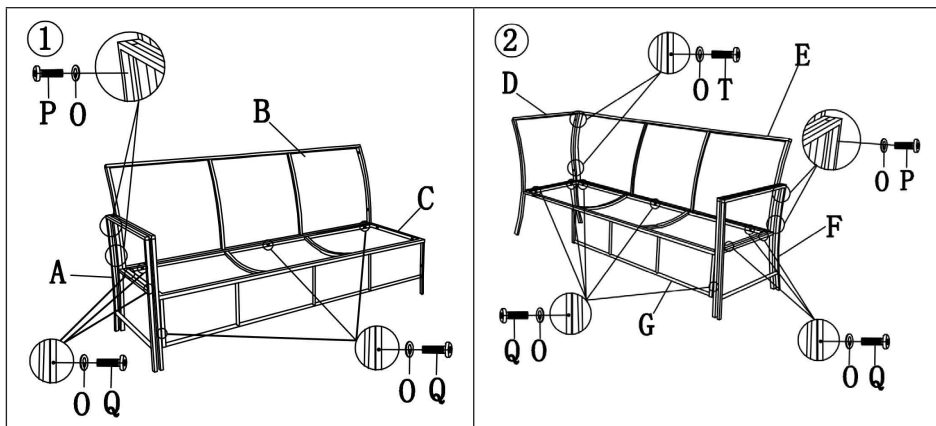

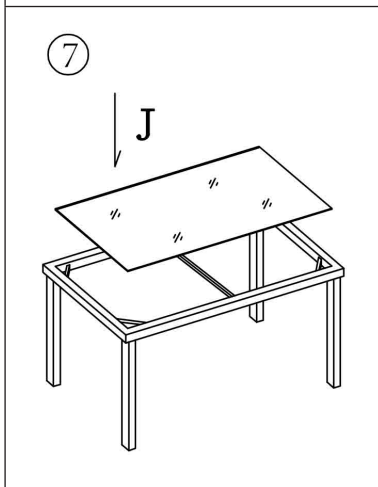
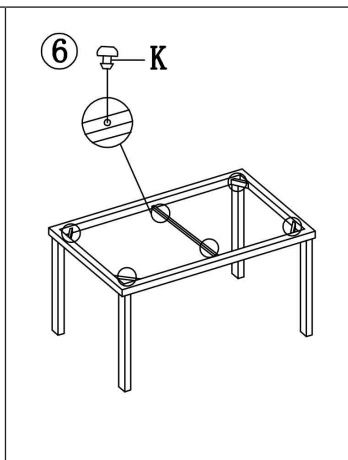
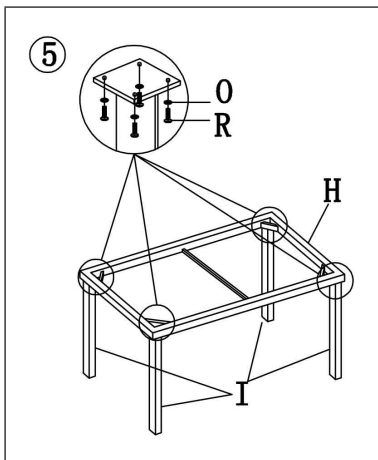

8

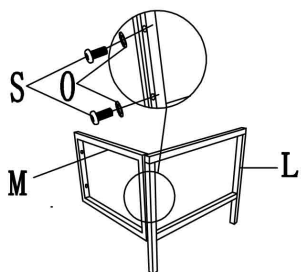

9

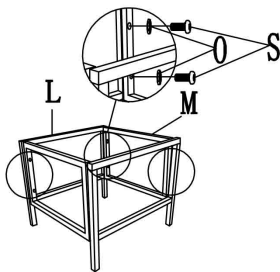

10

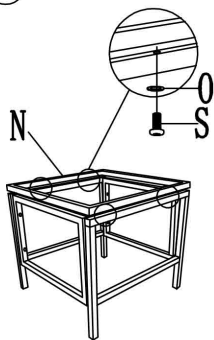

11

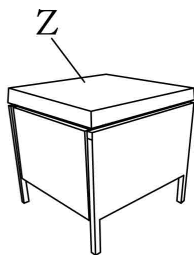

HERSTELLER

Manufacturer | Fabricante | Fabricant | Produttore

Chal-Tec GmbH, Wallstraße 16, 10179 Berlin, Deutschland (Germany).

IMPORTEUR FÜR GROSSBRITANNIEN

Importer for Great Britain | Importador para Gran Bretaña | Importateur pour la Grande Bretagne | Importatore per la Gran Bretagna

Berlin Brands Group UK Limited
PO Box 42
272 Kensington High Street
London, W8 6ND
United Kingdom

