



blumfeldt

Beverlywood Rocking Chair

Sonnenliege

Sunbed

10033453 10033454



Sehr geehrter Kunde,

wir gratulieren Ihnen zum Erwerb Ihres Gerätes. Lesen Sie die folgenden Hinweise sorgfältig durch und befolgen Sie diese, um möglichen Schäden vorzubeugen. Für Schäden, die durch Missachtung der Hinweise und unsachgemäßen Gebrauch entstehen, übernehmen wir keine Haftung. Scannen Sie den folgenden QR-Code, um Zugriff auf die aktuellste Bedienungsanleitung und weitere Informationen rund um das Produkt zu erhalten:



Dear Customer,











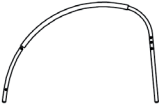

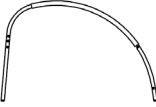
Congratulations on purchasing this equipment. Please read this manual carefully and take care of the following hints to avoid damages. Any failure caused by ignoring the items and cautions mentioned in the instruction manual is not covered by our warranty and any liability. Scan the QR code to get access to the latest user manual and other information about the product:

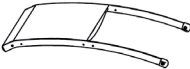

WICHTIGE HINWEISE / IMPORTANT NOTES

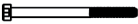
<p>Sicherheit</p> <ul style="list-style-type: none"> • Stecken Sie beim Ausklappen und Zusammenfalten die Hände nicht in bewegliche Teile. • Überprüfen Sie nach dem Aufstellen der Sonnenliege, ob sie stabil steht. 	<p>Safety</p> <ul style="list-style-type: none"> • When unfolding and folding, do not put your hands in moving parts. • After setting up the sunbed, check that it is stable.
<p>Reinigung und Pflege</p> <ul style="list-style-type: none"> • Wischen Sie ie Oberfläche mit einem feuchten Lappen ab. • Verwenden Sie keine Scheuermittel und scharfen Reiniger. 	<p>Cleaning and Care</p> <ul style="list-style-type: none"> • Wipe the urface with a damp cloth. • Do not use scouring agents or sharp cleaners.

EINZELTEILE / PARTS

A-R		1	D		1
A-L		1	E		1
B		1	F		1
C		1	G		1
			H		1
Kleinteile / Small parts					
I		M6X70	2		
J		M6X50	8		
K		M6X45	4		
L					4
M					1

ZUSAMMENBAU / ASSEMBLY

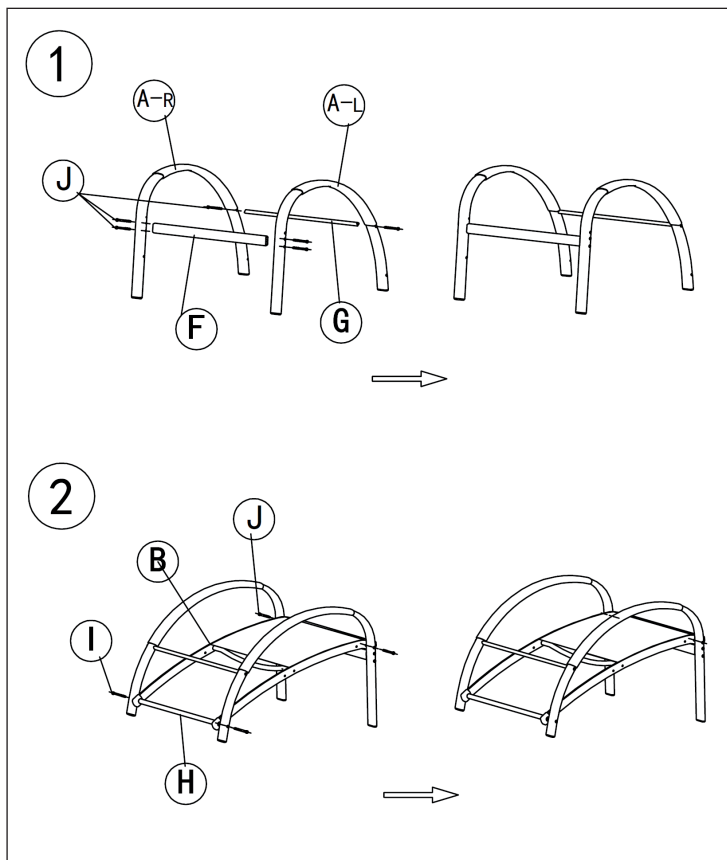

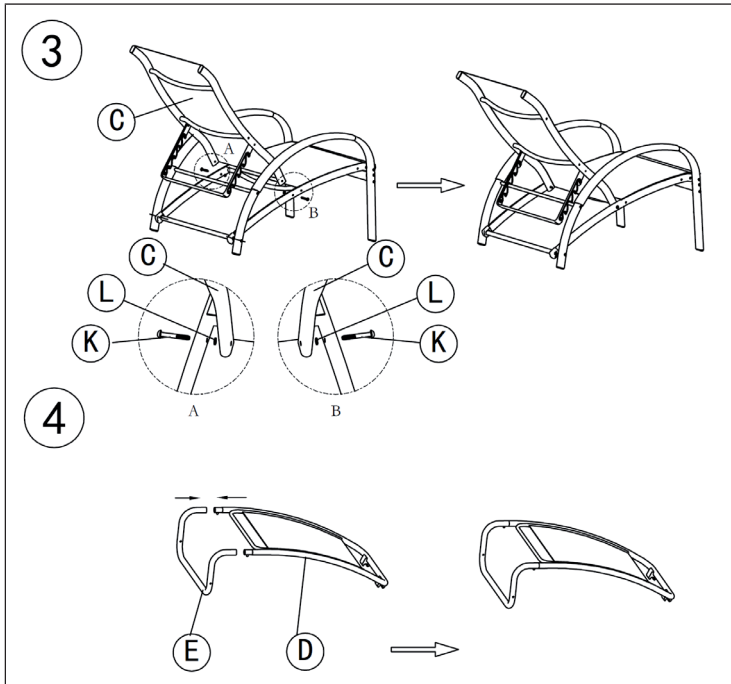

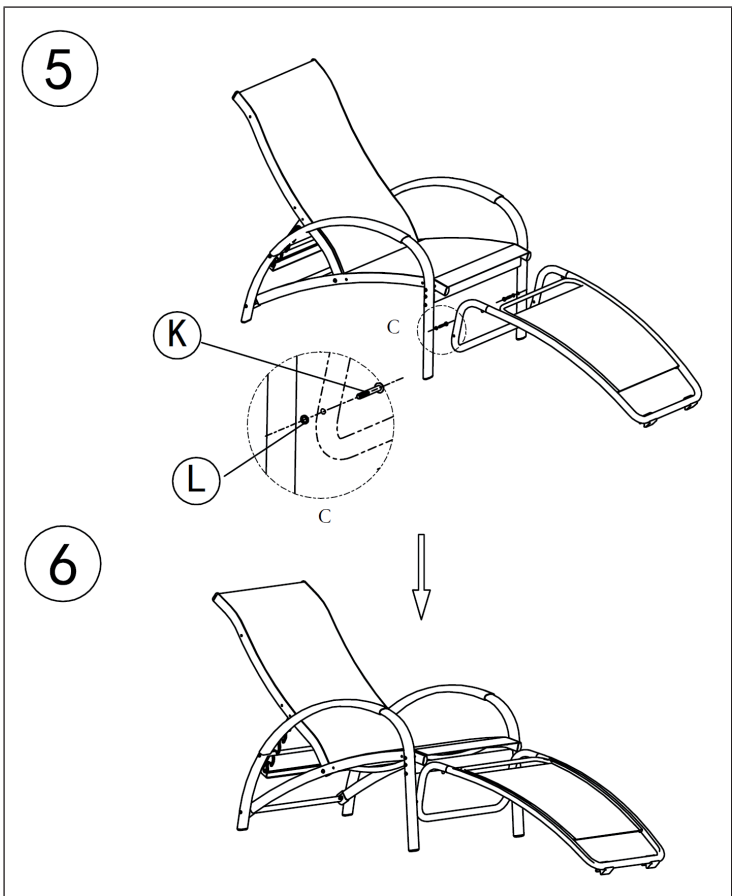

7

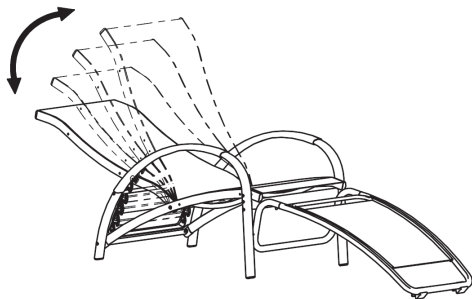

8

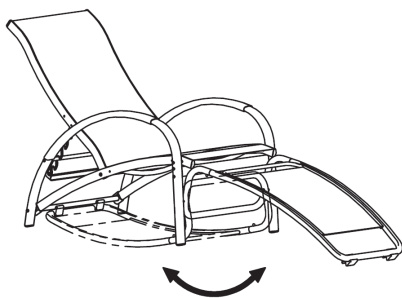

HERSTELLER / PRODUCER

Chal-Tec GmbH, Wallstraße 16, 10179 Berlin, Deutschland (Germany)

