



blumfeldt



Altiplano Cubic

Hochbeet
Raised Bed

10033605

Sehr geehrter Kunde,

wir gratulieren Ihnen zum Erwerb Ihres Produkts. Lesen Sie die folgenden Hinweise sorgfältig durch und befolgen Sie diese, um möglichen Schäden vorzubeugen. Für Schäden, die durch Missachtung der Hinweise und unsachgemäßen Gebrauch entstehen, übernehmen wir keine Haftung. Scannen Sie den folgenden QR-Code, um Zugriff auf die aktuellste Bedienungsanleitung und weitere Informationen rund um das Produkt zu erhalten:

**Dear Customer,**

Congratulations on purchasing this product. Please read this manual carefully and take care of the following hints to avoid damages. Any failure caused by ignoring the items and cautions mentioned in the instruction manual is not covered by our warranty and any liability. Scan the QR code to get access to the latest user manual and other information about the product:



TECHNISCHE DATEN / TECHNICAL DATA

Artikelnummer	Item number	10033605
Maße (in cm)	Dimensions (in cm)	100 x 50 x 100

HERSTELLER / MANUFACTURER

Chal-Tec GmbH, Wallstraße 16, 10179 Berlin, Deutschland (Germany).

IMPORTEUR FÜR GROSSBRITANNIEN

Importer for Great Britain

Chal-Tec UK limited
 Unit 6 Riverside Business Centre
 Brighton Road
 Shoreham-by-Sea
 BN43 6RE
 United Kingdom

LIEFERUMFANG / SCOPE OF DELIVERY

1



**Standbein
(4 Stück)
Support leg
(4 pieces)**

2

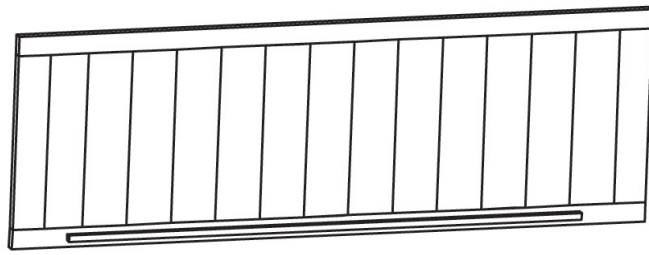

**Vorder- und Rückwand (2 Stück)
Front panel and rear panel (2 pieces)**

3



**Seitenwände (2 Stück)
Side panel (2 pieces)**

7



**Leiste (1 piece)
Pole (1 piece)**



**Schraube 3,5 x
30 mm
(24 Stück)
Screw 3.5 x
30 mm
(24 pieces)**



**Schraube 3,5 x
25 mm
(2 Stück)
Screw 3.5 x 25 mm
(2 pieces)**



**Nagel (16 Stück)
Pin (16 pieces)**

4

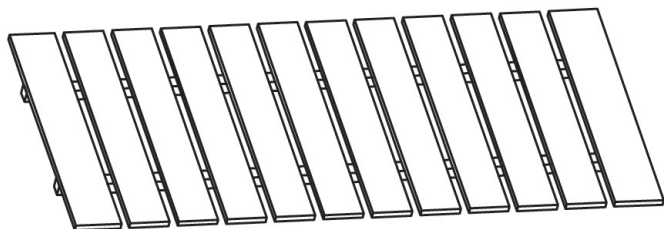

Boden (1 Stück)
Bottom (1 piece)

5

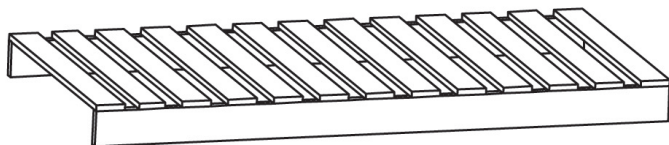

Ablage (1 Stück)
Shelf (1 piece)

6



Innenteil (1 Stück)
Inner tray (1 piece)

MONTAGE / ASSEMBLY

Schritt 1:

Montieren Sie die Vorder- und Rückwand (2) und die Seitenwände (3) am oberen Ende der 4 Standbeine (1) und schrauben Sie diese mit 16 Schrauben (3,5 mm x 30 mm) fest.

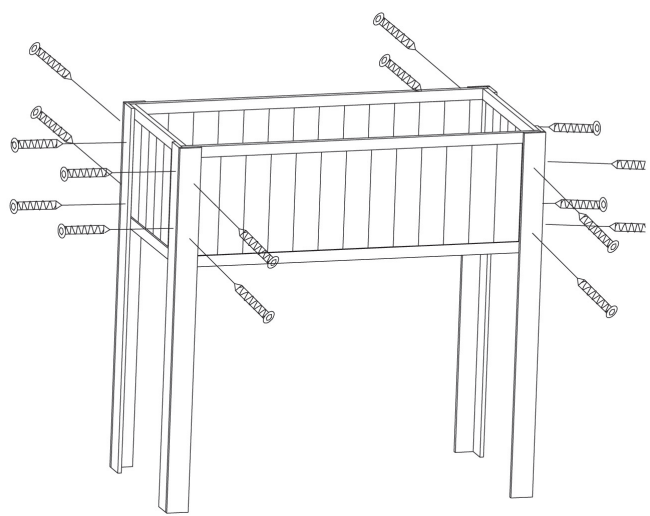

Schrauben 3,5 x 30 mm (16 Stück)
Screws 3.5 x 30 mm (16 pieces)

Step 1:

Mount the front and rear panels (2) and the side panels (3) on the upper end of the 4 support legs (1) and screw them tight with 16 screws (3.5 mm x 30 mm).

Schritt 2:

Montieren Sie die Ablage (5) im unteren Bereich der vier Standbeine (1) und schrauben Sie diese mit 8 Schrauben (3,5 mm x 30 mm) fest.

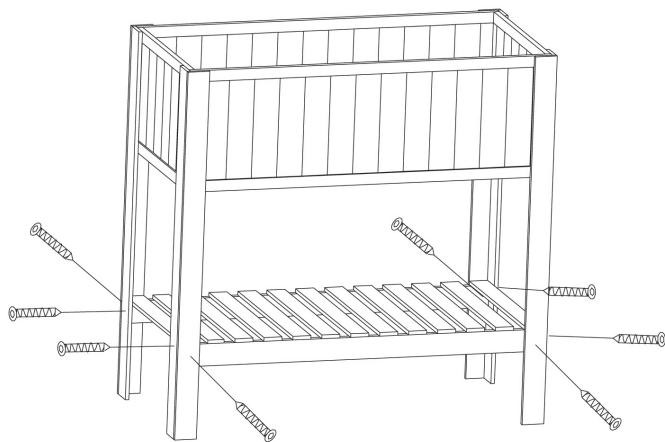

Schrauben 3,5 x 30 mm (8 Stück)
Screws 3.5 x 30 mm (8 pieces)

Step 2:

Mount the shelf (5) in the lower area of the 4 support legs (1) and tighten it with 8 screws (3.5 mm x 30 mm).

Schritt 3:

Legen Sie nun den Boden (4) von oben in das Hochbett hinein.

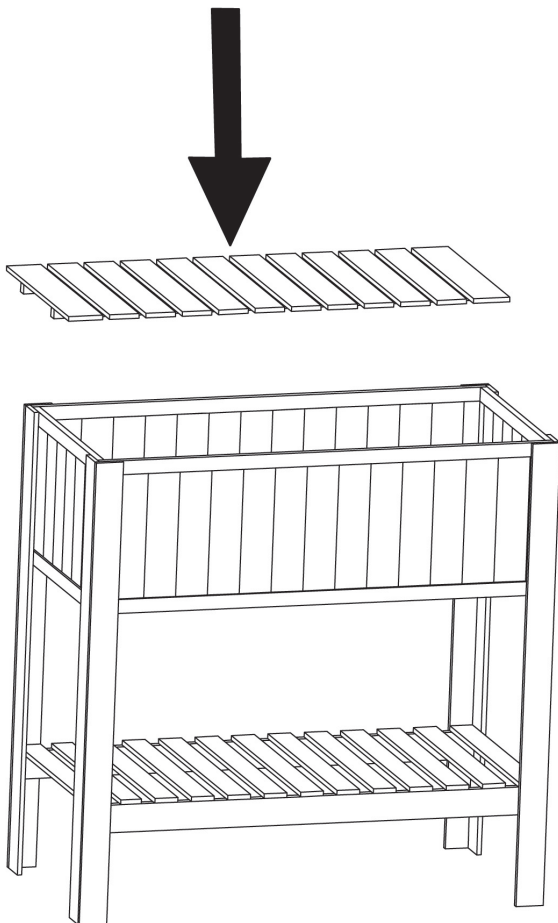

Step 3:

Now place the bottom (4) into the raised bed from above.

Schritt 4:

Befestigen Sie den Boden (4) mit der Leiste (7) von unten mit 2 Schrauben (3,5 mm x 25 mm) am Hochbett.

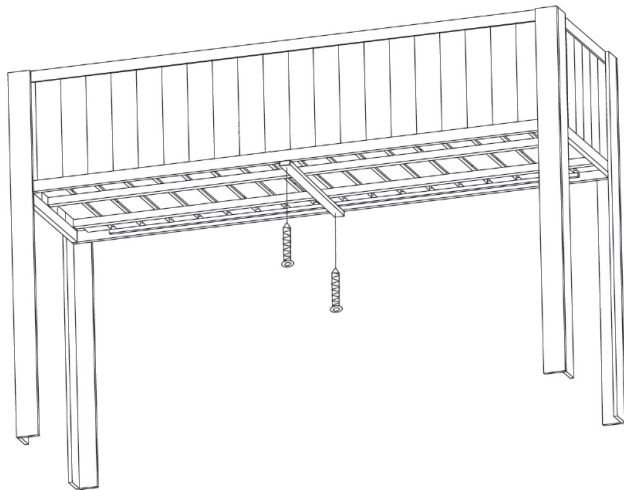

Schrauben 3,5 x 25 mm (2 Stück)
Screws 3.5 x 25 mm (2 pieces)

Step 4:

Fix the bottom (4) with the pole (7) to the raised bed from below with 2 screws (3.5 mm x 25 mm).

Schritt 5:

Befestigen Sie das Innenteil (6) mit 16 Nägeln im Hochbett.

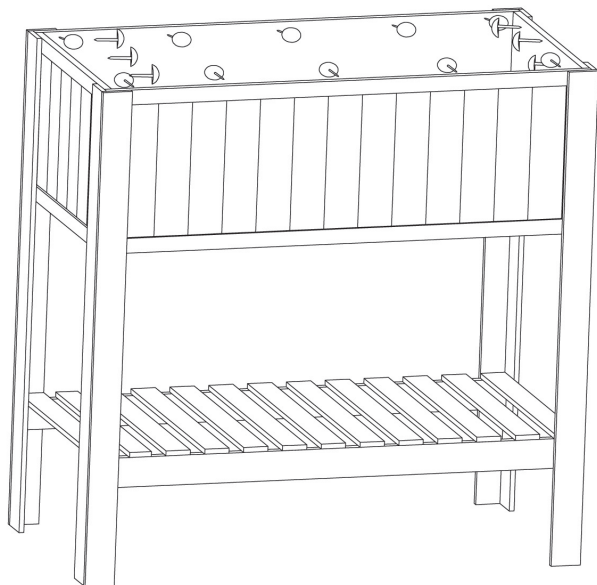

Step 5:

Fix the inner tray (6) with 16 pins in the raised bed.

Ihr Hochbett ist nun fertig montiert und einsatzbereit.
Your raised bed is now fully assembled and ready for use.

