

BESOA

10034021 10034023

Black Onyx I & II

Tisch | Table

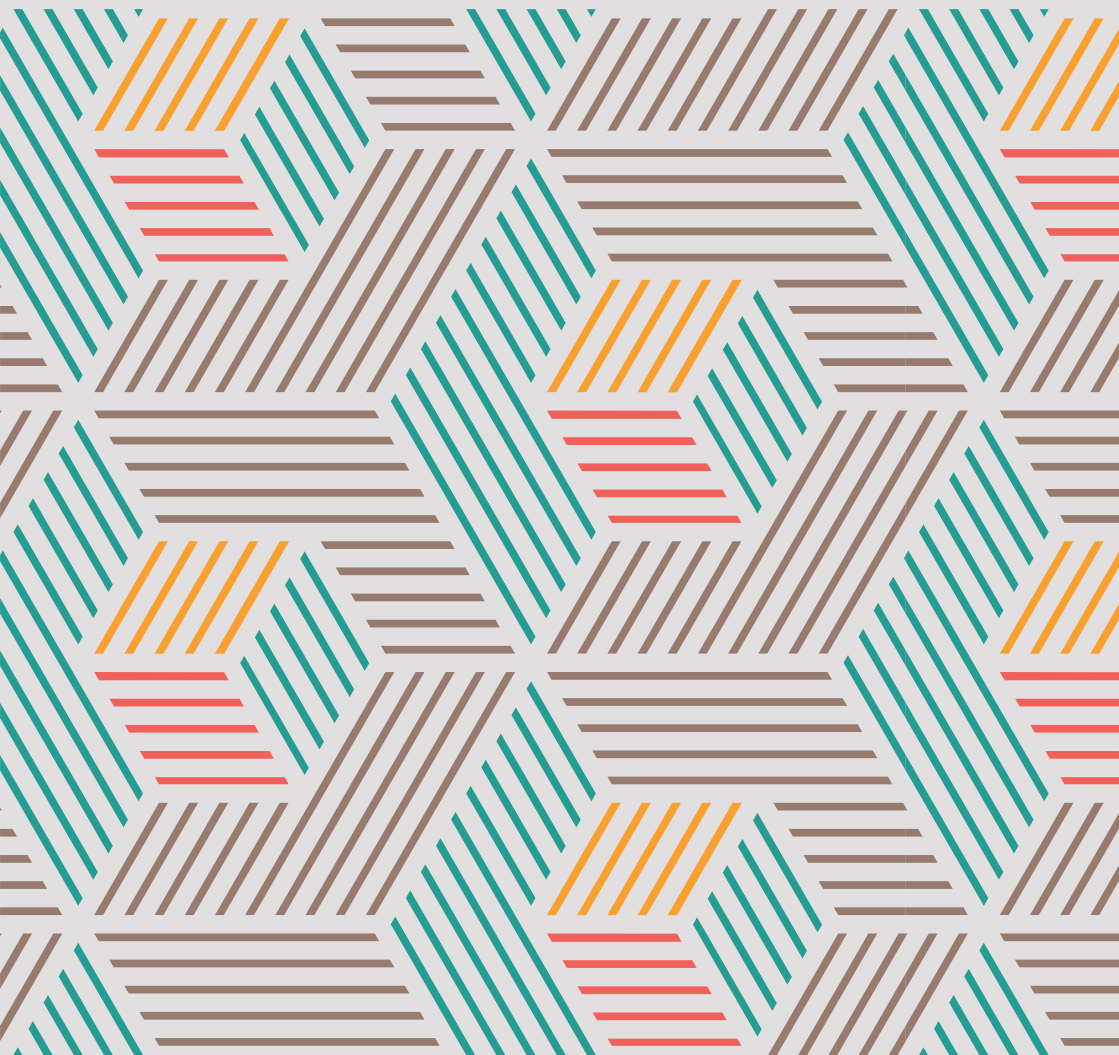

Sehr geehrter Kunde,

wir gratulieren Ihnen zum Erwerb Ihres Gerätes. Lesen Sie die folgenden Hinweise sorgfältig durch und befolgen Sie diese, um möglichen Schäden vorzubeugen. Für Schäden, die durch Missachtung der Hinweise und unsachgemäßen Gebrauch entstehen, übernehmen wir keine Haftung. Scannen Sie den folgenden QR-Code, um Zugriff auf die aktuellste Bedienungsanleitung und weitere Informationen rund um das Produkt zu erhalten:

**Dear Customer,**

Congratulations on purchasing this equipment. Please read this manual carefully and take care of the following hints to avoid damages. Any failure caused by ignoring the items and cautions mentioned in the instruction manual is not covered by our warranty and any liability. Scan the QR code to get access to the latest user manual and other information about the product:



HERSTELLER

Manufacturer

Chal-Tec GmbH, Wallstraße 16, 10179 Berlin, Deutschland (Germany).

IMPORTEUR FÜR GROSSBRITANNIEN

Importer for Great Britain

Chal-Tec UK limited
Unit 6 Riverside Business Centre
Brighton Road
Shoreham-by-Sea
BN43 6RE
United Kingdom





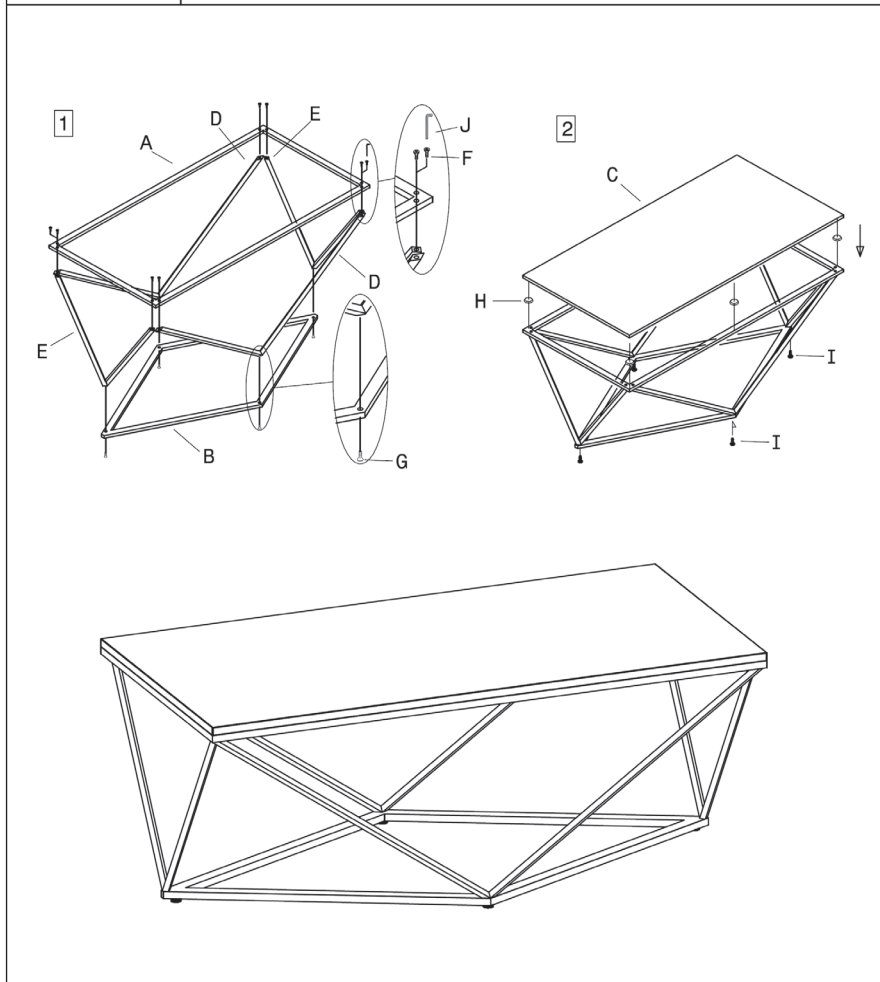

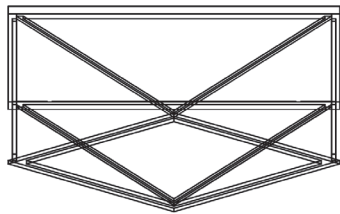
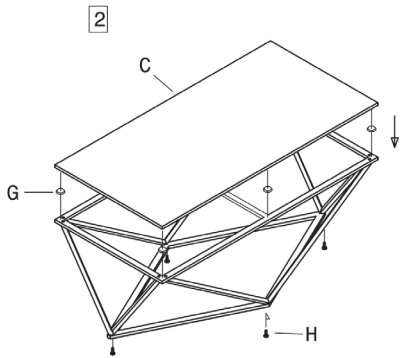
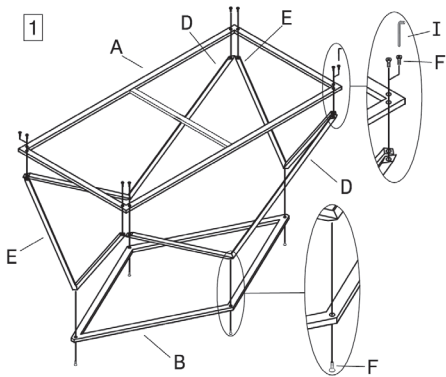

ZUSAMMENBAU | ASSEMBLY

Nr. (No)	A	B	C	D	E	F	G	H	I	J
Typ(e)						M6X20	M6X25			
Abb. (Pic)										
Stk. (Pc)	1	1	1	2	2	8	4	6	4	1
Größe (Dimension)	Breite (W): 110 cm / Tiefe (D): 55 cm / Höhe (H): 44 cm									









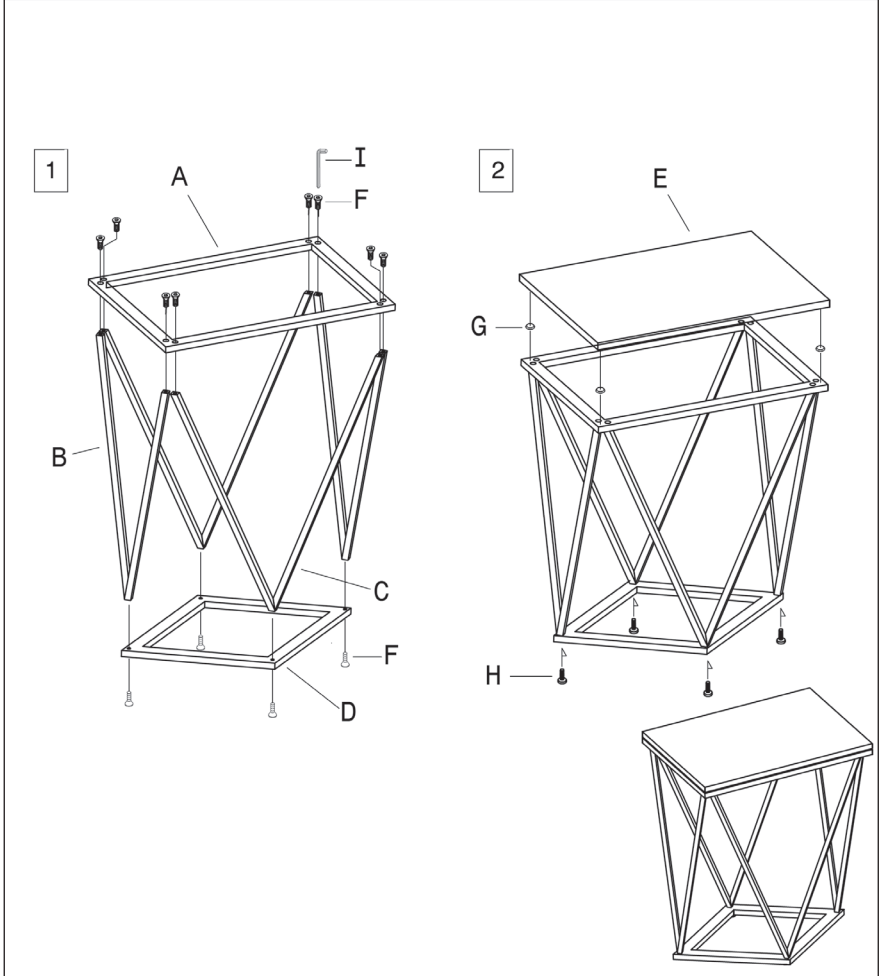

Nr. (No)	A	B	C	D	E	F	G	H	I
Typ(e)						M6X20			
Abb. (Pic)									
Stk. (Pc)	1	1	1	2	2	12	6	4	1
Größe (Dimension)	Breite (W): 110 cm / Tiefe (D): 55 cm / Höhe (H): 44 cm								



Nr. (No)	A	B	C	D	E	F	G	H	I	
Typ(e)						M6*25				
Abb. (Pic)										
Stk. (Pc)	1	2	2	1	1	12	4	4	1	
Größe (Dimension)	Breite (W): 50 cm / Tiefe (D): 35 cm / Höhe (H): 55 cm									



Nr. (No)	A	B	C	D	E	F	G	H	I	
Typ(e)						M6*25				
Abb. (Pic)										
Stk. (Pc)	1	2	2	1	1	12	4	4	1	
Größe (Dimension)	Breite (W): 50 cm / Tiefe (D): 35 cm / Höhe (H): 55 cm									

