



blumfeldt

## Nova Grow

Gartenbeet

Garden Bed

Lecho de jardín

Lit de jardin

Letto da giardino

10034744 10034745 10034746

10034747 10034748 10034752





**Sehr geehrter Kunde,**

wir gratulieren Ihnen zum Erwerb Ihres Gerätes. Lesen Sie die folgenden Hinweise sorgfältig durch und befolgen Sie diese, um möglichen Schäden vorzubeugen. Für Schäden, die durch Missachtung der Hinweise und unsachgemäßen Gebrauch entstehen, übernehmen wir keine Haftung. Scannen Sie den folgenden QR-Code, um Zugriff auf die aktuellste Bedienungsanleitung und weitere Informationen rund um das Produkt zu erhalten:

**Dear Customer,**

Congratulations on purchasing this device. Please read the following instructions carefully and follow them to prevent possible damages. We assume no liability for damage caused by disregard of the instructions and improper use. Scan the QR code to get access to the latest user manual and more product information.

**Estimado cliente,**

Le felicitamos por la adquisición de este producto. Lea atentamente las siguientes instrucciones y sígalas para evitar posibles daños. No asumimos ninguna responsabilidad por los daños causados por el incumplimiento de las instrucciones y el uso inadecuado. Escanee el siguiente código QR para obtener acceso a la última guía del usuario y más información sobre el producto.

**Chère cliente, cher client,**

Toutes nos félicitations pour l'acquisition de ce nouvel appareil. Veuillez lire attentivement et respecter les instructions de ce mode d'emploi afin d'éviter d'éventuels dommages. Nous ne saurions être tenus pour responsables des dommages dus au non-respect des consignes et à la mauvaise utilisation de l'appareil. Scannez le QR-Code pour obtenir la dernière version du mode d'emploi et des informations supplémentaires concernant le produit.







**Gentile cliente,**

La ringraziamo per aver acquistato il dispositivo. La preghiamo di leggere attentamente le seguenti istruzioni per l'uso e di seguirle per evitare possibili danni. Non ci assumiamo alcuna responsabilità per danni scaturiti da una mancata osservazione delle avvertenze di sicurezza e da un uso improprio del dispositivo. Scansionare il codice QR seguente, per accedere al manuale d'uso più attuale e per ricevere informazioni sul prodotto.



# LIEFERUMFANG

Scope of delivery | Volumen de suministro | Contenu de la livraison |  
Dotazione di fornitura

Ax4 	C1x6 	C2x6 	Dx40 
Ex4 	F1x4 	F2x4 	

# ZUSAMMENBAU

Assembly | ensamblaje | assemblée | assemblaggio

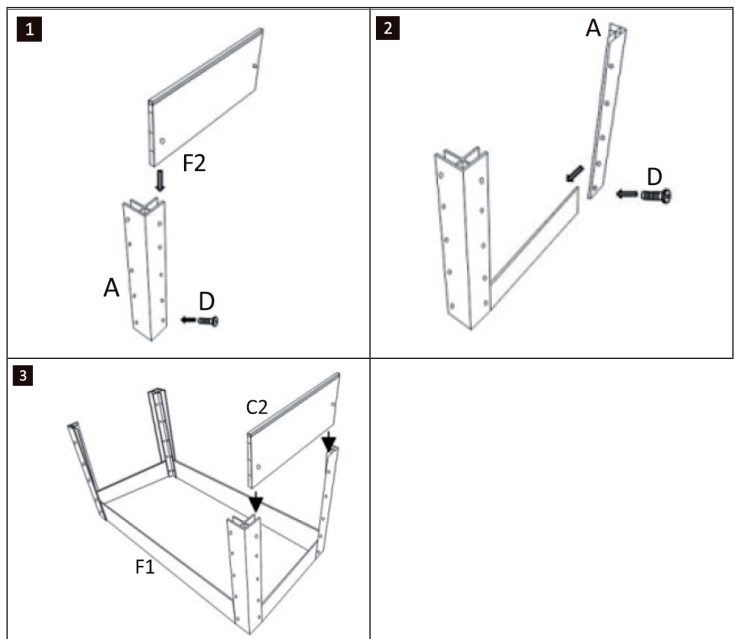

4

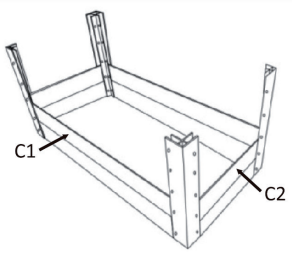

5

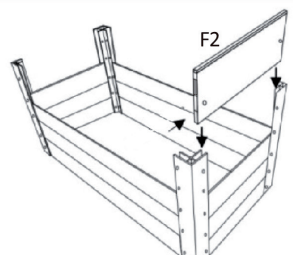

6

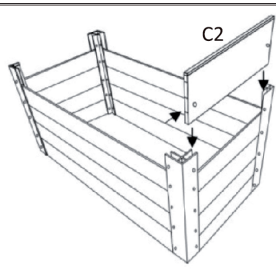

7

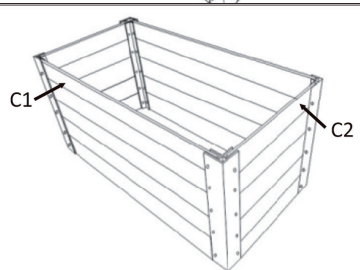

8

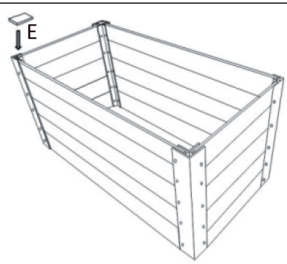

9

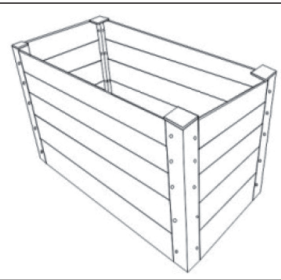

---

## TECHNISCHE DATEN

---

Technical data | Datos técnicos | Fiche technique | Dati tecnici

<b>Artikelnummer</b> Item number Número de artículo Numéro d'article Numero di articolo	<b>Abmessungen</b> Dimensions Dimensiones Dimensions Dimensioni
10034744	100x50x91 cm
10034745	100x100x91 cm
10034746	150x50x91 cm
10034747	150x100x91 cm
10034748	195x50x91 cm
10034752	195x100x91 cm

---

## HERSTELLER

---

Chal-Tec GmbH, Wallstraße 16, 10179 Berlin, Deutschland.

**Producer**

Chal-Tec GmbH, Wallstraße 16, 10179 Berlin, Germany.

**Fabricante**

Chal-Tec GmbH, Wallstraße 16, 10179 Berlin, Alemania.

**Fabricant**

Chal-Tec GmbH, Wallstraße 16, 10179 Berlin, Allemagne.

**Produttore**

Chal-Tec GmbH, Wallstraße 16, 10179 Berlin, Germania.



