



blumfeldt

## Lucca

Sonnenliege

Sunbed

Hamaca

Bain de soleil

Sedia a sdraio

10035443





**Sehr geehrter Kunde,**

wir gratulieren Ihnen zum Erwerb Ihres Gerätes. Lesen Sie die folgenden Hinweise sorgfältig durch und befolgen Sie diese, um möglichen Schäden vorzubeugen. Für Schäden, die durch Missachtung der Hinweise und unsachgemäßen Gebrauch entstehen, übernehmen wir keine Haftung. Scannen Sie den folgenden QR-Code, um Zugriff auf die aktuellste Bedienungsanleitung und weitere Informationen rund um das Produkt zu erhalten:

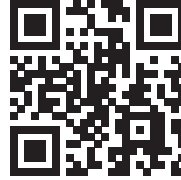

---

**INHALTSVERZEICHNIS**

---

Sicherheitshinweise 4  
Hinweise zum Zusammenbau 4  
Einzelteile 5  
Zusammenbau 6  
Verwendungsmöglichkeiten 9

**English 11**  
**Español 19**  
**Français 27**  
**Italiano 35**

---

**HERSTELLER**

---

Chal-Tec GmbH, Wallstraße 16, 10179 Berlin, Deutschland.

---

## SICHERHEITSHINWEISE

---

Die Sonnenliege und die zugehörigen Teile wurden aus Aluminium in Kombination mit textilem Material hergestellt. Gartenmöbel sind Umwelteinflüssen ausgesetzt, wie großen Temperaturschwankungen, Feuchtigkeit und intensiver Sonneneinstrahlung. Damit Sie länger Freude an Ihrer Sonnenliege haben, sollten Sie die folgenden Hinweise beachten:

- Vermeiden Sie längeren Kontakt mit Feuchtigkeit und stehendem Wasser. Nehmen Sie Ihre Möbel bei Regen ins Haus oder decken Sie sie mit einer Schutzhülle ab. Bei kurzen Regenschauern sollten die Möbel nach dem Regen leicht gekippt und die Feuchtigkeit abgewischt werden. Bei längerem Abdecken ist für eine ausreichende Luftzirkulation zu sorgen.
- Wir empfehlen Ihnen die Kissenbezüge bei der Reinigung auf dem Kissen zu belassen, anstatt sie zu entfernen. Reinigen Sie die äußere Kissenhülle mit sauberem Wasser und einer weichen Bürste. Entfernen Sie hartnäckige Verschmutzungen mit etwas Seifenlauge und wischen Sie dann mit einem sauberen Lappen und klarem Wasser nach. Lassen Sie die Kissen nach der Reinigung oder vor der Lagerung vollständig an der Luft trocknen. Geben Sie die Stoffe niemals in die Waschmaschine oder den Trockner.
- Vermeiden Sie den Kontakt mit Sonnenschutzmitteln oder Bräunungsmitteln.
- Die Schrauben sind aus rostfreiem Stahl gefertigt, um eine höhere Haltbarkeit zu erzielen. Ziehen Sie die Schrauben nicht zu stark an.
- Der Rahmen ist pulverbeschichtet. Durch den Gebrauch und Transport können Lackschäden entstehen. Bessern Sie diese rechtzeitig mit einem Tupfer Farbe aus, um Rost zu verhindern.
- Schützen Sie die Sonnenliege bei Nichtgebrauch vor übermäßiger Sonneneinstrahlung, da es sonst zum Ausbleichen der Farbe kommen kann.
- Lagern Sie die Sonnenliege im Winter an einem kühlen, trockenen und frostfreien Ort lagern. Die Sonnenliege ist nicht winterfest.
- Bitte benutzen Sie einzelnen Teile nur zum Sitzen oder Liegen. Sie sind nicht als Ersatz für eine Leiter oder als Turngerät für Kinder geeignet.
- Die Sonnenliege und alle zugehörigen Teile sind nur für den privaten Gebrauch bestimmt.

**Hinweis:** Stühle und Liegen sind bis 100 kg, zweisitzige Bänke bis 160 kg und dreisitzige Bänke bis 240 kg belastbar.













---

## HINWEISE ZUM ZUSAMMENBAU

---

- Bauen Sie die Einzelteile auf einen Teppich zusammen, damit sie beim Zusammenbau nicht beschädigt werden.
- Ziehen Sie die Schrauben erst an, wenn sich alle Schrauben des Bauteils in der richtigen Position befinden.

## EINZELTEILE

Einzelteile					
A		1	H		2
B		1	I		4
C		1	J		2
D		1	K		2
E		2	L		1
F		12	M		1
G		12			

# ZUSAMMENBAU

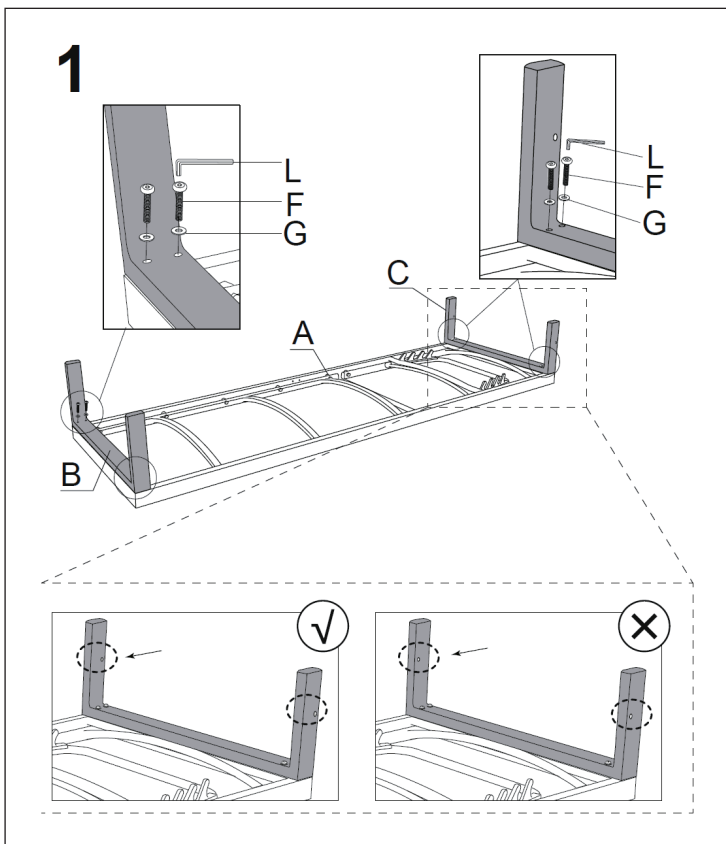

# 2

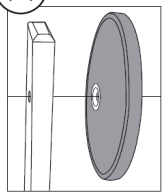
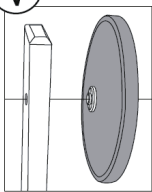
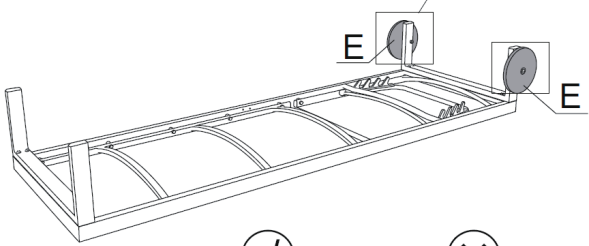
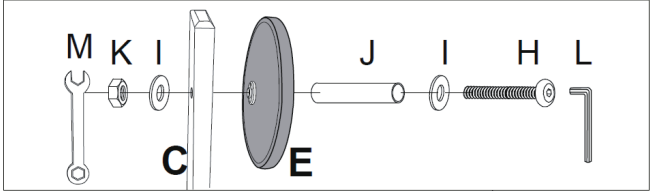

# 3

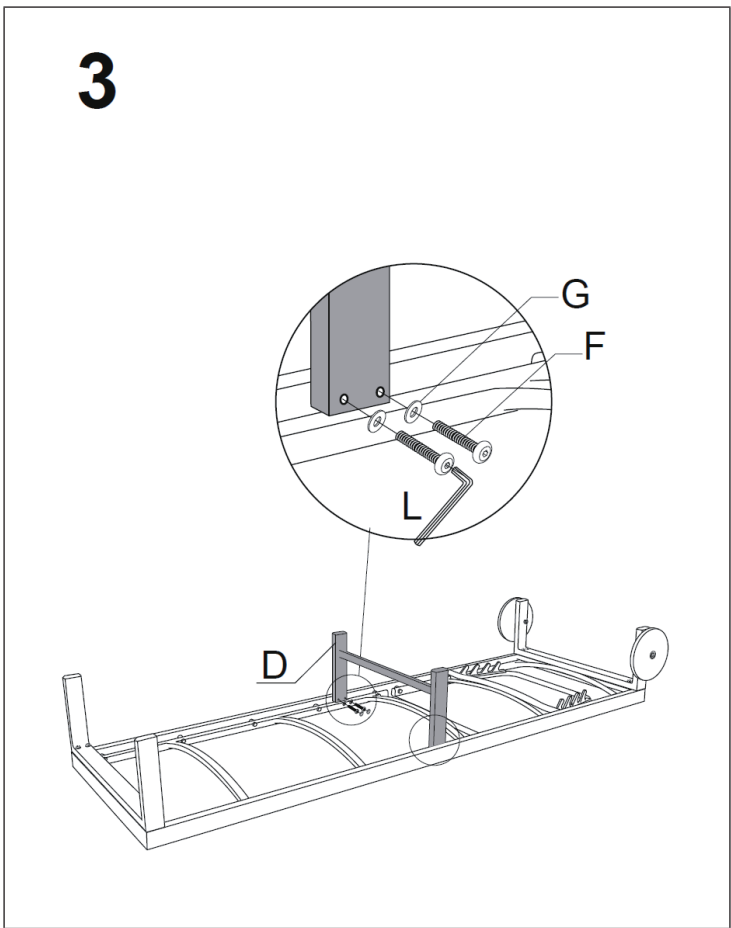



## VERWENDUNGSMÖGLICHKEITEN

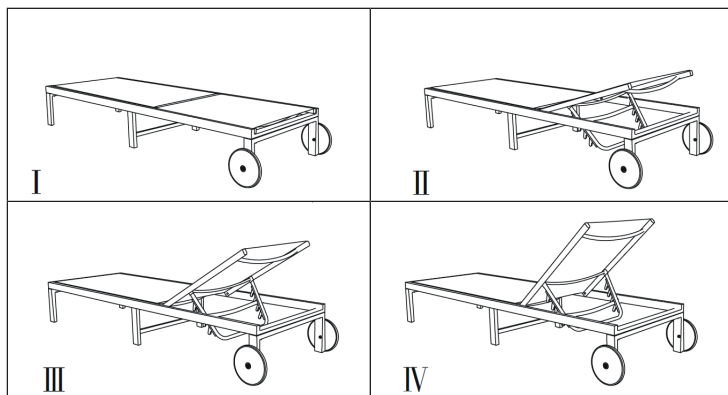

**Verletzungsgefahr! Verwenden Sie die Sonnenliege nicht wie folgt:**

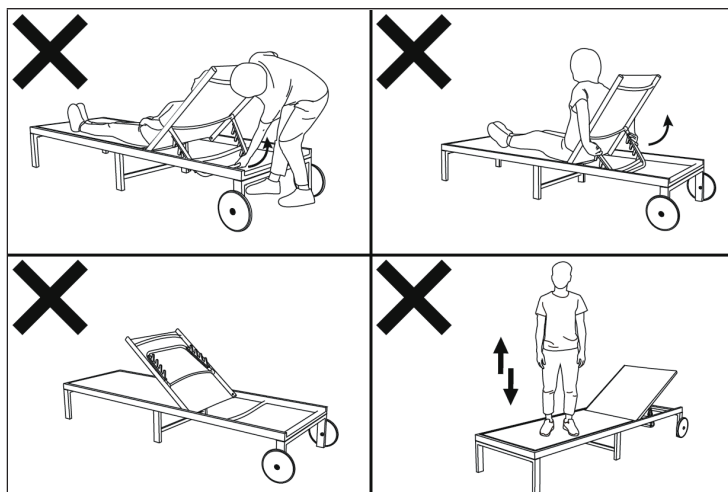

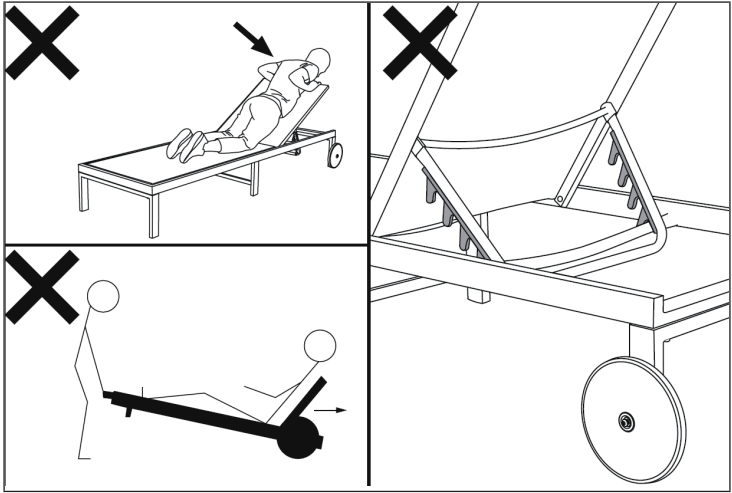

**Dear Customer,**

Congratulations on purchasing this device. Please read the following instructions carefully and follow them to prevent possible damages. We assume no liability for damage caused by disregard of the instructions and improper use. Scan the QR code to get access to the latest user manual and more product information.

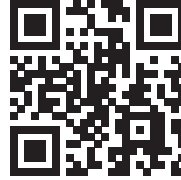

---

**CONTENT**

---

Safety Instructions 12  
Hints for assembly 12  
Overview and Individual Parts 13  
Assembly 14  
Possible Uses 17

---

**PRODUCER**

---

Chal-Tec GmbH, Wallstraße 16, 10179 Berlin, Germany.

---

## SAFETY INSTRUCTIONS

---

The sunbed and its parts were made of aluminium in combination with textile material. Garden furniture is exposed to environmental influences such as large temperature fluctuations, humidity and intensive sunlight. In order to enjoy your sunbed longer, you should follow the following instructions:

- Avoid prolonged contact with moisture and standing water. Take your furniture inside in the rain or cover it with a protective cover. In case of short rain showers, tilt the furniture slightly after the rain and wipe off the moisture. If you cover the furniture for a longer period of time, make sure that there is sufficient air circulation.
- We recommend leaving the cushion covers on the cushion during cleaning instead of removing them. Clean the outer cushion cover with clean water and a soft brush. Remove stubborn dirt with a little soapy water and then wipe with a clean cloth and clear water. Allow the pillows to air dry completely after cleaning or before storage. Never put them in the washing machine or dryer.
- Avoid contact with sunscreen or tanning products.
- The screws are made of stainless steel for greater durability. Do not overtighten the screws.
- The frame is powder-coated. Use and transport can cause damage to the coating. Repair this immediately with a dab of paint to prevent rust.
- When not in use, protect the sunbed from excessive sunlight, otherwise the colour may fade.
- Store the sunbed in winter in a cool, dry and frost-free place. The sunbed is not winterproof.
- Please use individual parts only for sitting or lying. They are not suitable as a replacement for a ladder or as gymnastics equipment for children.
- The sunbed and all related parts are for private use only.

**Note:** Chairs and sunbeds can be loaded up to 100 kg, two-seater benches up to 160 kg and three-seater benches up to 240 kg.













---

## HINTS FOR ASSEMBLY

---

- Put the parts together on a carpet so that they are not damaged during assembly.
- Do not tighten the screws until all screws of the component are in the correct position.

## OVERVIEW AND INDIVIDUAL PARTS

Individual parts					
A		1	H		2
B		1	I		4
C		1	J		2
D		1	K		2
E		2	L		1
F		12	M		1
G		12			

# ASSEMBLY

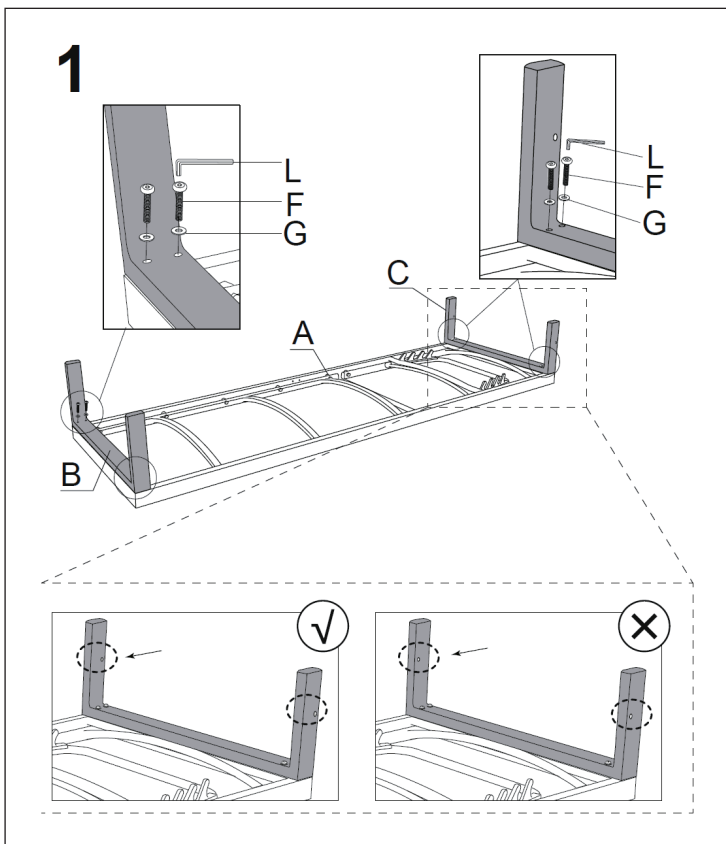

# 2

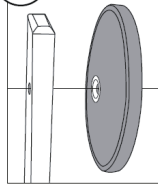
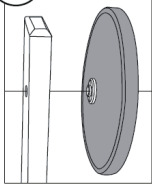
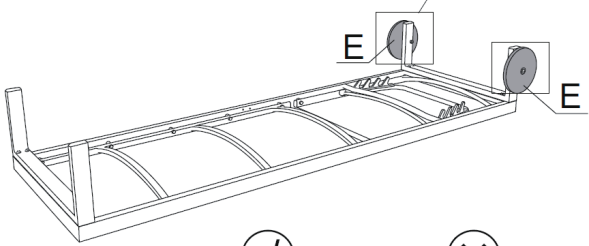
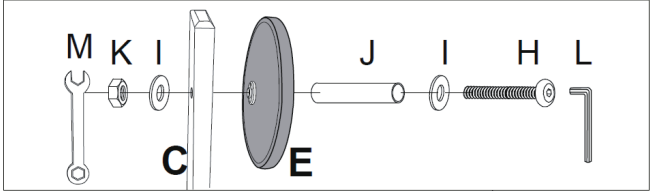

# 3

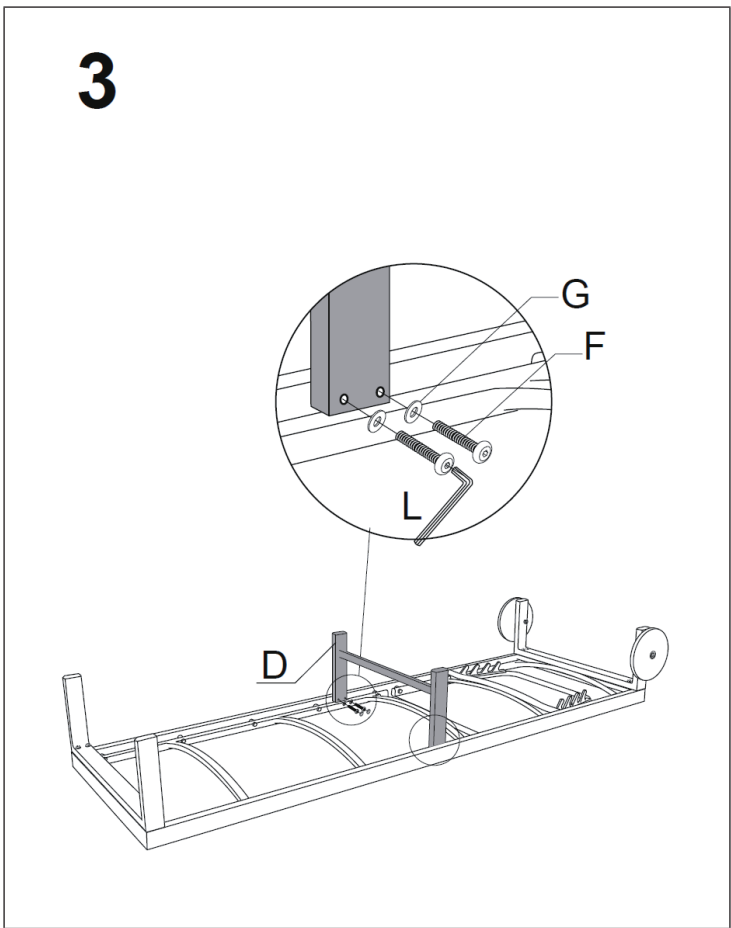

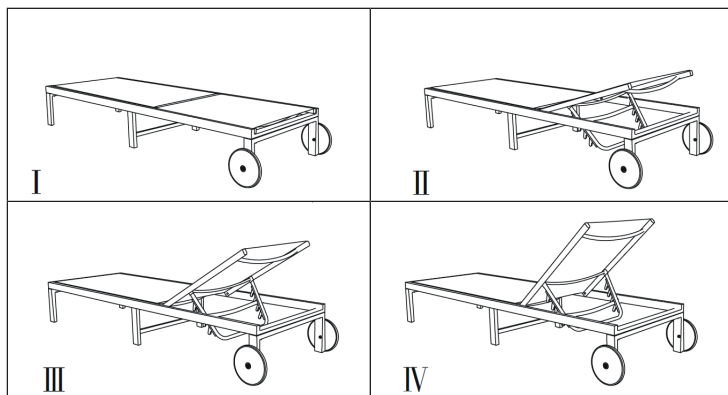

**POSSIBLE USES**

**Danger of injury! Do not use the sunbed as follows:**

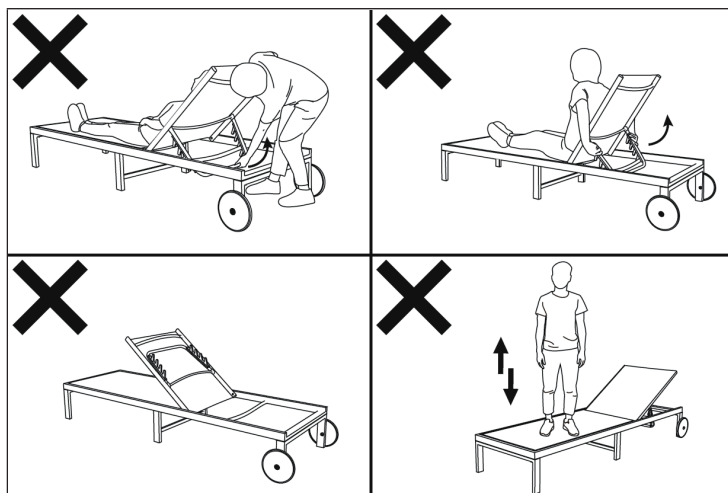

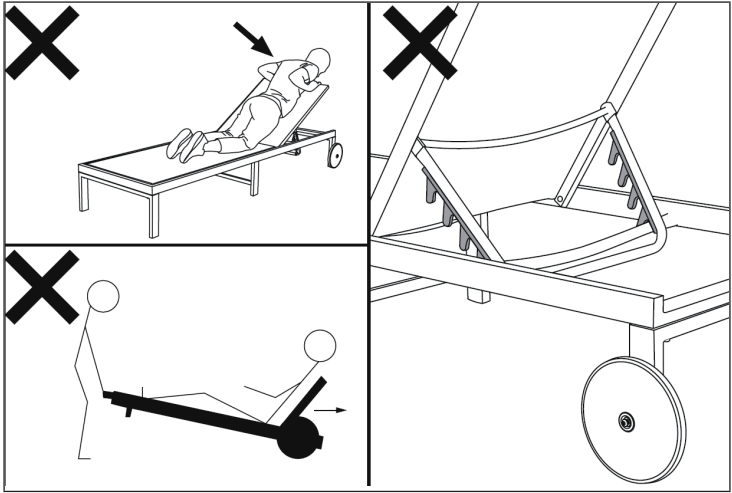

**Estimado cliente,**

Le felicitamos por la adquisición de este producto. Lea atentamente las siguientes instrucciones y sígalas para evitar posibles daños. No asumimos ninguna responsabilidad por los daños causados por el incumplimiento de las instrucciones y el uso inadecuado. Escanee el siguiente código QR para obtener acceso a la última guía del usuario y más información sobre el producto.

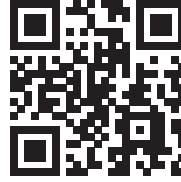

---

**ÍNDICE**

---

Indicaciones de seguridad 20  
Indicaciones sobre el montaje 20  
Descripción y lista de los componentes 21  
Montaje 22  
Posibles usos 25

---

**FABRICANTE**

---

Chal-Tec GmbH, Wallstraße 16, 10179 Berlín, Alemania.

---

## INDICACIONES DE SEGURIDAD

---

La hamaca y sus accesorios se han construido en aluminio y material textil. Los muebles para jardín se exponen a las condiciones climáticas, como grandes oscilaciones de temperatura, humedad y exposición permanente al sol. Para poder disfrutar de su hamaca durante mucho tiempo, tenga en cuenta las siguientes indicaciones:

- Evite un contacto prolongado con la humedad y el agua. Introduzca los muebles en casa o cúbralos con una funda protectora en caso de lluvia. En caso de chubascos débiles, los muebles deben inclinarse ligeramente para drenar la humedad. Si se mantienen tapados durante mucho tiempo, es necesario garantizar suficiente circulación del aire.
- Recomendamos dejar las fundas de los cojines cuando los limpie en lugar de retirarlas. Lave la funda exterior de los cojines con agua limpia y un cepillo de cerdas suaves. Retire la suciedad incrustada con agua y jabón y luego pase un paño limpio y agua para aclarar. Deje que los cojines se sequen al aire antes de guardarlos. Nunca introduzca los tejidos en la lavadora o secadora.
- Evite el contacto con aceite bronceador y otros productos similares.
- Los tornillos están fabricados en acero inoxidable para lograr una elevada durabilidad. No apriete demasiado los tornillos.
- La estructura está recubierta en polvo. Con el uso y el transporte, pueden producirse daños en el lacado. Para evitar el óxido, cubra inmediatamente el punto dañado con un brochazo de pintura.
- Proteja la hamaca de la radiación excesiva del sol cuando no la utilice, pues podría decolorarse.
- Guarde la hamaca en un lugar fresco, seco y protegido de la escarcha durante el invierno. La hamaca no resiste el clima de invierno.
- Utilice el producto para sentarse o tumbarse. No debe emplearse como sustituto de una escalera o como cama elástica para niños.
- La hamaca y todos sus componentes están indicados para uso particular.

**Nota:** La silla y la hamaca soportan una capacidad de carga de hasta 100 kg, el banco de dos plazas, de 160 kg y el banco de tres plazas, de hasta 240 kg.













---

## INDICACIONES SOBRE EL MONTAJE

---

- Monte cada una de las piezas sobre una alfombra para evitar que se dañen durante el proceso.
- Apriete los tornillos solo cuando todos ellos se encuentren en la posición correcta.

## DESCRIPCIÓN Y LISTA DE LOS COMPONENTES

Componentes					
A		1	H		2
B		1	I		4
C		1	J		2
D		1	K		2
E		2	L		1
F		12	M		1
G		12			

# MONTAJE

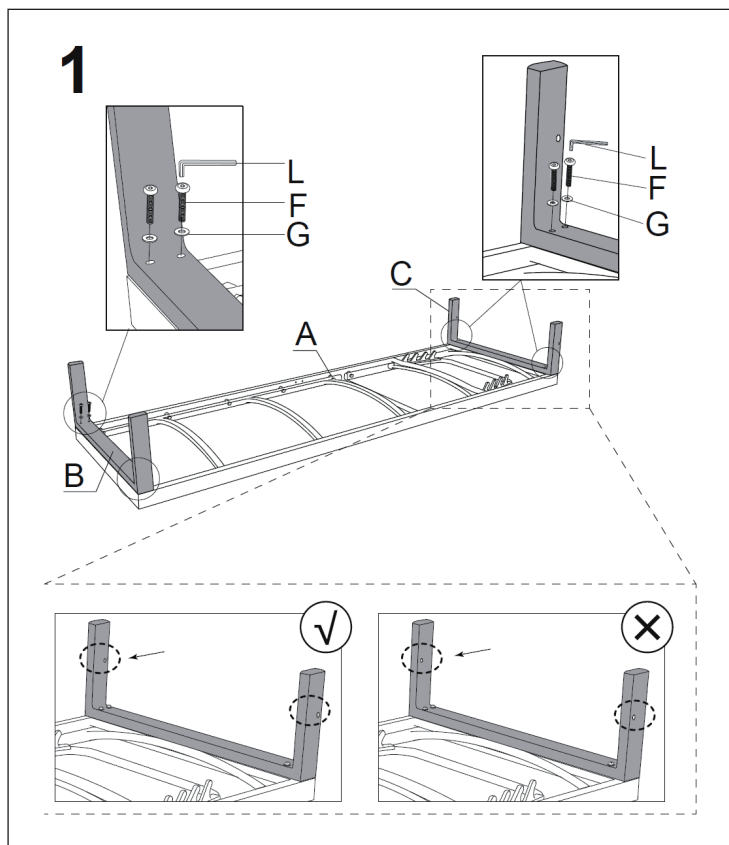

# 2

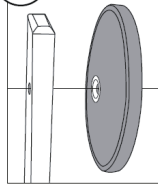
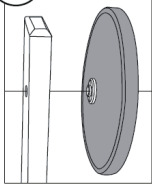
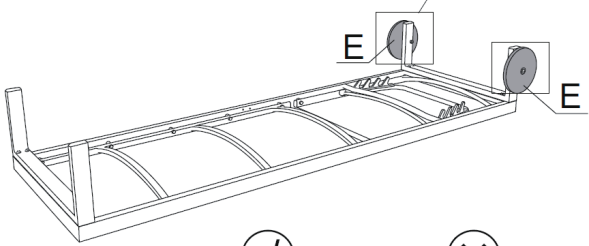
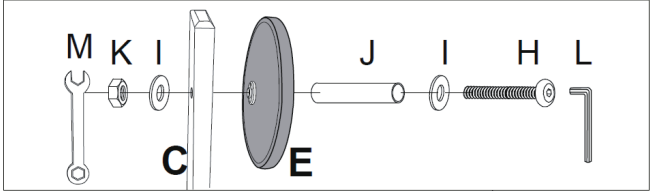

# 3

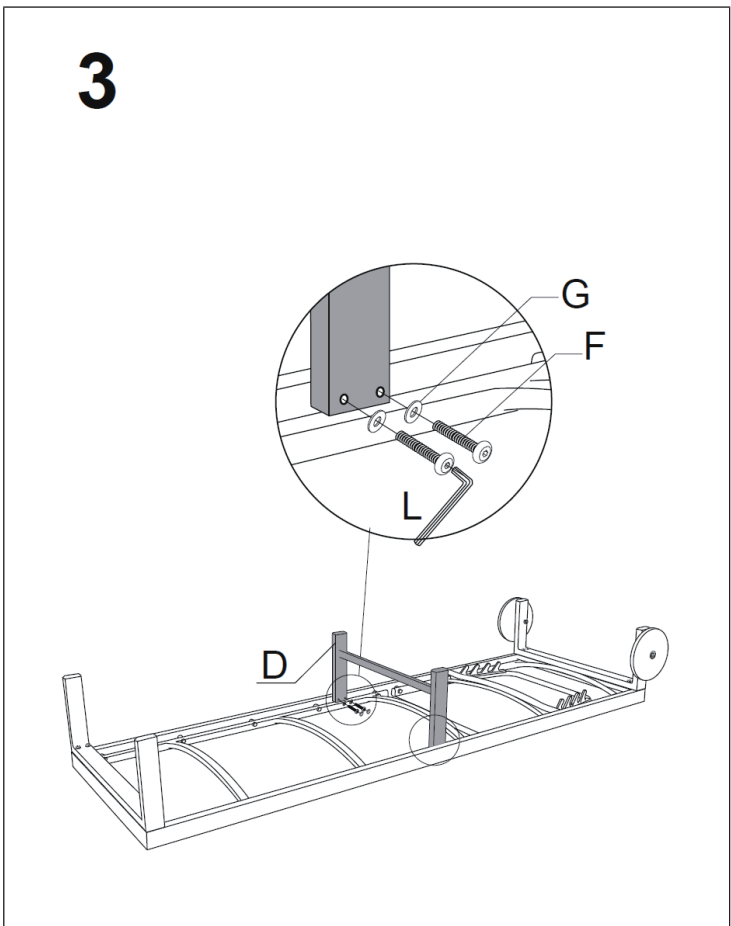



## POSIBLES USOS

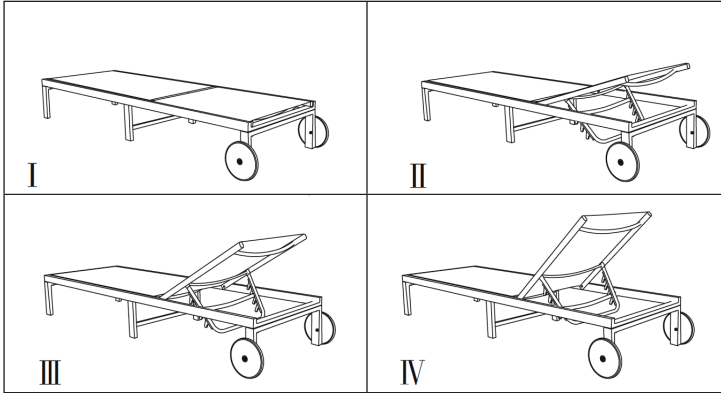

**¡Peligro de lesiones! No utilice la cama solar como se indica a continuación:**

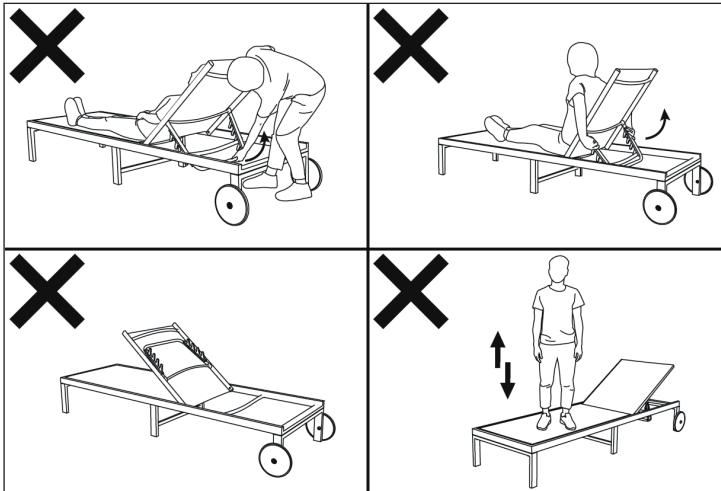

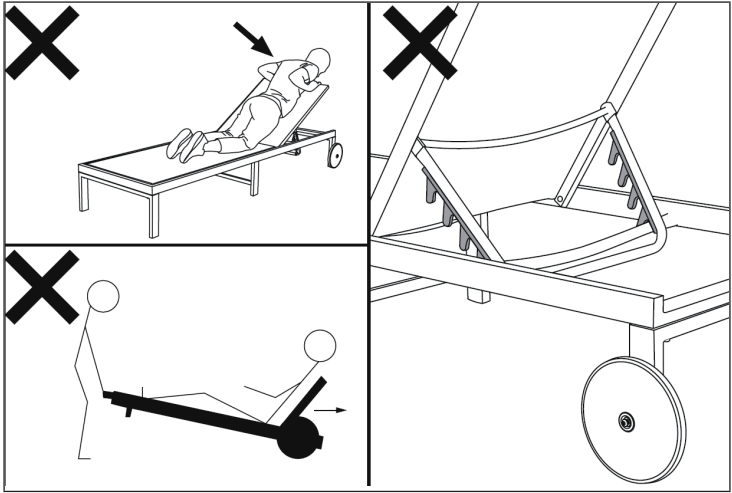

**Chère cliente, cher client,**

Toutes nos félicitations pour l'acquisition de ce nouvel appareil. Veuillez lire attentivement et respecter les instructions de ce mode d'emploi afin d'éviter d'éventuels dommages. Nous ne saurions être tenus pour responsables des dommages dus au non-respect des consignes et à la mauvaise utilisation de l'appareil. Scannez le QR-Code pour obtenir la dernière version du mode d'emploi et des informations supplémentaires concernant le produit.

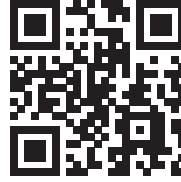

---

**SOMMAIRE**

---

Consignes de sécurité 28  
Conseils pour l'assemblage 28  
Aperçu et pièces détachées 29  
Assemblage 30  
Utilisations possibles 33

---

**FABRICANT**

---

Chal-Tec GmbH, Wallstraße 16, 10179 Berlin, Allemagne.

---

## CONSIGNES DE SÉCURITÉ

---

Le bain de soleil et les pièces associées sont en aluminium combiné avec un matériau textile. Le mobilier de jardin est exposé à des influences environnementales, telles que de grandes variations de température, l'humidité et le rayonnement intense du soleil. Afin que vous puissiez profiter de votre bain de soleil plus longtemps, respectez les consignes suivantes :

- Évitez tout contact prolongé avec l'humidité et l'eau stagnante. Rangez vos meubles à l'intérieur quand il pleut ou recouvrez-les d'une housse de protection. En cas de courtes averses de pluie, inclinez les meubles légèrement après la pluie pour éliminer l'eau. Lorsque vous recouvrez le meuble pour une période prolongée, assurez une circulation d'air adéquate.
- Nous vous recommandons de laisser les taies sur l'oreiller pour le nettoyage au lieu de les retirer. Nettoyez l'extérieur de la taie d'oreiller à l'eau claire avec une brosse douce. Retirez la saleté tenace avec un peu d'eau savonneuse, puis essuyez avec un chiffon propre et de l'eau claire. Faites sécher les coussins à l'air après le nettoyage ou avant le stockage. Ne mettez jamais les tissus dans le lave-linge ou le sèche-linge.
- Évitez le contact avec les écrans solaires ou les agents de bronzage.
- Les vis sont en inox pour une plus grande durabilité. Ne serrez pas trop les vis.
- Le cadre est à revêtement pulvérisé. L'utilisation et le transport peuvent endommager la peinture. Retouchez-la à temps avec un tampon de peinture pour éviter la rouille.
- Protégez le bain de soleil des rayonnements excessifs du soleil lorsqu'il n'est pas utilisé, sinon la couleur pourrait s'estomper.
- Rangez la chaise longue dans un endroit frais, sec et hors gel en hiver. La chaise longue n'est pas résistante à l'hiver.
- Veuillez utiliser les différents éléments uniquement pour vous asseoir ou vous allonger. Ils ne sont pas destinés à remplacer une échelle ou à servir d'appareil de gymnastique pour les enfants.
- Le bain de soleil et toutes les pièces associées sont uniquement destinés à un usage privé.

**Remarque :** Les chaises et les transats peuvent supporter jusqu'à 100 kg, les bancs à deux places jusqu'à 160 kg et les bancs à trois places jusqu'à 240 kg.













---

## CONSEILS POUR L'ASSEMBLAGE

---

- Assemblez les différentes pièces sur un tapis pour ne pas les endommager lors du montage.
- Ne serrez pas les vis à fond tant que toutes les vis de l'élément ne sont pas en place.

## APERÇU ET PIÈCES DÉTACHÉES

Pièces détachées					
A		1	H		2
B		1	I		4
C		1	J		2
D		1	K		2
E		2	L		1
F		12	M		1
G		12			

## ASSEMBLAGE

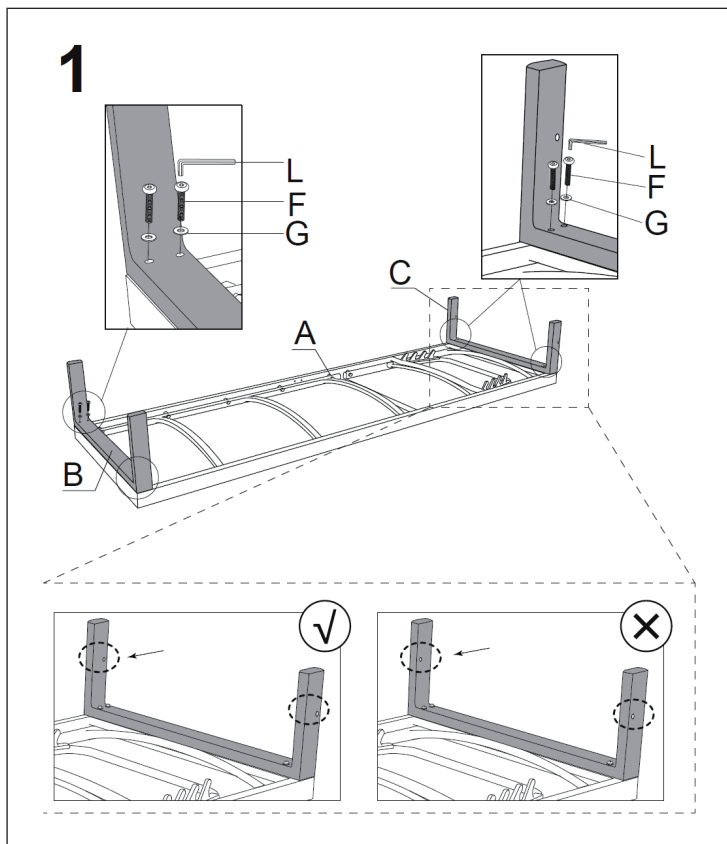

# 2

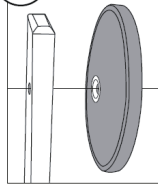
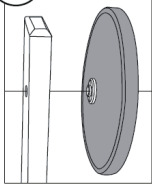
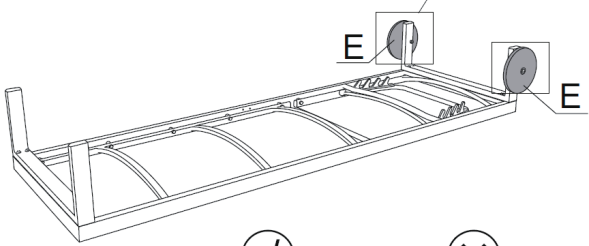
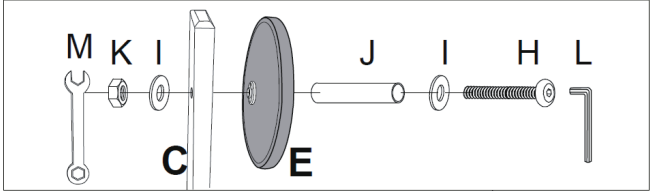

# 3

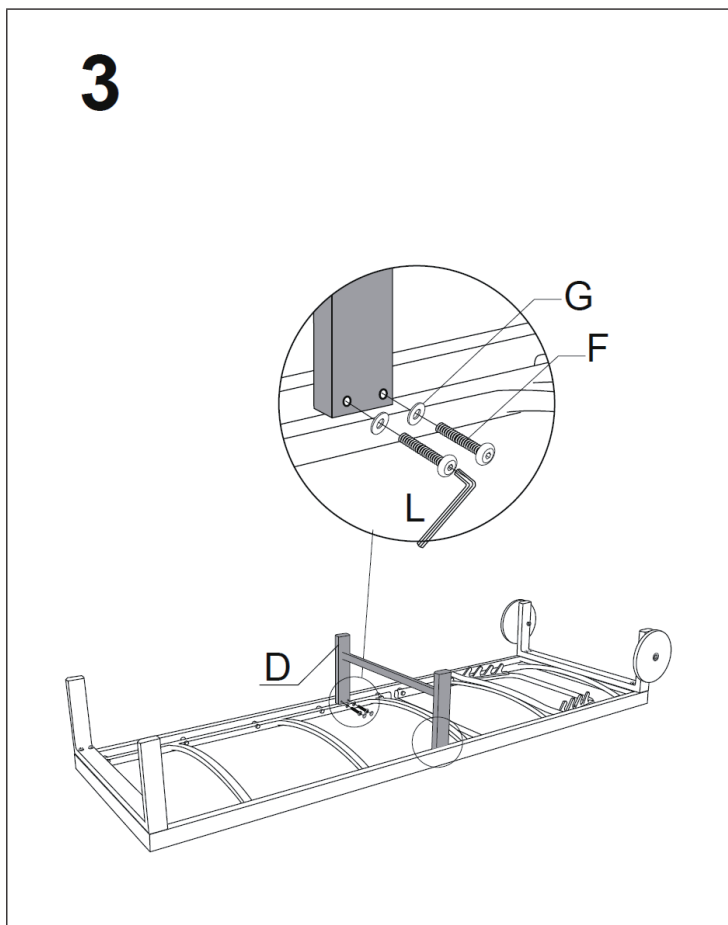



## UTILISATIONS POSSIBLES

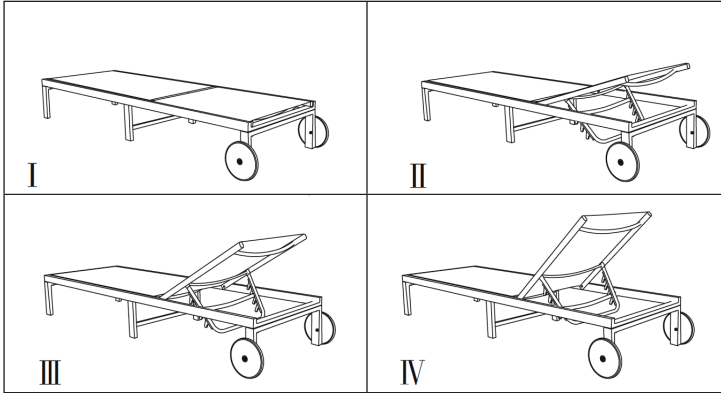

**Risque de blessure ! N'utilisez pas le solarium comme suit :**

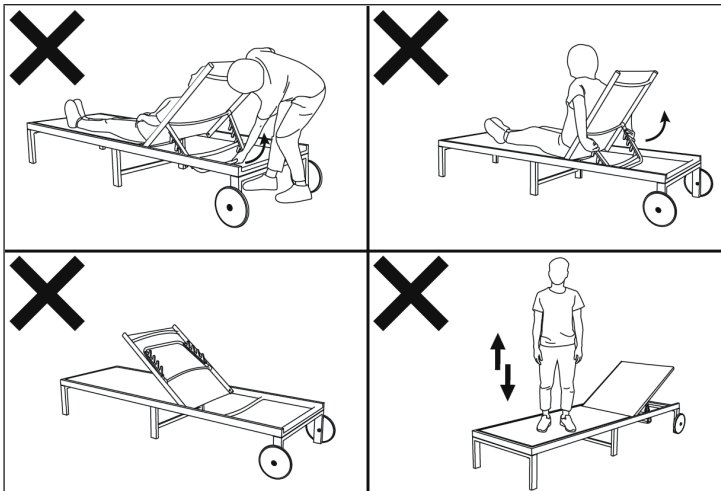

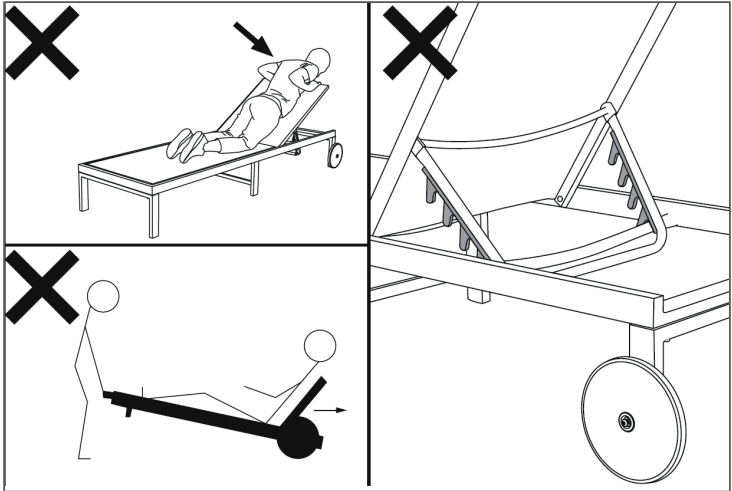

**Gentile cliente,**

La ringraziamo per aver acquistato il dispositivo. La preghiamo di leggere attentamente le seguenti istruzioni per l'uso e di seguirle per evitare possibili danni. Non ci assumiamo alcuna responsabilità per danni scaturiti da una mancata osservazione delle avvertenze di sicurezza e da un uso improprio del dispositivo. Scansionare il codice QR seguente, per accedere al manuale d'uso più attuale e per ricevere informazioni sul prodotto.

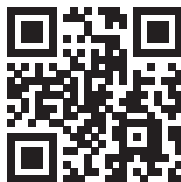

---

**INDICE**

---

Avvertenze di sicurezza 36  
Avvertenze sul montaggio 36  
Panoramica e singoli componenti 37  
Montaggio 38  
Utilizzi possibili 41

---

**PRODUTTORE**

---

Chal-Tec GmbH, Wallstraße 16, 10179 Berlino, Germania.

---

## AVVERTENZE DI SICUREZZA

---

La sedia a sdraio e i suoi componenti sono realizzati con una combinazione di alluminio e materiali tessili. I mobili da giardino sono esposti agli influssi ambientali, come grandi cambi di temperatura, umidità e intensa irradiazione solare. Seguite queste avvertenze per godervi la vostra sdraio a lungo:

- Evitare il contatto prolungato con umidità e acqua stagnante. Portare in casa i mobili da giardino durante piogge o coprirli con un'apposita copertura. In caso di brevi temporali, inclinare leggermente i mobili dopo la pioggia e asciugare l'umidità con un panno. Se rimangono coperti a lungo, garantire una circolazione d'aria sufficiente.
- Consigliamo di lasciare le federe sui cuscini durante la pulizia. Pulire la copertura esterna con acqua pulita e una spazzola morbida. Rimuovere macchie ostinate con una soluzione di acqua e sapone e un panno e sciacquare con acqua. Lasciare asciugare completamente i cuscini all'aria aperta dopo la pulizia e prima di metterli via. Non mettere mai i tessuti in lavatrice o asciugatrice.
- Evitare il contatto con prodotti di protezione solare o abbronzanti.
- Le viti sono realizzate in acciaio inox per garantire maggiore durata. Non stringere troppo le viti.
- Il telaio è verniciato a polveri. Attraverso trasporto e utilizzo possono insorgere danni alla verniciatura. Ripassare immediatamente le zone rovinate in modo da evitare la formazione di ruggine.
- In caso di non utilizzo, proteggere la sdraio da eccessiva irradiazione solare, altrimenti potrebbe scolorirsi.
- Durante l'inverno, conservare la sdraio in un luogo fresco, asciutto e privo di gelo. La sdraio non è resistente alle condizioni invernali.
- Utilizzare i singoli componenti solo per sedersi e sdraiarsi. Non sono adatti come sostituzione per una scaletta o come attrezzo da ginnastica per i bambini.
- La sdraio e i suoi componenti sono adatti solo per uso privato.

**Nota:** sedie e sdraio sono adatte a un carico fino a 100 kg, panche a due posti fino a 160 kg e panche a tre posti fino a 240 kg.













---

## AVVERTENZE SUL MONTAGGIO

---

- Montare i singoli componenti su un tappeto, in modo da non danneggiarli.
- Stringere le viti solo dopo che tutte le vite dei componenti strutturali sono posizionate correttamente.

## PANORAMICA E SINGOLI COMPONENTI

Singoli componenti					
A		1	H		2
B		1	I		4
C		1	J		2
D		1	K		2
E		2	L		1
F		12	M		1
G		12			

# MONTAGGIO

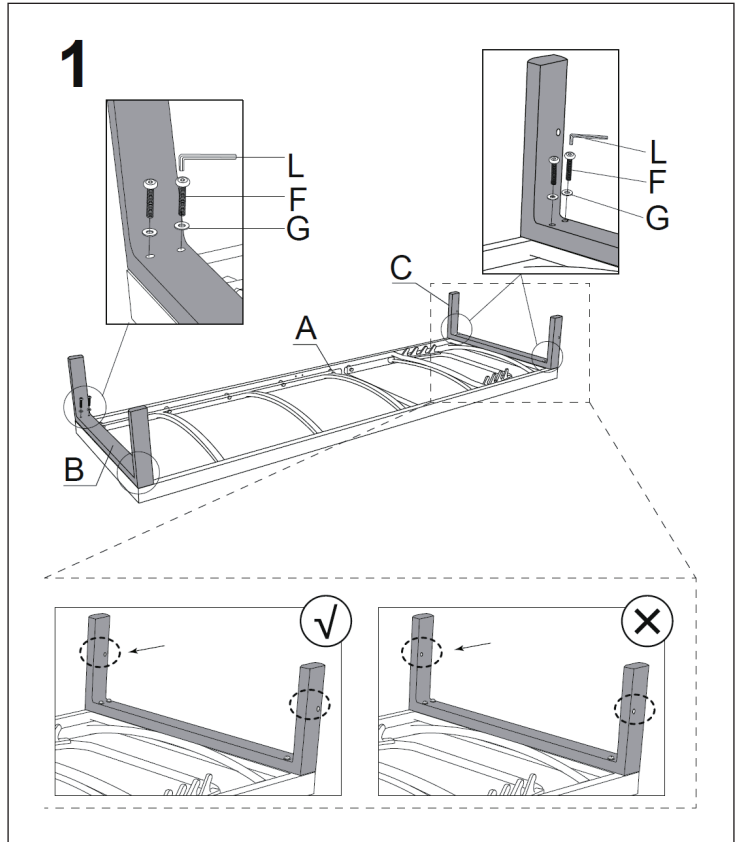

# 2

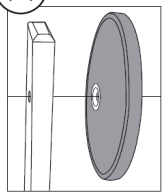
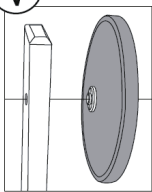
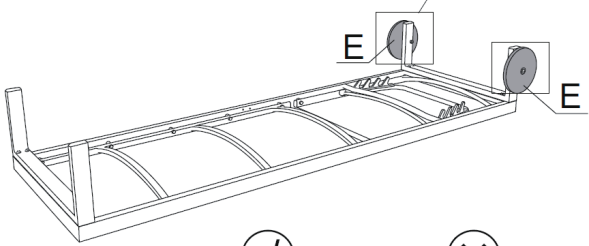
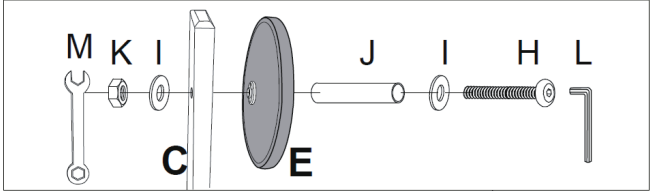

# 3

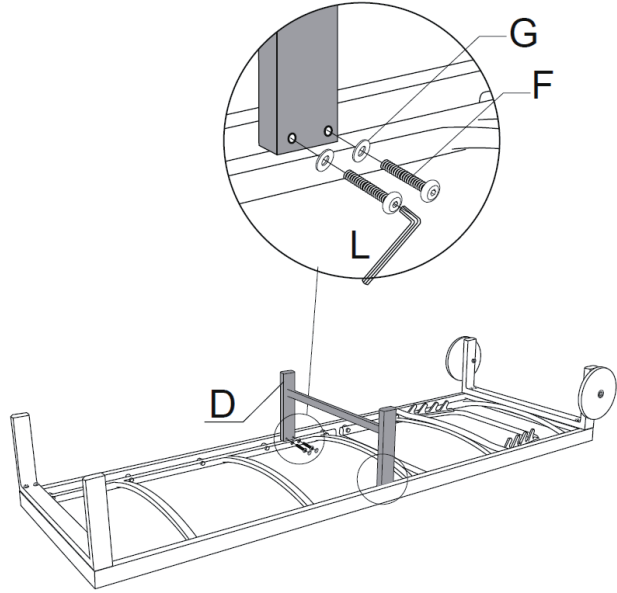



## UTILIZZI POSSIBILI

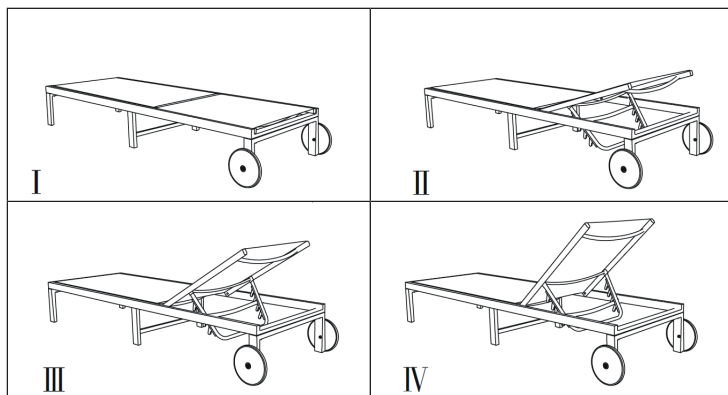

**Pericolo di lesioni! Non utilizzare la sdraio come segue:**

