



blumfeldt

Celesto | Kaiana

Toilettensitz

Toilet Seat

Asiento del inodoro

Siège de toilette

Tavoletta per WC

10036241 10036248



Sehr geehrter Kunde,

wir gratulieren Ihnen zum Erwerb Ihres Gerätes. Lesen Sie die folgenden Hinweise sorgfältig durch und befolgen Sie diese, um möglichen Schäden vorzubeugen. Für Schäden, die durch Missachtung der Hinweise und unsachgemäßen Gebrauch entstehen, übernehmen wir keine Haftung. Scannen Sie den folgenden QR-Code, um Zugriff auf die aktuellste Bedienungsanleitung und weitere Informationen rund um das Produkt zu erhalten:



INHALTSVERZEICHNIS

Montage mit Dübeln 4
 Montage mit Schrauben 5
 Pflegehinweise 6
 Hersteller & Importeur (UK) 6

English 7
Español 11
Français 15
Italiano 19

MATERIALZUSAMMENSETZUNG

Scharniere	Edelstahl/Kunststoff
Soft Close Dämpferset	Hydraulische Dämpfer aus Kunststoff
Dämpferflüssigkeit	Gleitflüssigkeit
Puffer	Polyethylen
Hinweis: Das Material des Toilettensitzes besteht aus durchgefärbtem Duroplast (UF A 10, Harnstoff-Formaldehydharz), welches frei von umweltschädlichen Stoffen ist. Duroplast wird produziert aus 69% Ureaformaldehydharz, 28% Cellulose, 3% Mineralien, Pigmente, Schmierstoffe und Feuchtigkeit.	

MONTAGE MIT DÜBELN

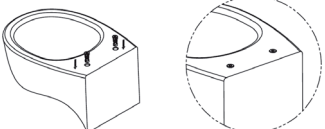
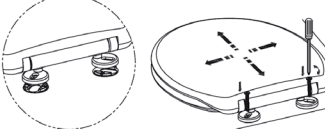
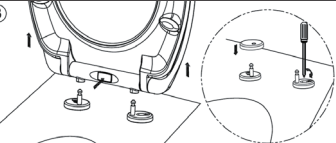
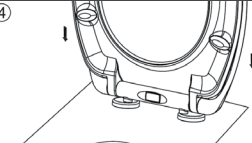
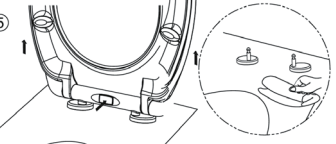
<p>①</p> 	<p>②</p> 
<p>Setzen Sie die Spreizdübel in die Aussparung der Toilette.</p>	<p>Befestigen Sie die Antirutschscheibe auf der Unterseite des schwarzen Scharniers und setzen Sie beides auf die Aussparung der Toilette. Führen Sie die Schrauben durch den Schlitz der Scharniere in die eingesetzten Spreizdübel. Ziehen Sie die Schrauben nicht ganz fest und setzen Sie dann den Toilettensitz auf die Scharniere. Jetzt können Sie den Toilettensitz ausrichten.</p>
<p>③</p> 	<p>④</p> 
<p>Nehmen Sie den Toilettensitz wieder ab. Ziehen Sie die Schrauben fest und setzen Sie die Edelstahlabdeckung auf die Scharniere.</p>	<p>Setzen Sie den Toilettensitz wieder auf die Scharniere.</p>
<p>⑤</p> 	<p>Für die Installation benötigt:</p> <ul style="list-style-type: none"> Schraubenzieher Toilettensitz (1x) Spreizdübel (2x) Scharniere (2x) Antirutschscheiben (2x) Schrauben (2x) Scharnierabdeckungen (2x)
<p>Wenn Sie den Knopf 1x drücken, können Sie den Toilettensitz danach mit beiden Händen abnehmen.</p>	

MONTAGE MIT SCHRAUBEN

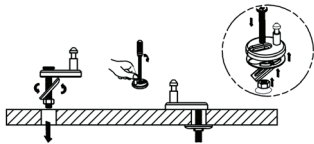
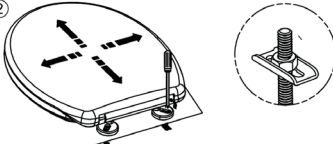
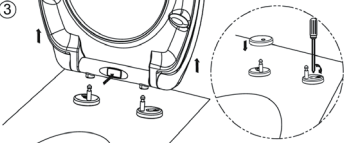
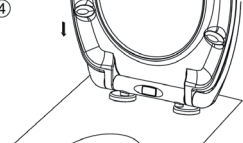
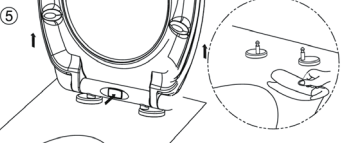
<p>①</p> 	<p>②</p> 
<p>Legen Sie die Antirutschscheibe auf das schwarze Scharnier, setzen Sie dann die Schraube durch den Schlitz des Scharniers ein. Setzen Sie die U-förmige Metallhalterung auf die Schraube und bringen Sie die Mutter an. Setzen Sie alles in die Aussparung des WC-Beckens. Halten Sie das Scharnier fest und ziehen Sie die Schraube so fest, dass sie fest noch bewegt werden kann.</p>	<p>Setzen Sie den Toilettensitz auf den Scharniersockel, um den Sitz an das WC-Becken anzupassen. Passen Sie die Position des Sitzes an, bis er richtig sitzt, und ziehen Sie die Schraube fest.</p>
<p>③</p> 	<p>④</p> 
<p>Nehmen Sie den Toilettensitz wieder ab. Ziehen Sie die Schrauben fest und setzen Sie die Edelstahlabdeckung auf die Scharniere.</p>	<p>Setzen Sie den Toilettensitz wieder auf die Scharniere.</p>
<p>⑤</p> 	<p>Für die Installation benötigt:</p> <ul style="list-style-type: none"> Schraubenzieher Toilettensitz (1x) Metallhalterungen (2x) Scharniere (2x) Antirutschscheiben (2x) Schrauben (2x) Scharnierabdeckungen (2x) Muttern (2x)
<p>Wenn Sie den Knopf 1x drücken, können Sie den Toilettensitz danach mit beiden Händen abnehmen.</p>	

PFLEGEHINWEISE

Dieser Toilettensitz wurde mit Sorgfalt hergestellt. Wenn Sie ein paar einfache Reinigungshinweise beachten, wird er Sie jeden Tag aufs neue mit seiner Schönheit, seinem Komfort und seiner Qualität erfreuen.

- Die Oberfläche des Toilettensitzes ist geschlossen und porenfrei, was zur Sicherung der optimalen Hygiene beiträgt. Verwenden Sie keine scheuernden, chlorhaltigen oder säurehaltigen Reinigungsmittel, da diese die Oberfläche beschädigen und gelbliche Verfärbungen hervorrufen können.
- Verwenden Sie für die Reinigung nur eine milde, PH-neutrale Seifenlösung.
- Ist der Toilettensitz oder die Scharniere in Kontakt mit WC-Reiniger oder anderen aggressiven Reinigungsmitteln gekommen, spülen Sie ihn umgehend mit klarem Wasser ab.
- Wischen Sie nach der Reinigung eventuell verbleibende Feuchtigkeit auf dem Sitz und den Scharnieren mit einem weichen Tuch ab.
- Achten Sie bei der Reinigung darauf, dass der Toilettensitz und der Deckel geöffnet oder abgenommen sind, bis das Reinigungsmittel im Becken vollständig weggespült ist.

HERSTELLER & IMPORTEUR (UK)

Hersteller:

Chal-Tec GmbH, Wallstraße 16, 10179 Berlin, Deutschland.

Importeur für Großbritannien:

Chal-Tec UK limited
Unit 6 Riverside Business Centre
Brighton Road
Shoreham-by-Sea
BN43 6RE
United Kingdom

Dear Customer,

Congratulations on purchasing this device. Please read the following instructions carefully and follow them to prevent possible damages. We assume no liability for damage caused by disregard of the instructions and improper use. Scan the QR code to get access to the latest user manual and more product information.



CONTENTS

Mounting with Dowels 8

Mounting with Screws 9

Care Instructions 10

Manufacturer & Importer (UK) 10

MATERIAL COMPOSITION

Hinges	Stainless steel/plastic
Soft Close damper set	Hydraulic dampers made of plastic
Damper fluid	Sliding fluid
Buffer	Polyethylene

Note: The material of the toilet seat is made of duroplast (UF A 10, urea formaldehyde resin) dyed through, which is free from environmentally harmful substances. Thermoset is produced from 69% urea formaldehyde resin, 28% cellulose, 3% minerals, pigments, lubricants and moisture.

MOUNTING WITH DOWELS

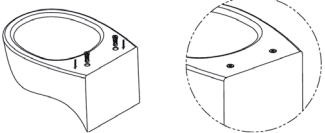
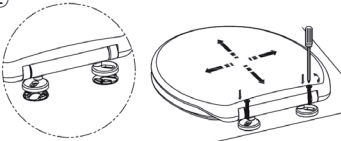
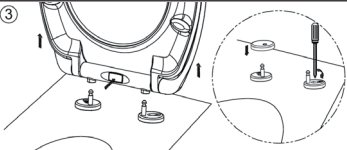
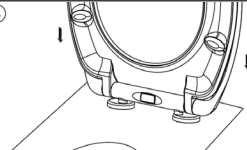
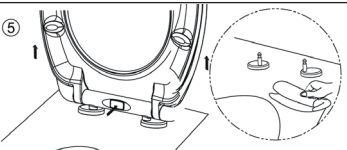
<p>①</p> 	<p>②</p> 
<p>Place the expansion dowels in the recess of the toilet.</p>	<p>Attach the anti-slip washer to the bottom of the black hinge and place both on the recess of the toilet. Insert the screws through the slot of the hinges into the inserted expansion anchors. Do not tighten the screws completely and then place the toilet seat on the hinges. Now you can align the toilet seat.</p>
<p>③</p> 	<p>④</p> 
<p>Remove the toilet seat again. Tighten the screws and place the stainless steel cover on the hinges.</p>	<p>Place the toilet seat back on the hinges.</p>
<p>⑤</p> 	<p>Required for installation:</p> <ul style="list-style-type: none"> Screwdriver Toilet seat (1x) Expansion dowels (2x) Hinges (2x) Anti-slip washers (2x) Screws (2x) Hinge covers (2x)
<p>If you press the button 1x, you can remove the toilet seat with both hands afterwards.</p>	

MOUNTING WITH SCREWS

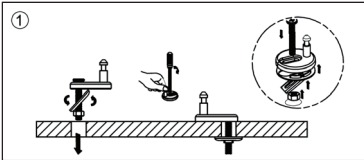
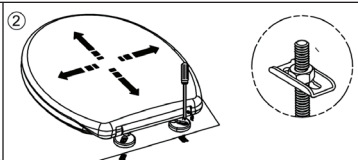
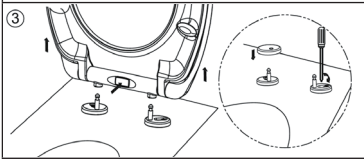
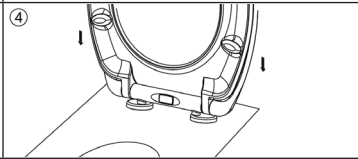
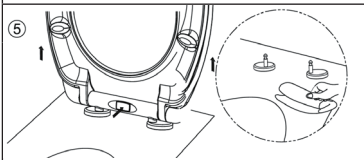
	
<p>Place the anti-slip washer on the black hinge, then insert the screw through the slot of the hinge. Place the U-shaped metal bracket on the screw and attach the nut. Place everything into the recess of the toilet bowl. Hold the hinge firmly and tighten the screw so that it can still be moved tightly.</p>	<p>Place the toilet seat on the hinge base to fit the seat to the toilet bowl. Adjust the position of the seat until it fits properly and tighten the screw.</p>
	
<p>Remove the toilet seat again. Tighten the screws and place the stainless steel cover on the hinges.</p>	<p>Place the toilet seat back on the hinges.</p>
	<p>Required for installation:</p> <ul style="list-style-type: none"> Screwdriver Toilet seat (1x) Metal brackets (2x) Hinges (2x) Anti-slip washers (2x) Screws (2x) Hinge covers (2x) Nuts (2x)
<p>If you press the button 1x, you can remove the toilet seat with both hands afterwards.</p>	

CARE INSTRUCTIONS

This toilet seat was made with care. If you follow a few simple cleaning instructions, it will delight you with its beauty, comfort and quality every day.

- The surface of the toilet seat is closed and non-porous, which helps to ensure optimal hygiene. Do not use abrasive, chlorine or acidic detergents, as they can damage the surface and cause yellowish discoloration.
- Use only a mild, PH-neutral soap solution for cleaning.
- If the toilet seat or hinges have come into contact with toilet cleaner or other aggressive cleaning agents, rinse them immediately with clean water.
- After cleaning, wipe off any remaining moisture on the seat and hinges with a soft cloth.
- When cleaning, make sure that the toilet seat and lid are open or removed until the cleaning agent in the bowl is completely flushed away.

MANUFACTURER & IMPORTER (UK)

Manufacturer:

Chal-Tec GmbH, Wallstrasse 16, 10179 Berlin, Germany.

Importer for Great Britain:

Chal-Tec UK limited
Unit 6 Riverside Business Centre
Brighton Road
Shoreham-by-Sea
BN43 6RE
United Kingdom

Estimado cliente,

Le felicitamos por la adquisición de este producto. Lea atentamente las siguientes instrucciones y sígalas para evitar posibles daños. No asumimos ninguna responsabilidad por los daños causados por el incumplimiento de las instrucciones y el uso inadecuado. Escanee el siguiente código QR para obtener acceso a la última guía del usuario y más información sobre el producto.



ÍNDICE

Montaje con tacos de expansión	12
Montaje con tornillos	13
Instrucciones de cuidado	14
Fabricante e importador (Reino Unido)	14

COMPOSICIÓN DE LOS MATERIALES

Bisagras	Acero inoxidable/plástico
Juego de amortiguadores de cierre suave	Amortiguadores hidráulicos de plástico
Fluido amortiguador	Fluido deslizante
Tope	Polietileno

Nota: El material del asiento del inodoro tiene un teñido termoestable (UF A 10, resina de urea-formaldehído), que no contiene sustancias nocivas para el medio ambiente. El termoestable se produce a partir de un 69% de resina de urea formaldehído, un 28% de celulosa, un 3% de minerales, pigmentos, lubricantes y humedad.

MONTAJE CON TACOS DE EXPANSIÓN

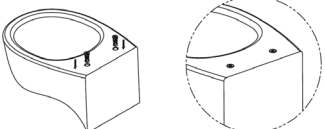
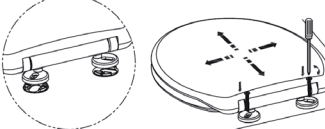
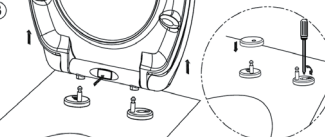
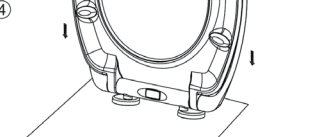
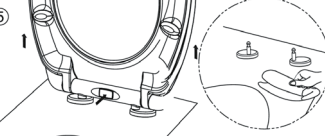
<p>①</p> 	<p>②</p> 
<p>Coloque los tacos de expansión en el hueco del inodoro.</p>	<p>Fije la arandela antideslizante a la parte inferior de la bisagra negra y coloque ambas en el hueco del inodoro. Inserte los tornillos a través de la ranura de las bisagras en los tacos de expansión insertados. No apriete los tornillos hasta el final y coloque el asiento del inodoro en las bisagras. Ahora puede alinear el asiento del inodoro.</p>
<p>③</p> 	<p>④</p> 
<p>Retire el asiento del inodoro de nuevo. Apriete los tornillos y coloque la cubierta de acero inoxidable en las bisagras.</p>	<p>Coloque el asiento del inodoro de nuevo en las bisagras.</p>
<p>⑤</p> 	<p>Se necesita para la instalación:</p> <ul style="list-style-type: none"> Destornillador Asiento del inodoro (1x) Tacos de expansión (2x) Bisagras (2x) Arandelas antideslizantes (2x) Tornillos (2x) Tapas de las bisagras (2x)
<p>Si se pulsa el botón 1 vez, se puede quitar el asiento del inodoro con ambas manos después.</p>	

MONTAJE CON TORNILLOS

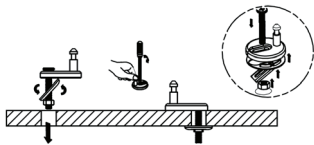
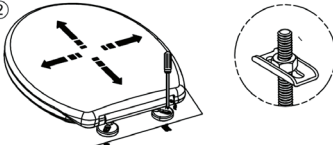
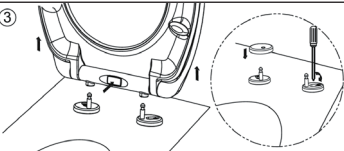
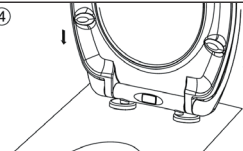
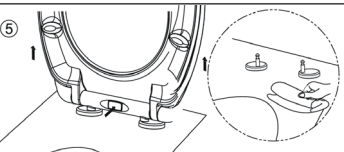
<p>①</p> 	<p>②</p> 
<p>Coloque la arandela antideslizante en la bisagra negra y luego introduzca el tornillo a través de la ranura de la bisagra. Coloque el soporte metálico en forma de U sobre el tornillo y ponga la tuerca. Coloque todo en el hueco de la taza del váter. Sujete la bisagra con firmeza y apriete el tornillo para que pueda seguir moviéndose.</p>	<p>Coloque el asiento del inodoro en la base de la bisagra para ajustar el asiento a la taza del inodoro. Ajuste la posición del asiento hasta que se ajuste correctamente y apriete el tornillo.</p>
<p>③</p> 	<p>④</p> 
<p>Apriete los tornillos y coloque la cubierta de acero inoxidable en las bisagras.</p>	<p>Coloque el asiento del inodoro de nuevo en las bisagras.</p>
<p>⑤</p> 	<p>Se necesita para la instalación:</p> <ul style="list-style-type: none"> Destornillador Asiento del inodoro (1x) Tacos de expansión (2x) Bisagras (2x) Arandelas antideslizantes (2x) Tornillos (2x) Tapas de las bisagras (2x) Tuercas (2x)
<p>Si se pulsa el botón 1 vez, se puede quitar el asiento del inodoro con ambas manos después.</p>	

INSTRUCCIONES DE CUIDADO

Este asiento de inodoro ha sido fabricado con mucha atención. Si sigue unas sencillas instrucciones de limpieza, le deleitará con su belleza, comodidad y calidad cada día.

- La superficie del asiento del inodoro es cerrada y no porosa, lo que contribuye a garantizar una higiene óptima. No utilice productos de limpieza abrasivos, clorados o ácidos, ya que pueden dañar la superficie y provocar una decoloración amarillenta.
- Utilice sólo una solución jabonosa suave y de PH neutro para la limpieza.
- Si el asiento del inodoro o las bisagras han entrado en contacto con el limpiador de WC u otros productos de limpieza agresivos, aclárelo inmediatamente con agua limpia.
- Después de la limpieza, elimine los restos de humedad en el asiento y las bisagras con un paño suave.
- Al limpiar, asegúrese de que el asiento del inodoro y la tapa están abiertos hasta que el producto de limpieza de la cubeta se haya enjuagado por completo.

FABRICANTE E IMPORTADOR (REINO UNIDO)

Fabricante:

Chal-Tec GmbH, Wallstraße 16, 10179 Berlín, Alemania.

Importador para Gran Bretaña:

Chal-Tec UK limited
Unit 6 Riverside Business Centre
Brighton Road
Shoreham-by-Sea
BN43 6RE
United Kingdom

Chère cliente, cher client,

Toutes nos félicitations pour l'acquisition de ce nouvel appareil. Veuillez lire attentivement et respecter les instructions de ce mode d'emploi afin d'éviter d'éventuels dommages. Nous ne saurions être tenus pour responsables des dommages dus au non-respect des consignes et à la mauvaise utilisation de l'appareil. Scannez le QR-Code pour obtenir la dernière version du mode d'emploi et des informations supplémentaires concernant le produit.



SOMMAIRE

Montage avec des chevilles 16
Montage vissé 17
Conseils d'entretien 18
Fabricant et importateur (UK) 18

LISTE DES PIÈCES

Charnières	Inox/plastique
Système d'amortissement Soft Close	Amortisseurs hydrauliques en plastique
Liquide d'amortisseurs	Lubrifiant
Tampon	Polyéthylène

Remarque : Le matériau du siège de toilette est constitué de duroplast coloré (UF A 10, résine urée-formaldéhyde) et ne contient aucune substance nocive pour l'environnement. Le duroplast est composé de 69 % de résine urée-formaldéhyde, 28 % de cellulose, 3 % de minéraux, de pigments, de lubrifiants et d'eau.

MONTAGE AVEC DES CHEVILLES

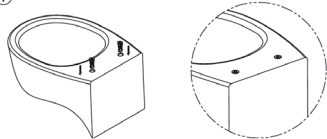
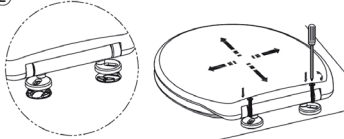
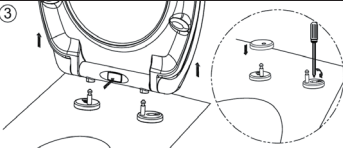
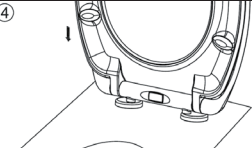
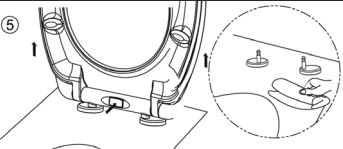
<p>①</p> 	<p>②</p> 
<p>Placez la cheville à expansion dans l'emplacement sur la cuvette des toilettes.</p>	<p>Fixez la rondelle antidérapante sous la charnière noire et placez les deux sur l'emplacement de la cuvette des toilettes. Faites passer les vis à travers la fente de la charnière dans la cheville à extension insérée. Ne serrez pas complètement les vis, puis placez le siège des toilettes sur les charnières. Vous pouvez maintenant aligner le siège des toilettes.</p>
<p>③</p> 	<p>④</p> 
<p>Retirez à nouveau le siège des toilettes. Serrez les vis et placez le cache en inox sur les charnières.</p>	<p>Remettez le siège des toilettes sur les charnières.</p>
<p>⑤</p> 	<p>Ce qu'il vous faut pour l'installation :</p> <ul style="list-style-type: none"> Tournevis Siège toilettes (1x) Chevilles à expansion (2x) Charnières (2x) Rondelles antidérapantes (2x) Vis (2x) Caches de charnières (2x)
<p>Appuyez une fois sur le bouton pour retirer le siège des toilettes à deux mains.</p>	

MONTAGE VISSÉ

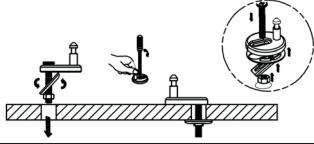
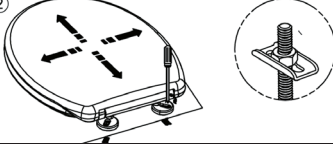
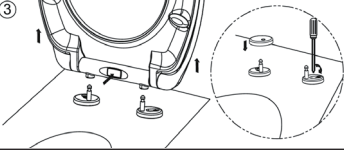
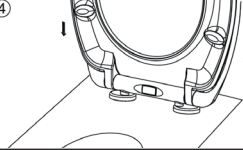
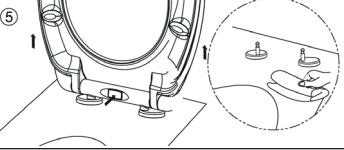
<p>①</p> 	<p>②</p> 
<p>Placez la rondelle antidérapante sur la charnière noire, puis insérez la vis dans la fente de la charnière. Placez le support métallique en forme de U sur la vis et fixez l'écrou. Mettez tout dans l'emplacement de la cuvette des toilettes. Tenez la charnière et serrez la vis de manière à pouvoir toujours la déplacer en toute sécurité.</p>	<p>Placez le siège des toilettes sur la base de la charnière pour faire correspondre le siège à la cuvette des toilettes. Ajustez la position du siège jusqu'à ce qu'il soit correctement installé et serrez la vis.</p>
<p>③</p> 	<p>④</p> 
<p>Retirez à nouveau le siège des toilettes. Serrez les vis et placez le cache en inox sur les charnières.</p>	<p>Remettez le siège des toilettes sur les charnières.</p>
<p>⑤</p> 	<p>Ce qu'il vous faut pour l'installation :</p> <ul style="list-style-type: none"> Tournevis Siège de toilettes (1x) Supports métalliques (2x) Charnières (2x) Rondelles antidérapantes (2x) Vis (2x) Caches de charnières (2x) Écrous (2x)
<p>Appuyez une fois sur le bouton pour retirer le siège des toilettes à deux mains.</p>	

CONSEILS D'ENTRETIEN

Ce siège de toilette a été fabriqué avec soin. Si vous suivez quelques instructions de nettoyage simples, sa beauté, son confort et sa qualité vous satisferont tous les jours.

- La surface du siège des toilettes est fermée et non poreuse pour assurer une hygiène optimale. N'utilisez pas d'agents de nettoyage abrasifs, à base de chlore ou acides, car ils peuvent endommager la surface et provoquer une décoloration jaune.
- Utilisez uniquement une solution savonneuse douce au pH neutre pour le nettoyage.
- Si le siège des toilettes ou la charnière est entré en contact avec du nettoyant pour toilettes ou d'autres agents de nettoyage agressifs, rincez-les immédiatement à l'eau claire.
- Après le nettoyage, essuyez toute trace d'humidité sur le siège et les charnières avec un chiffon doux.
- Lors du nettoyage, assurez-vous que la lunette et le couvercle des toilettes sont ouverts ou retirés jusqu'à ce que le détergent dans le bassin ait été complètement rincé.

FABRICANT ET IMPORTATEUR (UK)

Fabricant :

Chal-Tec GmbH, Wallstraße 16, 10179 Berlin, Allemagne.

Importateur pour la Grande Bretagne :

Chal-Tec UK limited
Unit 6 Riverside Business Centre
Brighton Road
Shoreham-by-Sea
BN43 6RE
United Kingdom

Gentile cliente,

La ringraziamo per aver acquistato il dispositivo. La preghiamo di leggere attentamente le seguenti istruzioni per l'uso e di seguirle per evitare possibili danni. Non ci assumiamo alcuna responsabilità per danni scaturiti da una mancata osservazione delle avvertenze di sicurezza e da un uso improprio del dispositivo. Scansionare il codice QR seguente, per accedere al manuale d'uso più attuale e per ricevere informazioni sul prodotto.



INDICE

Montaggio con tasselli 20

Montaggio con viti 21

Indicazioni sulla cura dell'articolo 22

Produttore e importatore (UK) 22

COMPOSIZIONE MATERIALI

Cerniera	Acciaio inox/plastica
Set ammortizzatori Soft Close	Ammortizzatori idraulici in plastica
Liquido ammortizzatori	Liquido di scorrimento
Buffer	Polietilene
<p>Nota: il materiale della tavoletta per WX è composto da Duroplast colorato (UF A 10, urea-formaldeide), che è priva di sostanze nocive per l'ambiente. Duroplast composto al 69% da urea-formaldeide, al 28% da cellulosa, al 3% da minerali, pigmenti, lubrificanti e umidità.</p>	

MONTAGGIO CON TASSELLI

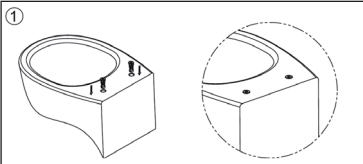
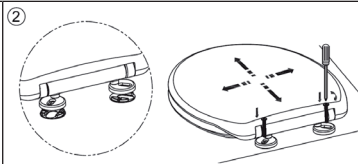
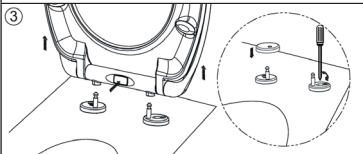
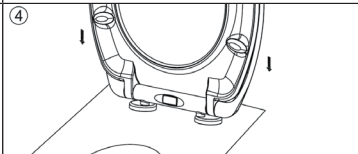
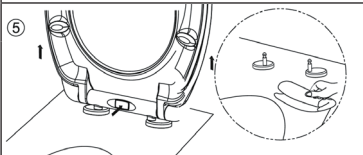
	
<p>① Inserire i tasselli a espansione nei fori sul WC.</p>	<p>② Fissare i dischetti antiscivolo sul lato inferiore della cerniera nera e inserirli nei fori del WC. Far passare le viti nelle fessure delle cerniere, inserendole nei tasselli a espansione posizionati in precedenza. A questo punto, non stringere saldamente le viti e posizionare la tavoletta sulle cerniere. Regolare correttamente la posizione della tavoletta.</p>
	
<p>③ Togliere nuovamente la tavoletta. Stringere saldamente le viti e posizionare le coperture di acciaio inox sulle cerniere.</p>	<p>④ Rimettere la tavoletta sulle cerniere.</p>
	<p>Per l'installazione sono necessari:</p> <ul style="list-style-type: none"> Cacciavite Tavoletta per WC (1x) Tasselli a espansione (2x) Cerniere (2x) Dischetti antiscivolo (2x) Viti (2x) Coperture cerniere (2x)
<p>⑤ Se si preme il tasto 1 volta, è possibile rimuovere la tavoletta con entrambe le mani.</p>	

MONTAGGIO CON VITI

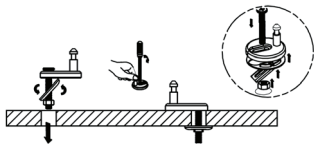
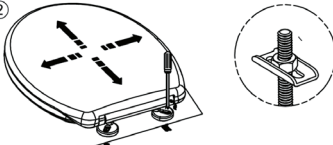
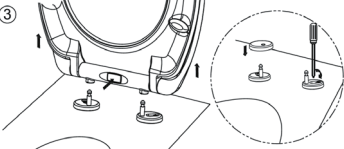
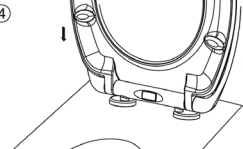
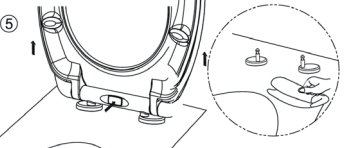
	
<p>Posizionare i dischetti antiscivolo sulle cerniere nere e inserire poi le viti nelle fessure delle cerniere. Posizionare i supporti metallici a U sulle viti e mettere il dado. Inserire il tutto nei fori della tazza del WC. Tenere saldamente la cerniera e stringere la vite in modo tale che possa essere mossa anche una volta fissata.</p>	<p>Posizionare la tavoletta sui basamenti delle cerniere, in modo da regolarla in relazione alla tazza del WC. Mettere la tavoletta in posizione corretta e stringere saldamente le viti.</p>
	
<p>Togliere nuovamente la tavoletta. Stringere saldamente le viti e posizionare le coperture di acciaio inox sulle cerniere.</p>	<p>Rimettere la tavoletta sulle cerniere.</p>
	<p>Per l'installazione sono necessari:</p> <ul style="list-style-type: none"> Cacciavite Tavoletta per WC (1x) Supporti metallici (2x) Cerniere (2x) Dischetti antiscivolo (2x) Viti (2x) Coperture cerniere (2x) Dadi (2x)
<p>Se si preme il tasto 1 volta, è possibile rimuovere la tavoletta con entrambe le mani.</p>	

INDICAZIONI SULLA CURA DELL'ARTICOLO

Questa tavoletta per WC è stata prodotta con la massima cura. Se vengono rispettate un paio di indicazioni sulla pulizia e sulla cura, vi riempirà di gioia giorno per giorno con la sua bellezza, il suo comfort e la sua qualità.

- La superficie della tavoletta è chiusa e non porosa, per garantire un'igiene ottimale. Non utilizzare detergenti abrasivi, contenenti cloro o acidi, dato che potrebbero rovinare la superficie o causare ingiallimento.
- Per la pulizia, utilizzare solo una soluzione saponosa delicata, con PH neutro.
- Se la tavoletta o le cerniere sono entrate in contatto con detergenti per WC o prodotti aggressivi, sciacquarla subito con acqua.
- Rimuovere eventuale umidità residua su tavoletta e cerniere utilizzando un panno morbido.
- Durante la pulizia, assicurarsi che la seduta e il coperchio del WC siano aperti o rimossi, fino a quando il detergente nella tazza del WC è stato completamente sciacquato.

PRODUTTORE E IMPORTATORE (UK)

Produttore:

Chal-Tec GmbH, Wallstraße 16, 10179 Berlino, Germania.

Importatore per la Gran Bretagna:

Chal-Tec UK limited
Unit 6 Riverside Business Centre
Brighton Road
Shoreham-by-Sea
BN43 6RE
United Kingdom

