

PAIR Timer - Installation guide and user instructions (Passive / Active Infra Red Timer for use with eTRV)

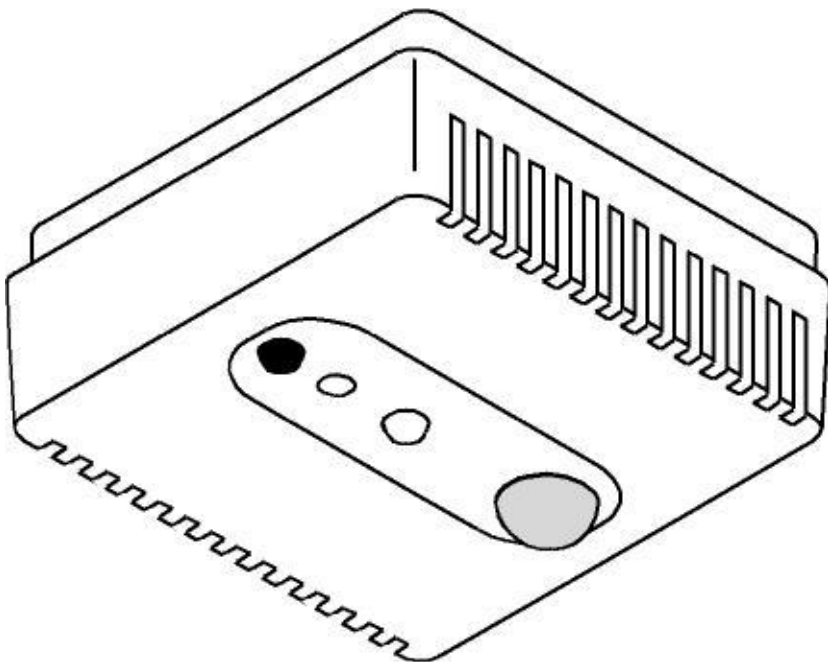

Thank you for buying the PAIR (Passive Active Infra Red) timer for use with the eTRV (electronic Thermostatic Radiator Valve).

Please take the time needed to read and understand these instructions. After you have read the manual, store it in a safe place.

eTRV and PAIR are protected under GB Patent, number 2452043.

eTRV is a registered trademark.

2014/01v1

What is a PAIR timer and how does it work?

The **PAIR** timer remotely controls an **eTRV**, to automatically operate the heating in a room. The PAIR timer saves energy by lowering the heating after a room is left empty.

To detect people in the area, PAIR uses a **Passive Infra Red** sensor to see movement.

When movement is detected, PAIR sends an **Active Infra Red** signal to the eTRV so the heating is controlled to an **occupied temperature mode** while the area is in use.

A **timer** runs and a set time after no movement has been detected (an hour or more), PAIR sends another signal to the eTRV so the heating is controlled to an **unoccupied temperature mode**.

If selected and the area remains empty, a **sleep timer** runs and a further set time after no movement has been detected, PAIR sends another signal to the eTRV so the heating is controlled to a **sleep temperature mode**.

An optional remote control and the built in LED indicator (a red, yellow or green light) allows you to programme and use the PAIR easily.

Using the remote control, the occupied temperature mode, the unoccupied temperature mode, and the sleep temperature mode can all be set. The occupancy timer and sleep timer can also be set and the PAIR settings can be locked.

PAIR is designed to fit to a wall or on a ceiling – it is easy to fit and there is no wiring as PAIR is powered using two AA batteries.

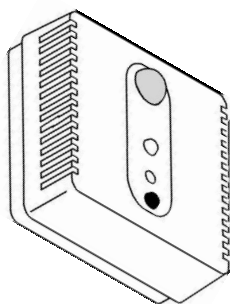

PAIR timer, wall mounted

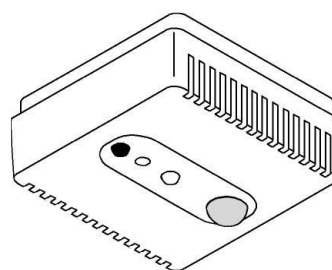

PAIR timer, ceiling mounted

Safety Instructions

If you do not use the PAIR timer correctly, in line with these operating instructions:



- the warranty will end; and
- we will not be liable for any damage or loss whatsoever, including indirect loss, damage to property or personal injury.

- The PAIR timer, remote control and accessories are not intended for use by children and must not be used as toys.
- Do not leave packaging material lying around as children might be tempted to play with it, which is extremely dangerous.
- You must only use the product in dry areas indoors, and it must be protected from moisture and water.
- Handle the product with care. It can be damaged through being hit or dropped, even from a low height.
- Do not dismantle the PAIR timer as it does not contain any parts that you need to service. If the PAIR timer arrives faulty, return it to where you bought it.

Disposal



The outer box of the packaging is made from 69% recycled material from managed forests and is 100% recyclable.

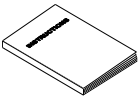

These instructions are 100% recyclable.



Do not throw this device away with your regular household waste.

You must take electronic equipment to a local tip to be disposed of in line with current regulations.



Never try to recharge standard batteries as they may explode.



Do not take batteries apart or throw them into a fire.
Do not short circuit batteries.



Do not put used batteries in your regular household rubbish. Take them to your local battery-disposal point.



If you need this guide in large print, download the instructions from www.chalmor.co.uk or scan the QR code shown opposite.



Contents

1	Introduction.....	5
2	General use.....	6
3	Getting started.....	6
3a	Fitting the batteries to the PAIR timer.....	7
3b	Fitting the batteries to the remote control.....	8
3c	Using the remote control for testing the PAIR timer.....	8
3d	Finding the best place for the PAIR timer.....	9
3e	Walk test the sensor and check the link with the eTRV.....	10
4	Fitting the PAIR timer.....	11
5	Factory settings.....	12
5a	What the LED indicator means.....	12
5b	Replacing low and dead batteries.....	12
6	Using your PAIR timer.....	13
6a	Default settings.....	13
6b	Using the remote control to adjust the PAIR timer settings.....	13
7	Choosing your PAIR timer settings.....	14
7a	Occupancy Mode Settings	15
7b	Changing the Occupancy Mode Settings.....	16
7c	Checking the Occupancy Mode Settings.....	17
7d	Occupancy and Sleep Timer Settings.....	18
7e	Changing the Occupancy and Sleep Timer Settings.....	19
7f	Checking the Occupancy and Sleep Timer Settings.....	20
8	Extra settings.....	21
8a	Adjusting the sensitivity setting of the PIR occupancy sensor.....	21
8b	Checking the sensitivity setting of the PIR occupancy sensor.....	22
8c	Lock settings.....	22
8d	Restore factory settings.....	23
9	Technical properties.....	23
10	Drawings for PAIR timer location, sensor and beam coverage.....	24

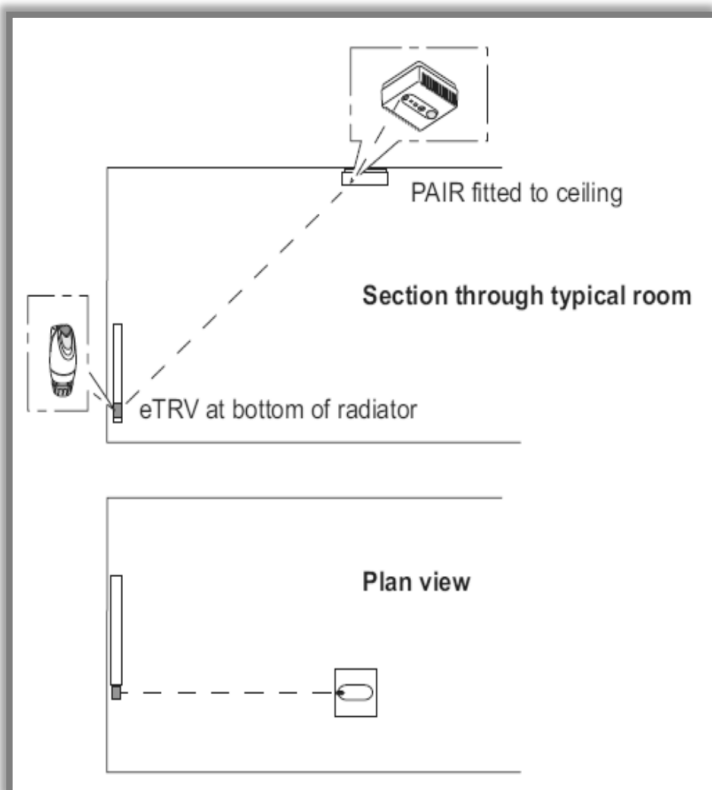

The diagram shows a typical application of a PAIR timer and eTRV.

This manual provides details on the PAIR timer installation and setting procedure.







For more information, visit www.chalmor.co.uk or call 01582 748700 for further support.

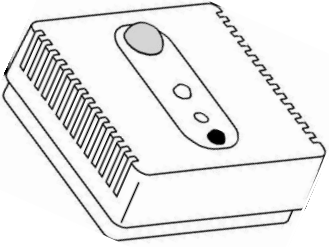

1 Introduction ▲

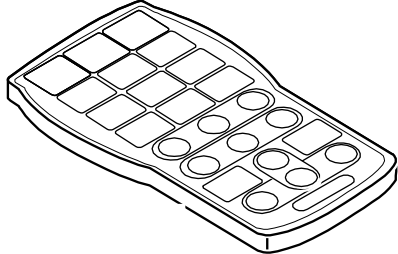
This manual explains how to install, use and maintain the PAIR timer. Please keep this manual in a safe place so you can refer to it in the future if you need to.

The box should contain the following items and accessories.

<p>PAIR parts</p>	<p>Remote control (if you ordered one)</p>
<p></p> <p> Plug  Plug (spare)</p>	<p></p>
<p>PAIR timer</p> <p></p> <p>Two AA (LR6) batteries</p>	<p></p> <p>Remote control CR2025 battery (already in the remote control)</p>
<p></p> <p>Instructions</p>	

You will need:

- a Phillips screwdriver (one with a cross tip)
- a hand drill or battery powered drill
- two raw plugs or fixings to suit the surface that the PAIR timer will be fitted to
- two screws to fix the PAIR timer or a self adhesive bonding system; and
- a pen or pencil to record the PAIR settings.

You may need:

- a remote control (to set the PAIR timer, unless the default settings suit you)
- glue tack (to temporarily hold the PAIR timer in place while you test the sensor coverage and range before fitting permanently)
- suitable step ladders or a podium / platform to allow you to reach the wall or ceiling where the PAIR timer will be fitted.

2 General use ▲

Each PAIR timer sends signals to an eTRV electronic thermostatic radiator valve to regulate the heating in the room, based on occupancy detected within the area. A remote control and LED indicator (a red, yellow or green light) allow you to programme and use the PAIR easily. Using the PAIR improves your comfort and saves energy.

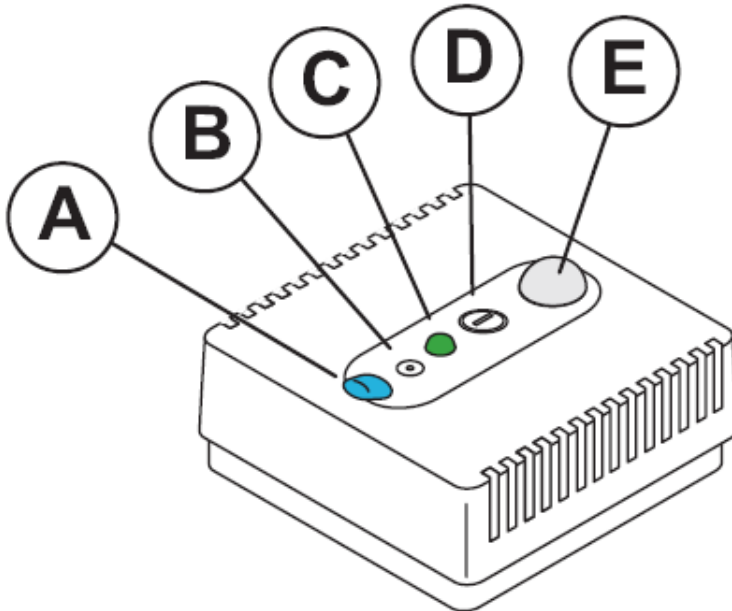

A: Transmitter
B: Receiver
C: LED indicator

D: Screw hole and plug
E: PIR sensor

3 Getting started ▲

Step 1

Remove the screw holding the cover to the base. Set it aside to secure the cover later.

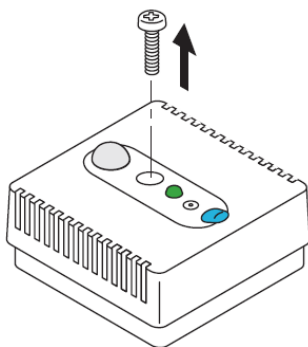

Step 1 – remove the screw

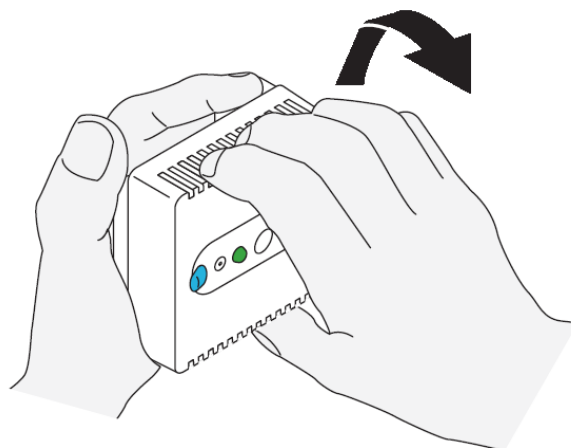

Step 2 - remove the cover

Step 2

Remove the cover from the base by gently squeezing the housing. To release the cover from the base, ease the cover off, taking care not to snap the plastic hooks on the base.

3a Fitting the batteries to the PAIR timer ▲

Insert the two AA (LR6) alkaline batteries provided with the PAIR timer into the battery holder as shown. Make sure you put the batteries in the right way. Inside the cover there is a label with a diagram showing which way to fit the batteries, when looking in to the PAIR timer cover.

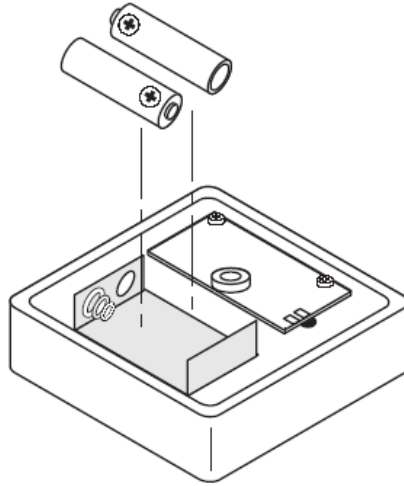

Important

- **Different manufacturing batches of PAIR timers may use different battery holders.**
- **If the PAIR timer has a front loading battery holder, simply push the batteries in to the holder. Spin the battery closest to the ventilation slots so that the black print faces the outer edge, leaving the battery less visible from outside.**
- **If the PAIR timer has a side loading battery holder, release the battery holder from its' normal position by pulling the holder gently apart from the cover. The side loading battery holder is secured using a hook and loop pad.**
- **Push the batteries in to the holder and re-attach the battery holder to the cover with the hook and loop pad. Spin the battery closest to the vents so that the black print faces the outer edge, making the battery less visible from outside.**
- **Take care to ensure the cable that connects the battery holder to the printed circuit board is neatly folded away, so that it will not become trapped between the base and the cover when re-assembled, and that it does not lie around the central screw hole where it could be damaged by the plastic boss or screw.**
- **Take care to not allow the connecting cable to become strained or the insulation damaged.**
- **Some models of PAIR timer may instead be provided with a terminal strip to connect a 12V DC external power supply, where batteries aren't required. In that case, refer to the instructions from the controller providing the power supply for the correct connection and wiring method.**

When the batteries are fitted, the PAIR timer will go in to a standby mode for a minute and the LED will give a yellow indication until the sensor has stabilised.

PAIR timer in standby mode Yellow light on for one minute	 on for 1 minute
--	---

Once the yellow light has switched off, it is then possible to use the PAIR timer.

3b Fitting the batteries to the remote control ▲

Remote control battery

Pull the plastic tab out of the battery-compartment. There is already a battery in the remote control. But for future reference, below we explain how to replace the battery.

Step 1

Push the clip, which has a hole in it, to the right.

Step 2

Pull out the battery holder.

Step 3

Pull out the CR2025 battery and replace it with a new one, with the side showing the positive (+) symbol facing upwards.

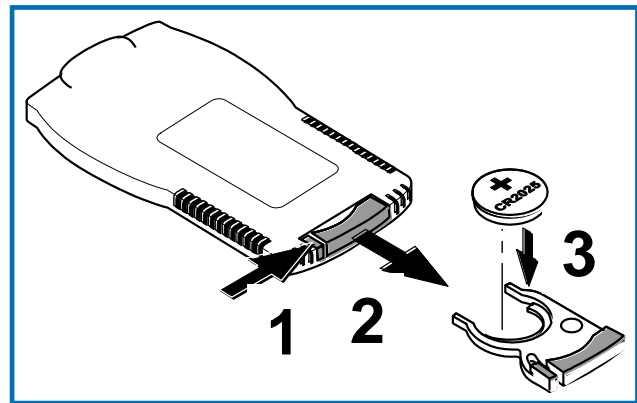

Step 4

Push the battery holder back into remote control.

Tip – if the remote control has not been used for a long time or stops working, try opening the battery compartment for a few seconds, closing it again will restart the remote control.

3c Using the remote control for testing the PAIR timer ▲

The PAIR timer will automatically go in to walk test mode for ten minutes after the batteries are fitted.

You can re-start and cancel the walk test mode using the remote control. See page 19 if you need to do this.

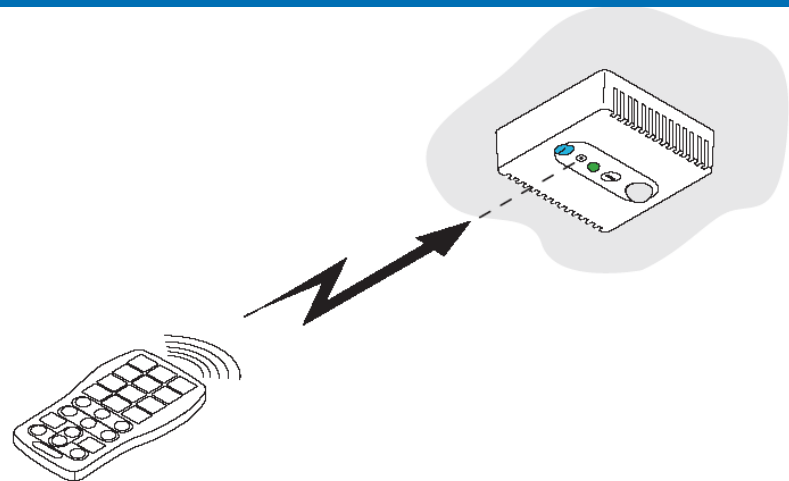

3d Finding the best place for the PAIR timer ▲

In most cases, the PAIR timer will be fitted to a ceiling in line with the eTRV that it is sending signals to.

It is also possible to fit the PAIR timer on the wall, generally at high level opposite the eTRV that it is sending signals to.

It is essential that the transmitter has direct line of sight to the eTRV, and the transmitter on the PAIR timer must be pointing directly at the eTRV.

Tip – when ceiling mounted, the PAIR timer will generally be located between 500mm and 1500mm away from the eTRV that it is signalling.

The infrared receiver at the top of the eTRV must be directed towards the PAIR timer so that it can receive the signals from the transmitter. Therefore, the eTRV should be rotated to face towards the PAIR timer.

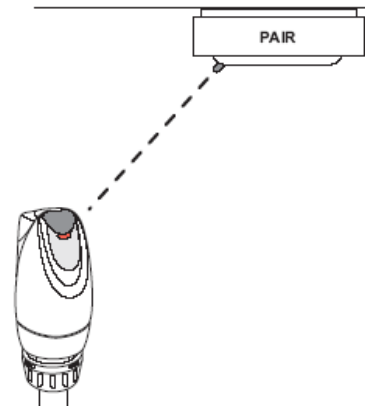

Dotted line shows the PAIR transmitter pointing directly to the eTRV receiver

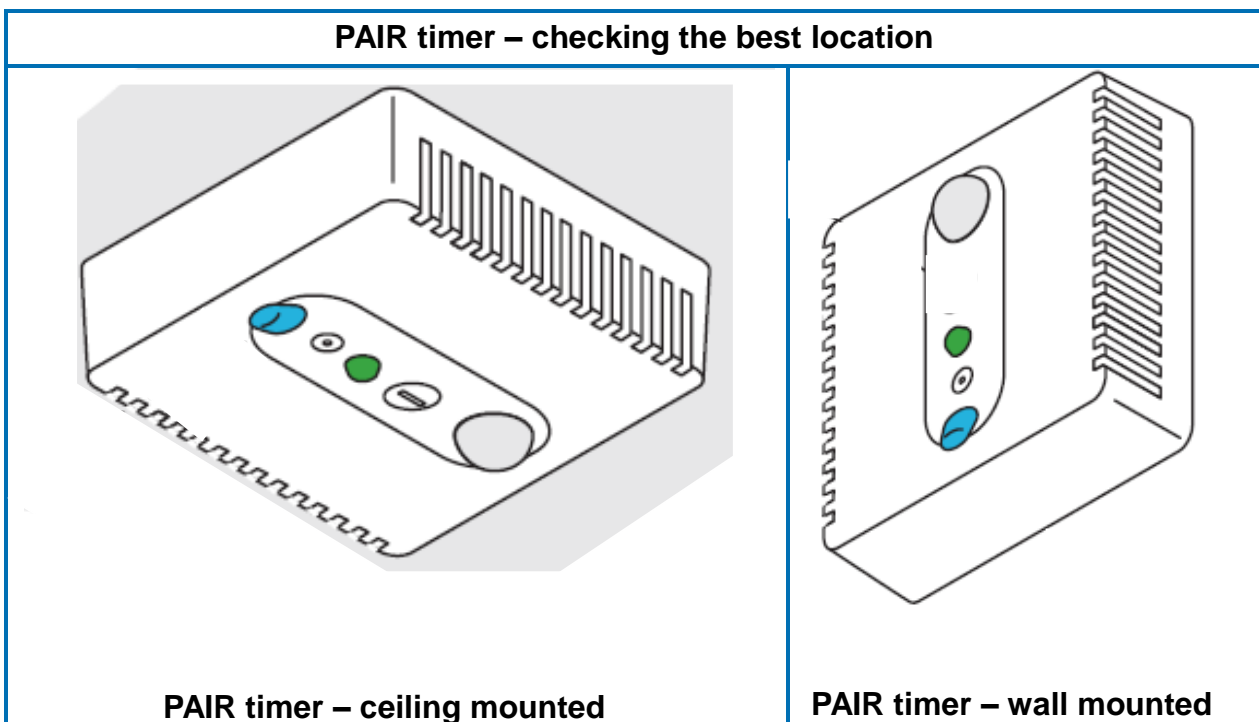

When the batteries are fitted, the PAIR timer will go in to a standby mode for a minute and the LED will give a yellow indication until the sensor has stabilised. Then, the sensor will go in to a walk test mode for 10 minutes.

Whilst in walk test mode, the LED will flash red for 2 seconds whenever movement is detected. At the same time, the PAIR timer sends a signal to the eTRV. When the eTRV sees the signal, the LED on the eTRV will flash red, yellow, green and again red, yellow, green. Follow the steps on page 10 overleaf.

3e Walk test the sensor and check the link to the eTRV ▲

Step 1

Refer to the drawings on the back cover and then temporarily secure the PAIR timer in the place you may like to fix it, where the transmitter will have direct sight of the eTRV and where the sensor has good coverage for seeing movement in the room. Hold in position and fix using glue tack capable of carrying the weight of the PAIR timer, taking care not to leave any dirty marks on the fixing surface or any glue tack residue on the PAIR timer.

Step 2



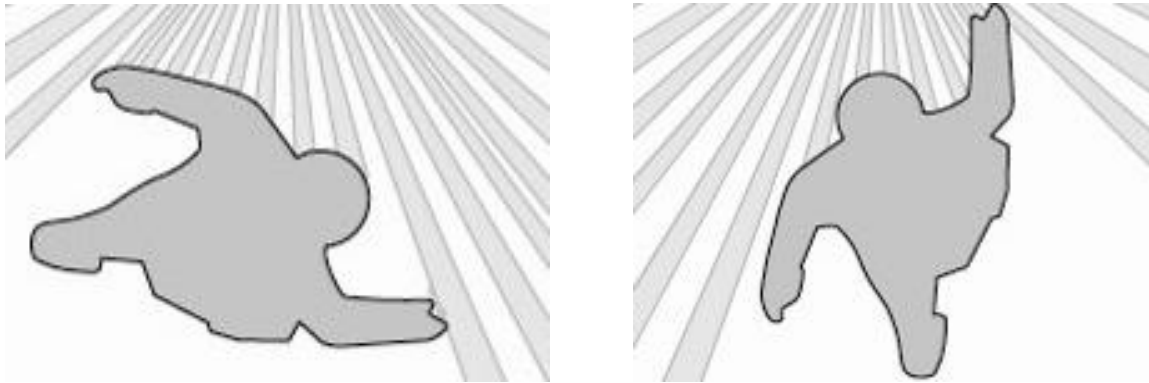



Walk around the room; keep an eye on the PAIR timer which will flash red when it sees your movement. Ensure there is good coverage around the room. Think about locations of furnishings and where people may generally enter the room or move within the room.



PAIR timer seeing movement: Red light on for two seconds	 on for 2 seconds on PAIR timer
---	--

Step 3

Move again so that the sensor sees your movement. This time, keep an eye on the LED on the eTRV. The LED on the eTRV will show two traffic light sequences made of six flashes, red, yellow, green twice whenever a signal is received from the PAIR transmitter. Check that furnishings and curtains will not obscure the line of sight between the transmitter and the eTRV. Look at the seating locations to ensure the people using the room won't block the signal, and that open doors won't restrict the sensor coverage or block the signal between the transmitter and the eTRV receiver.

eTRV seeing signal from transmitter: Six flashes, red, yellow, green X 2	      on eTRV
---	---

Reposition the PAIR timer if required until it shows a reliable link to the eTRV and good detection of movement around the room. Repeat steps 1, 2 and 3 until a satisfactory location has been established. You may need to rotate the eTRV too.

Note

The position of the person moving around the room could block the infrared signal. The transmitter sends the signal again after 210 seconds and after 420 seconds. Therefore if the person has moved away the repeat signal is unlikely to be blocked.

4 Fitting the PAIR timer ▲

Having chosen the best position to fit the PAIR timer, you are ready to attach the PAIR timer to the ceiling or wall. Mark the surface with the chosen location.

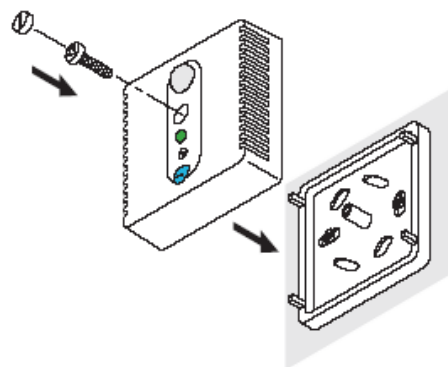

Remove any glue tack used for testing. If wall mounting the timer, take care to rotate the base so that the plastic clips are on the left and right sides (not top and bottom) of the base. For wall mounting the PIR dome sensor will be located at the top and the infrared transmitter at the bottom.

Considering the orientation required for the PAIR timer, ensure that the base is correctly rotated so that the plastic clips line up with the ventilation slots when the cover is fitted. Before marking the fixing hole positions through the base, take care to consider any pipes or cables that may be concealed beneath the surface. Then if required drill the holes and fix the raw plugs or fixings and using two screws or bonding system, attach the base to the ceiling or wall.

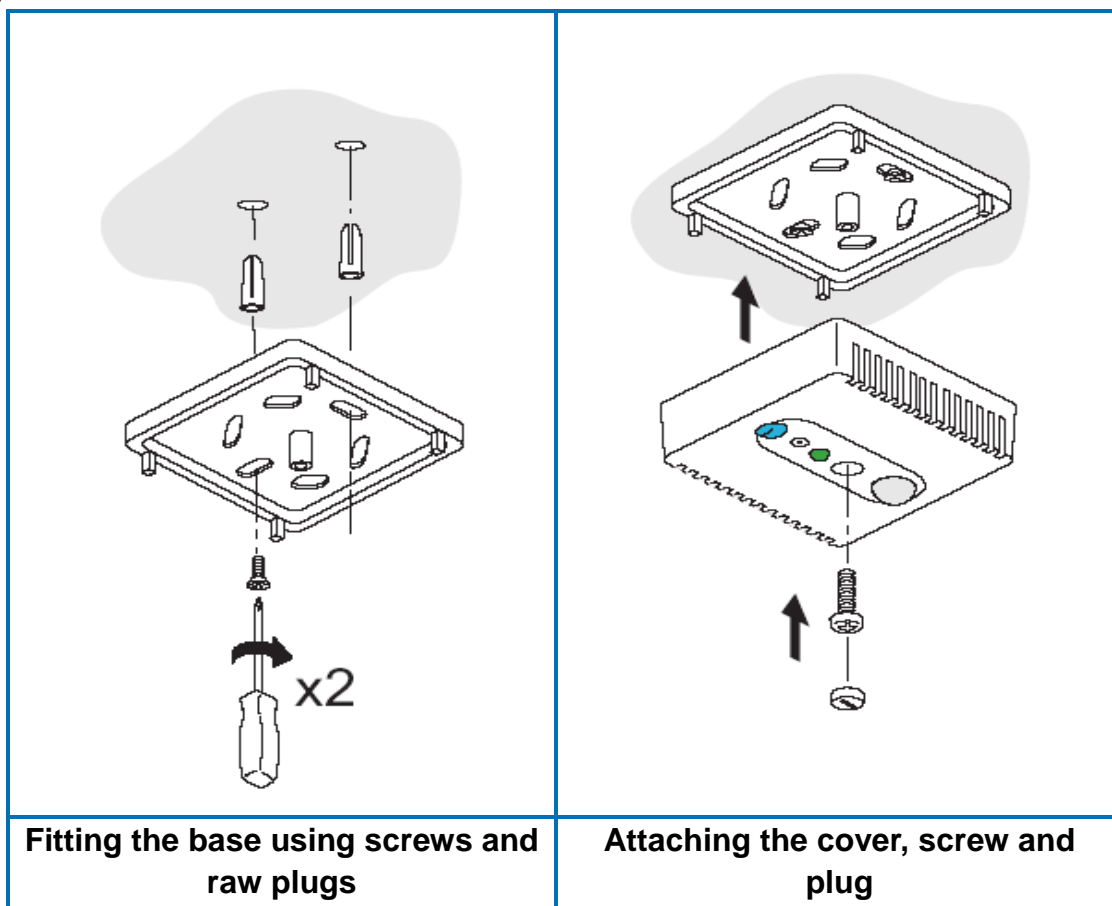

If there is a spare plug, leave it inside the cover or keep it in a safe place for use in the future, for example after the batteries are changed. Carefully attach the cover to the base, lining up the base clips with the ventilation slots that they will locate on to. Clip the cover onto the base and then fit the screw. Line up the slot in the plug with the groove in the cover. Then use a clean finger to push the plug in to seal off the screw hole.

5 Factory settings ▲

Your PAIR timer comes with default control settings stored in its memory. It will work to these settings until you change them.

5a What the LED indicator means ▲

The LED indicator flashes red, yellow or green to tell you what the PAIR timer is doing and its setting.

	Lights	Meaning
1	● Red light flashes once every five seconds	Dead battery needs replacing (see 5b below)
2	●● Red light flashes twice every five seconds	Low battery needs replacing (see 5b below)
3	● Red light flashes for 2 seconds	Sensor is in walk test mode and is detecting movement
4	● Green light constantly on	PAIR is waiting for instructions after 'SET' or '?' on the remote control has been pressed (times out after 1 minute)
5	●● Both green and yellow lights flash on at the same time	Button pressed correctly, waiting for another press
6	●●● Red, yellow and green lights flash on at the same time	OK - instructions have been given correctly
7	●●● Three red lights flash at the same time after trying to change a setting	Error - instructions given are not correct
8	●●● Red, yellow and green lights flash, at the same time, twice	PAIR sensor has been reset
9	●● Two red lights flash at the same time after trying to change a setting	PAIR sensor is locked (see section 8c on page 22)
10	●● Two green lights flash at the same time	PAIR sensor is unlocked (see section 8c on page 22)
11	● Yellow light constantly on	PAIR sensor in standby mode (following insertion or change of batteries this will last for up to 1 minute)

5b Replacing low and dead batteries ▲

Low battery ●●

When the batteries are low, the red LED light will flash twice every five seconds. At this point you should replace the batteries. When you replace the batteries at this stage, all the settings will be stored so you will not have to reset them. To change the batteries, see section 3a on page 7.

Dead battery ●

When the battery does not have enough charge to power the PAIR timer, the red LED light will flash once every five seconds. At this point, the PAIR timer will automatically send out the Low Battery mode setting to the eTRV which the eTRV will control to until the PAIR timer batteries are exchanged.

6 Using your PAIR timer ▲

You can use the PAIR timer with the default settings, or you can apply your own settings by using the remote control.

6a Default settings ▲

Without making any changes to the PAIR timer settings, the PAIR timer can work using its' default settings. The default settings allow the PAIR timer to:

- Operate the eTRV in ECO mode when the area is occupied;
- Operate the eTRV in LOW mode when the area is unoccupied;
- After 1 hour without movement detection, change from occupied to unoccupied mode;
- Operate with Sensitivity Setting of 2, medium sensitivity;
- Operate the eTRV in LOW mode when the PAIR batteries are dead.

6b Using the remote control to adjust the PAIR timer settings ▲

You can use the remote control to operate the PAIR timer and to check the settings. To use the remote control, simply point it at the infrared receiver on the front of the PAIR timer.

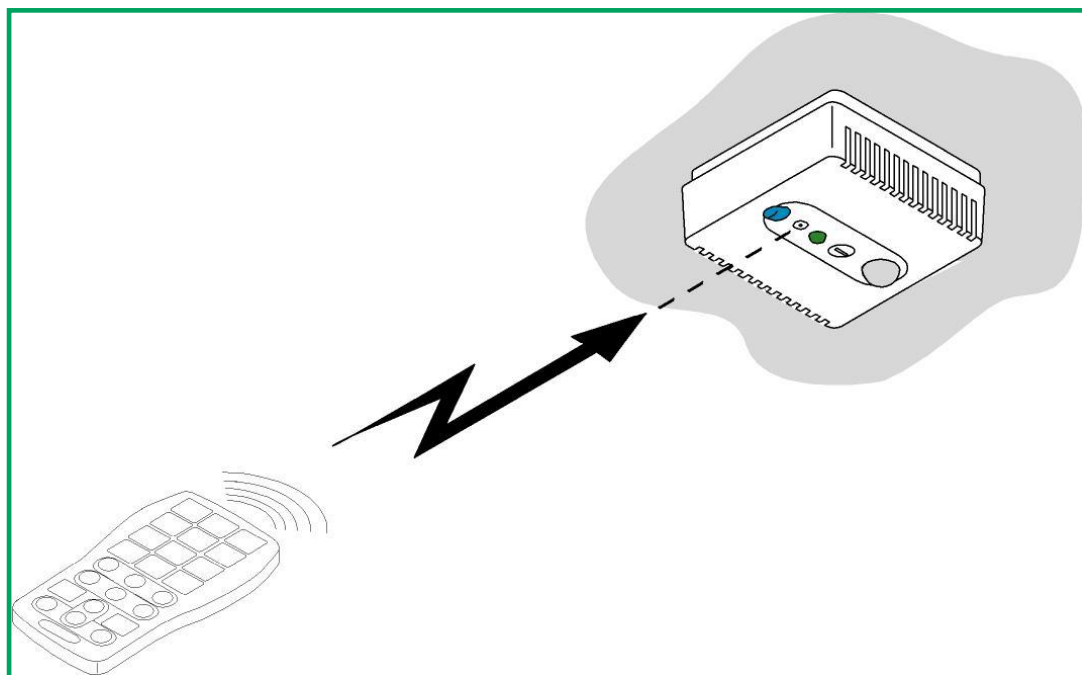

Firmly press the buttons on the remote control. The LED indicator on the PAIR timer will flash when it receives the signal from the remote control.

Note

The remote control must be pointed directly at the infrared receiver, and must be no more than five to six metres away from it. Take care to ensure that the eTRV doesn't receive signals intended for the PAIR timer.

7 Choosing your PAIR timer settings ▲

You can choose your PAIR timer settings according to how you want the heating to be controlled when the area is occupied or unoccupied, or left unused for a longer time.

You can choose a suitable temperature mode setting according to the occupancy of the area, and choose the timer delays (how long to wait) before the heating modes are changed. You can also choose what mode the heating is controlled to when the PAIR timer batteries die.

You are able to adjust the sensitivity level for the PIR occupancy sensor (including turning the PAIR off if it's not to be used) and you can lock all the settings to prevent them being unintentionally changed.

The settings available for each PAIR timer are shown in the table below, and the picture shows the remote control handset which is used to change the settings. Instead of the remote control handset, it is also possible to use an iLink on a suitable iPad, iPhone or iTouch (one with a 30 pin connector) or a Samsung Galaxy S4 or similar Android device with a built in Infrared transmitter, or a Universal remote controller.

You can plan and then record the settings you use in the “**Set to**” column in the table:

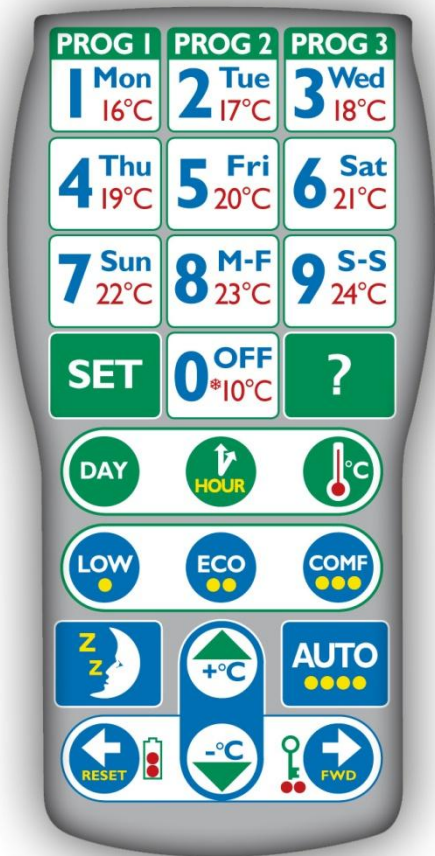

Description	Name	Set to	Choice
Temperature mode when occupied	Occupied mode		OFF
Temperature mode when unoccupied	Unoccupied mode		LOW
Temperature mode when left unused	Sleep mode		ECO
Temperature mode when batteries die	Low battery mode		COMF AUTO
Time to wait before using Unoccupied mode	Occupancy timer		1 hour to 99 hours (0 : walk test)
Time to wait before using Sleep mode	Sleep timer		1 hour to 99 hours (0 : disable)
Lock PAIR timer settings	Lock		LOCK or UNLOCK
PIR sensor sensitivity setting	Sensitivity Setting		1 : Low 2 : Medium 3 : High 0 : Turns PAIR off

Note : Please refer to the eTRV manual for further information on temperature settings.

7a Occupancy Mode Settings ▲

The PAIR timer will allow you to choose from any of the following temperature modes:



These mode settings can be selected independently for each of the following conditions:

Occupied mode	(pre-set to ECO)
Unoccupied mode	(pre-set to LOW)
Sleep mode	(pre-set to OFF)
Low battery mode	(pre-set to LOW)

According to the occupancy status of the room, the PAIR timer switches your eTRV to control to the stored temperature setting for the chosen temperature mode. It will then stay in that mode until the occupancy status of the room changes.

You can adjust the temperature settings for each temperature mode (which is explained in the eTRV user instructions in section 9a on page 17). The default eTRV temperature mode settings are:



OFF – the eTRV goes to the “off” temperature setting (pre-set to 10°C)



LOW – the eTRV goes to the “low” temperature setting (pre-set to 17°C)



ECO – the eTRV goes to the “economy” temperature setting (pre-set to 19°C)



COMF – the eTRV goes to the “comfort” temperature setting (pre-set to 21°C)



AUTO – the eTRV goes to the “automatic” programme (if one has been selected) which will vary the heating time and temperature settings according to the day, time and temperature mode selected in the programme

When the eTRV receives the new mode from the PAIR timer, the LED indicator on the eTRV will flash red, yellow and green to confirm the change of setting.

7b Changing the Occupancy Mode Settings ▲

You can change the temperature setting for each of the following occupancy modes:

Occupied mode
Unoccupied mode
Sleep mode
Low battery mode

When you have changed the occupancy mode setting, the LED indicator on the PAIR timer will flash red, yellow then green to confirm that the setting has changed.

Examples

- If you want to change the OCCUPIED mode setting to COMFORT then press:

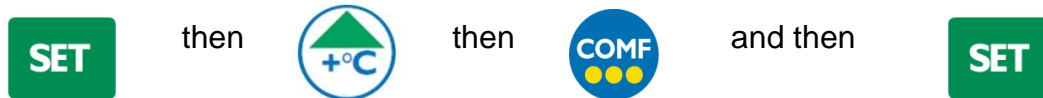

- If you want to change the UNOCCUPIED mode setting to ECO then press:



- If you want to change the SLEEP mode setting to LOW then press:



- If you want to change the LOW BATTERY mode setting to OFF then press:



- If you want to change the LOW BATTERY mode setting to AUTO then press:



Consider using the AUTO mode to run a pre-defined heating programme (set on the eTRV) when the PAIR batteries are dead. Or think about setting a suitable Low Battery mode so that in the event of the PAIR batteries not being changed, the ECO temperature mode could for example provide heating so occupants are not left cold. Or think about setting a LOW temperature mode or even selecting the OFF temperature mode to trigger a user complaint so that batteries are changed.

7c Checking the Occupancy Mode Settings ▲

The PAIR timer can confirm the Occupancy Mode settings by using the  button on the remote control and then the appropriate occupancy mode button.

Examples

To find out the OCCUPIED mode setting, press:



To find out the UNOCCUPIED mode setting, press:

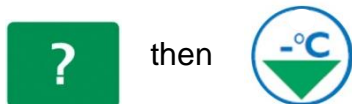











To find out the SLEEP mode setting, press:



To find out the LOW BATTERY mode setting, press:



The yellow LED indicator light on the PAIR timer flashes to show the set temperature mode (which corresponds with the yellow dots shown on the remote control handset buttons):

	Lights	Meaning	Remote control symbol
0	 Yellow light flashes for 2 seconds	OFF mode set	
1	 Yellow light flashes once	LOW mode set	
2	 Yellow light flashes twice	ECO mode set	
3	 Yellow light flashes three times	COMF mode set	
4	 Yellow light flashes four times	AUTO mode set	

7d Occupancy and Sleep Timer Settings ▲

The PAIR timer will allow you to choose time delays from 1 hour to 99 hours. These PAIR timer settings can be selected independently for each of the following conditions:

Occupancy Timer	(pre-set to 1 hour)
Sleep Timer	(pre-set to 0 : disabled)

Following detection of movement, the PAIR timer immediately sends a signal to the eTRV to operate at the Occupied temperature mode. So long as movement continues, the Occupied temperature mode will continue to be used.

If no movement is detected, then after waiting for the time set on the **Occupancy Timer** (default 1 hour, maximum 99 hours), the PAIR timer sends a signal to the eTRV to operate at the Unoccupied temperature mode.

If there continues to be no movement detected, then after waiting for the time set on the **Sleep Timer** (default is 0 hours so the sleep mode is disabled, maximum is 99 hours), the PAIR timer sends a signal to the eTRV to operate at the Sleep temperature mode.

If at any time movement is detected when in Unoccupied temperature mode or Sleep temperature mode, then the PAIR timer immediately sends a signal to the eTRV to operate at the Occupied temperature mode again.

When the eTRV receives the new temperature mode from the PAIR timer, the LED indicator on the eTRV will flash red, yellow and green to confirm the change of setting.

Illustrated below, the room is occupied from 6am to 8am and again from 5pm to 6pm. The Occupancy Timer is set to 1 hour and the Sleep Timer is set to 4 hours. The temperature modes are set to default settings of ECO (Occupied), LOW (Unoccupied) and OFF (Sleep).

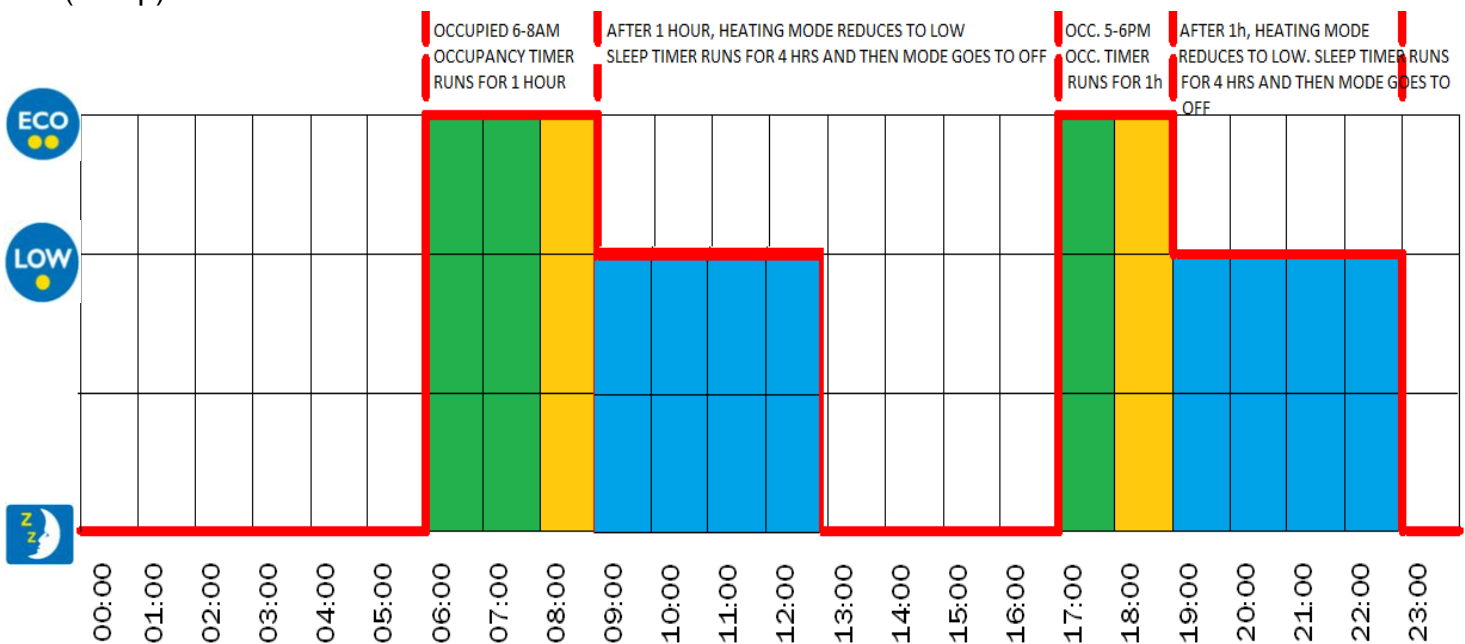

7e Changing the Occupancy and Sleep Timer Settings ▲

You can change the PAIR timer setting for each of the following:

Occupancy Timer	(pre-set to 1 hour)	Maximum setting is 99 hours
Sleep Timer	(pre-set to 0 : disabled)	Maximum setting is 99 hours

When you have changed the occupancy timer setting or changed the sleep timer setting, the LED indicator on the PAIR timer will flash red, yellow then green to confirm that the setting has changed.

Examples

- If you want to change the OCCUPANCY timer setting to 3 hours then press:

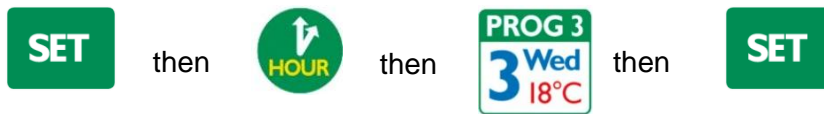

- If you want to change the SLEEP timer setting to 10 hours then press:



The LED indicator will flash red, yellow then green to confirm the change of setting.

- If you want to change the OCCUPANCY timer setting to start the walk test again for another 10 minutes then press:

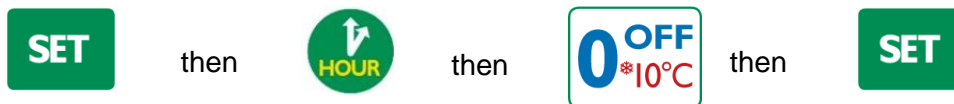

The LED indicator will flash red, yellow then green to confirm the change of setting. After 10 minutes when the walk test mode finishes, the LED indicator will flash red, yellow then green again to show that the walk test time has finished and the red LED will stop flashing.

Note : Remember to adjust the OCCUPANCY timer to the required setting after you have completed the walk test. If you don't adjust the OCCUPANCY timer, after the 10 minutes walk test period has finished it will automatically revert to the last setting.

- If you want to disable the SLEEP mode then change the SLEEP timer setting to 0 hours:



The LED indicator will flash red, yellow then green to confirm the change of setting.

7f Checking the Occupancy and Sleep Timer Settings ▲

The PAIR timer can confirm the Occupancy and Sleep timer settings by using the ? button on the remote control and then the timer button.

Example

To find out the OCCUPANCY timer setting and the SLEEP timer setting, press:



then









The green LED indicator light on the PAIR timer flashes first to show the occupancy timer setting. The red LED indicator light on the PAIR timer flashes next to show the sleep timer setting.

The green LED light will flash a number of times to show two figures for the occupancy timer setting in hours (hh), with a two-second pause between flashes. If the figure is '0', the light will stay on for two seconds.

The red LED light will flash a number of times to show two figures for the sleep timer setting in hours (hh), with a two-second pause between flashes. If the figure is '0', the light will stay on for two seconds.

For example, **03 hours** for the Occupancy timer setting and **10 hours** for the Sleep timer setting would be as follows.

Green light on for two seconds		= 0
Two-second pause		
Three green flashes		= 3
Two-second pause		
One red flash		= 1
Two-second pause		
Red light on for two seconds		= 0

Note : When in walk test mode, the Occupancy timer setting will show its' last setting, which is the setting that it will revert to at the end of the 10 minute Walk Test.

8 Extra settings ▲

The PAIR time has the following extra settings.

8a Adjusting the sensitivity setting of the PIR occupancy sensor ▲

You can adjust the Sensitivity Setting (S-S) of the PIR occupancy sensor between Low (1), Medium (2) or High sensitivity (3). The default sensitivity setting is Medium (2). You are also able to turn the sensitivity setting to Off (0) which will stop the PAIR timer from sending commands to the eTRV.

For normal operation, sensitivity setting 2 will apply. If there is evidence of false triggering of the occupancy sensor, for example as a result of warm air currents triggering the occupancy sensor, then the sensitivity setting can be reduced.

To reduce the Sensitivity Setting to Low (1), press the following buttons.



If there is evidence of poor response, for example where people in the room are not triggering the occupancy sensor, then the sensitivity setting can be increased.

To increase the Sensitivity Setting to High (3), press the following buttons.



If there is a need to switch the occupancy sensor off, for example when automatic adjustment of the heating mode is no longer required, then the sensitivity setting can be adjusted to 0 (off). This may be useful where a resident has mobility issues and permanent heating may be required, regardless of movement within the room.

To adjust the Sensitivity Setting to Off (0), press the following buttons.



The LED indicator will flash red, yellow then green to confirm the change of setting.

Note : When in Walk Test mode, if the Sensitivity Setting is set to 0 (off) the Walk Test LED will not operate. When adjusting the Sensitivity Setting during the 10 minute Walk Test period, it will be necessary to re-start the Walk Test mode following any adjustment of the Sensitivity Setting.

8b Checking the sensitivity setting of the PIR occupancy sensor ▲

To check the sensitivity setting of the PIR occupancy sensor, press the following buttons.



The green LED light will flash a number of times to show the relevant sensitivity setting, as shown in the table opposite.

Number of flashes	Sensitivity Setting
Light on for two seconds	0 = Off
One flash	1 = Low
Two flashes	2 = Medium
Three flashes	3 = High

8c Lock settings ▲

You can lock the PAIR timer so that settings can't be inadvertently changed, for example so remote control signals intended for the eTRV don't affect the PAIR timer settings.

To lock the PAIR timer, press the following buttons.

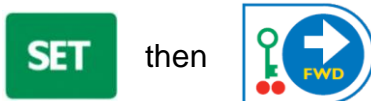

The red LED light will flash twice to show that the PAIR timer is now locked. The following table shows the settings and functions that will be locked and those that are still available.

Locked features	<ul style="list-style-type: none"> • Setting the Occupied mode • Setting the Unoccupied mode • Setting the Sleep mode • Setting the Low Battery mode • Setting the Occupancy Timer • Setting the Sleep Timer • Setting the Sensitivity Setting
Available features	<ul style="list-style-type: none"> • Unlocking • Restoring factory settings • Checking features (?)

To unlock the PAIR timer, press the following buttons.

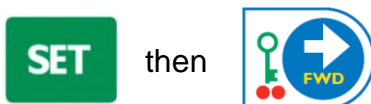

The green LED light will flash twice to show that the PAIR timer is unlocked.

Note : If the PAIR timer does not unlock, it is possible that a secure lock may be in use.

To check if the PAIR timer is locked, press the following buttons.



The red LED light will flash twice to show that the PAIR timer is locked or the green LED light will flash twice to show that the PAIR timer is unlocked.

Note : If anyone tries to use a locked feature while the PAIR timer is locked, the red LED light will flash twice.

8d Restore factory settings ▲

To reset the PAIR timer to the settings that were originally stored in it, ensure that the PAIR timer is unlocked and then press the following buttons.



This will restore the setting of the modes and timers to those set at the factory. The LED indicator will flash red, yellow then green twice to confirm the change of setting.

Note

The PAIR timer will revert to Walk Test mode for 10 minutes, as if the batteries had just been fitted.

9 Technical properties ▲

CE This product complies with: BSEN 60730

PAIR Timer	
Controller type	Programmable
PIR range – when ceiling mounted at 2.5m, range at 0.7m above floor	7m x 1m beam diameter (Axis A) – <i>see drawings overleaf</i> 4m x 1m beam diameter (Axis B) <i>overleaf</i>
PIR range – wall mounted at 2.2m	110° fan, 3m to 7m range – <i>see drawings overleaf</i>
Active Infra Red transmitter Beam diameter – ceiling mounted	(x) = difference in height of PAIR timer & eTRV. PAIR approx 70% of (x) horizontally from eTRV. Beam diameter at eTRV approx (x) minus 0.5m.
Active Infra Red transmitter Beam diameter – wall mounted	(x) = difference in height of PAIR timer & eTRV. PAIR approx 150% of (x) horizontally from eTRV Beam diameter is approx (x) minus 0.1m.
Temperature range it can be stored in	-20°C to +60°C
Temperature range it will work in	+5°C to +40°C
Application group	Central Generation
Zone type	Maintained or Intermittent
Power supply	Two 1.5V AA alkaline batteries (LR6)
Battery life	Up to 2½ years (depending on use)
Back-up memory	Yes
Overall Size (HxWxD)	87mm high, 87mm wide, 40mm deep
Protection class	IP20
Remote control	
Temperature range it works in	-10°C to +50°C
Temperature range it can be stored in	-20°C to +60°C
Humidity range it can work in	0 to 90% RH
Range from PAIR it works in	Up to 7 metres
Power supply	One 3V CR2025 battery
Battery life	Three years (depending on use)
Size	115mm high, 58mm wide and 8mm high
Protection class	IP20

10 Drawings for PAIR timer location, sensor and beam coverage ▲

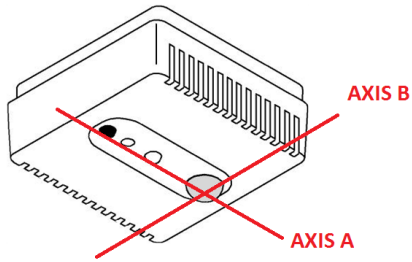

PAIR timer – ceiling mounted
(patterns based on ceiling height of 2.5m)

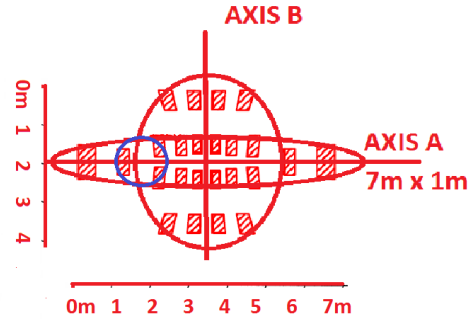

PIR beam patterns shown at 0.7m above floor level (desk level)
Small circle shows Active Infra Red transmitter beam at 0.1m above floor level (example of eTRV level)

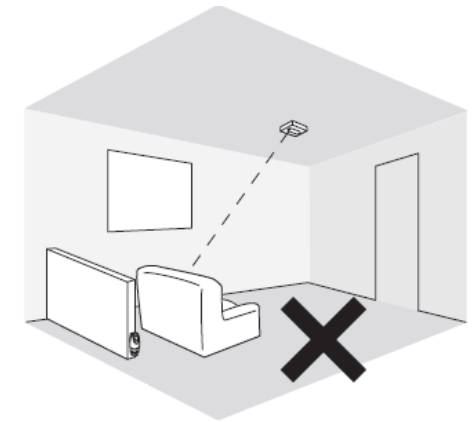
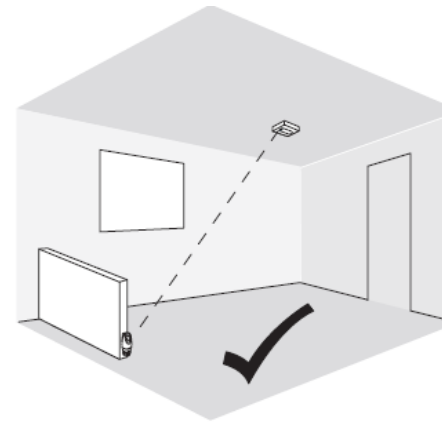

PAIR timer – ceiling mounted example showing correct position and incorrect position where furniture can block Active Infra Red transmitter beam

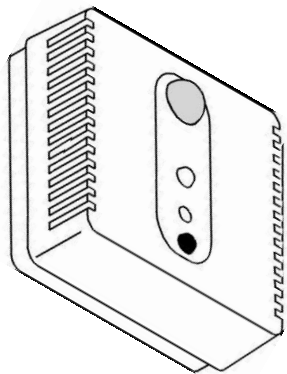

PAIR timer – wall mounted
(patterns based on wall mounting at height of 2.2m)

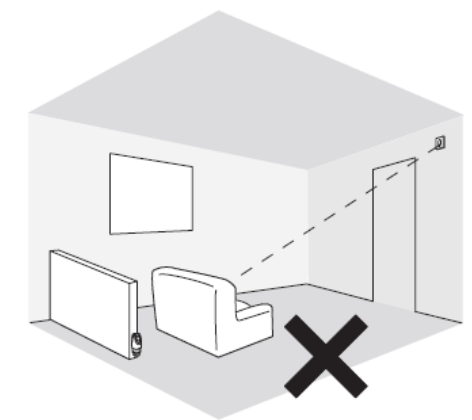
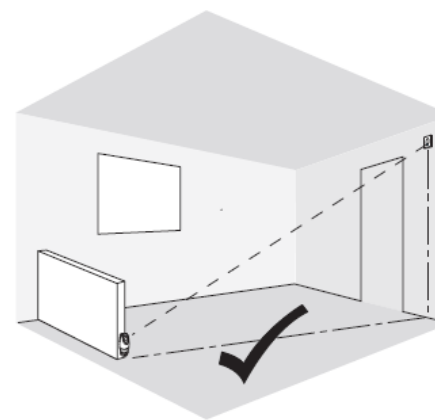
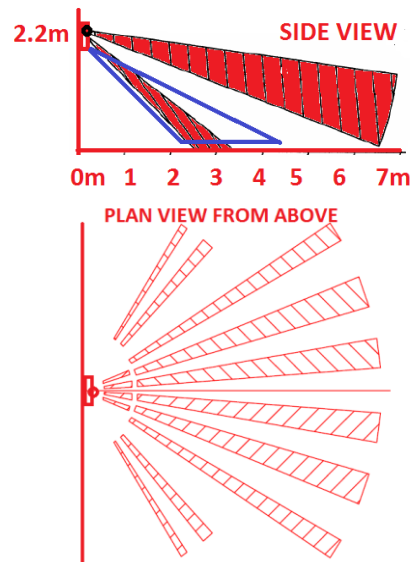

PAIR timer – wall mounted example showing correct position and incorrect position where furniture can block Active Infra Red transmitter beam