

M20

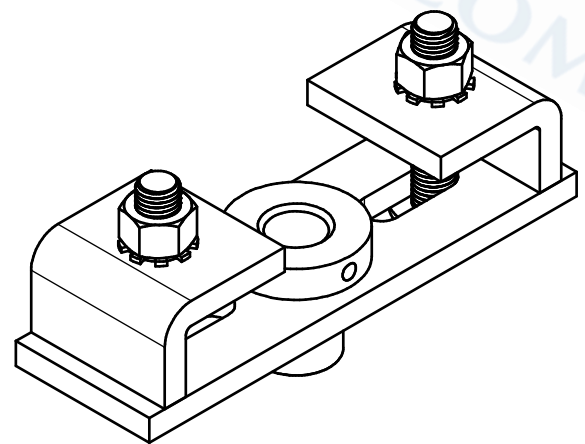

Support de fixation sous I
Matière: Acier

Fixing bracket for Ibeam
Material: Steel



7,rue Gay Lussac
25000 BESANCON

Référence
Item Nr: **8577**

Rail associé
Combined track: **8570**