



**CR3501A**  
**Fleetwood**  
**Instruction Manual**

---



Questions, problems, missing parts?  
Before returning to the store, call Customer Service  
8 a.m. – 6 p.m., EST, Monday – Friday  
1-888-CROSLEY  
[www.crosleyradio.com](http://www.crosleyradio.com)

## **Safety Instructions**

---

Read and understand this entire manual before using this product. Keep these instructions for future reference.

1. Do not use this product near water.
2. This product should be operated only by the type of power source indicated on the marking label or in this instruction manual.
3. Do not defeat the safety purpose of the polarized plug. A polarized plug has two blades with one blade wider than the other. This plug will fit into the power outlet only one way. If you are unable to insert the plug fully into the outlet try reversing the plug. If the plug should still fail to fit, contact your electrician.
4. Protect the power cord from being walked on or pinched particularly at plugs, convenience receptacles, and the point where they exit from the product.
5. Do not overload wall outlets, extension cords, or integral convenience receptacles as this can result in a risk of fire or electric shock.
6. Never push objects of any kind into this product through openings as they may touch dangerous voltage points or short-out parts that could result in a fire or electric shock. Never spill liquid of any kind on the product.
7. Do not attempt to service this product yourself as opening or removing covers may expose you to dangerous voltage or other hazards. Refer all servicing to qualified service personnel.
8. Changes or modifications to this unit not expressly approved by the party responsible for compliance could void the user's authority to operate the equipment.
9. Do not use attachments not recommended by the product manufacturer as they may cause hazards.
10. A product and cart combination should be moved with care. Quick stops, excessive force, and uneven surfaces may cause the product and cart combination to overturn.
11. Slots and openings in the cabinet are provided for ventilation and to ensure reliable operation of the product and to protect it from overheating. Do not block or cover these openings.
12. Unplug the product during lightning storm or when unused for long periods of time.

## Items in this package

---

Before throwing away any packaging materials, please check thoroughly and make sure you find the following items that come along with this package:

- Radio
- Remote Control
- Power cord
- 3.5mm aux in cable
- FM Wire Antenna

Please contact Crosley customer service if there is any accessory missing from the package. **Retain the original packaging materials for exchange or return purposes.**

## Specifications

---

Power Source	AC120V ~ 60 Hz
Power consumption	30W
Output Power	15W x 2
Frequency Range	FM 87.5 – 108.0 MHz
Frequency Response	45Hz – 20KHz
Audio Input Sensitivity	500mV
Dimension	366 x 115 x 232 mm

Note:

- *Design and specifications are subject to change without notice.*
- **To help save power consumption, some models will comply with ERP energy saving standard. When there is no audio input for 20 minutes, their powers will automatically cut-off. To turn power back on and resume playing, you will need to turn off the power and turn it on again.**

## Product Description

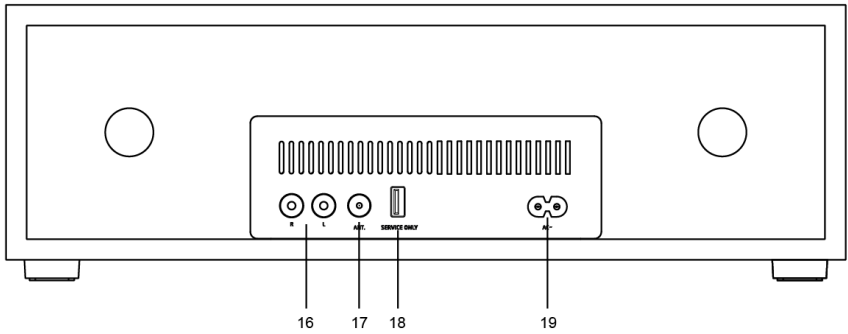
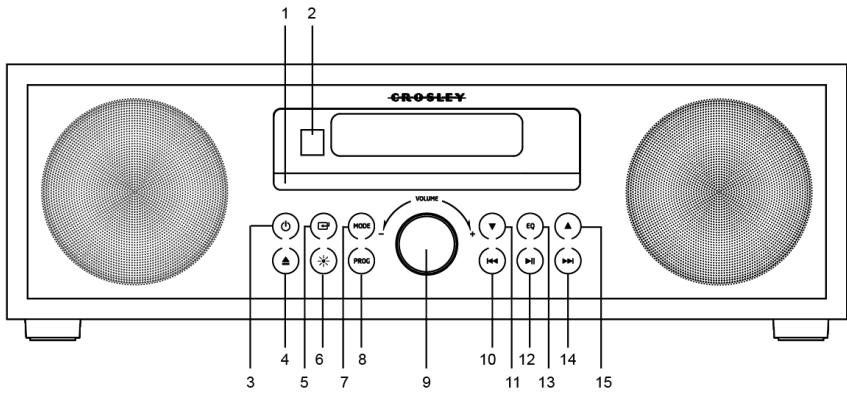

- |                          |                                 |
|--------------------------|---------------------------------|
| 1. CD Tray               | 11. Preset Down Button          |
| 2. Remote Control Sensor | 12. Play/Pause Button           |
| 3. Power Button          | 13. EQ Button                   |
| 4. Open/Close Button     | 14. Forward Skip Button         |
| 5. Function Button       | 15. Preset Up Button            |
| 6. Dimmer Button         | 16. RCA Jacks                   |
| 7. Mode Button           | 17. Antenna                     |
| 8. Program Button        | 18. USB Jack (for SERVICE ONLY) |
| 9. Volume Knob           | 19. Power Jack                  |
| 10. Backward Skip Button |                                 |

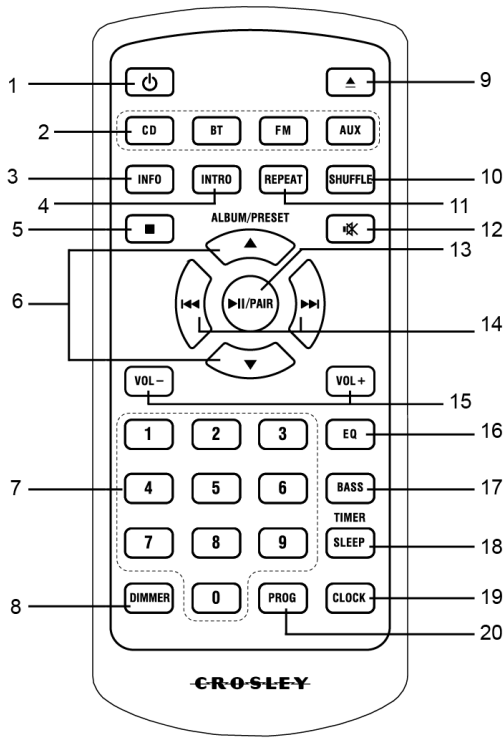

- 1. Power Button
- 2. Function Button
- 3. Info Button
- 4. Intro Button
- 5. Stop Button
- 6. Preset Buttons
- 7. Numeric Pad
- 8. Dimmer Button
- 9. Open/Close Button
- 10. Shuffle Button

- 11. Repeat Button
- 12. Mute Button
- 13. Play/Pause/Pair Button
- 14. Skip Button
- 15. Volume Button
- 16. EQ Button
- 17. Bass Button
- 18. Sleep Button
- 19. Clock Button
- 20. Program Button

## Initial Setup

---

### Essential Setup

1. Place the unit on a flat and level surface. The selected location should be stable and free from vibration.
2. Connect AC adaptor to the Power Jack of the unit.
3. Connect the supplied FM wire antenna to the ANT. socket on the unit.
4. Untie the FM Antenna and allow it to hang in a straight line.

## Remote Control

---

### Prepare the Remote Control

First-time use:

The unit has a pre-installed lithium CR2025 battery. Remove the protective tab to activate the remote control battery.

Replace the Remote Control Battery

1. Pull out the battery tray and remove the old battery.
2. Place a new CR2025 battery into the battery tray with correct polarity (+/-) as indicated.
3. Insert the battery tray back into the slot.

*Note:*

- *If the Remote Control is operated near other products which generate infrared rays, or if other remote control devices using infra-red rays are used near the unit, it may operate incorrectly. Conversely, the other products may operate incorrectly.*

## Clock Setup

---

### Set the Clock

Manually setting the clock can only be done in STANDBY mode.



1. In STANDBY mode, press and hold the CLOCK button on the remote control until the hour digits are flashing.
  - Press the ►|| button on the unit or the ►||PAIR button on the remote control to select 12/24 hour format.
2. Press the ◀◀/▶▶ buttons on the remote control or on the unit to adjust the hour digits while flashing. Press CLOCK button on the remote control to confirm, and then the minute digits will flash.
3. Press the ◀◀/▶▶ buttons on the remote control or on the unit to adjust the minute digits while flashing. Press the CLOCK button on the remote control to confirm.

## Setting the Alarm

---

1. In Standby mode, press and hold the Timer/Sleep button on the remote control until the hour digits flash on the display.
2. Press the **◀▶** buttons on the remote control or on the unit to adjust the hour digits, and then press the Timer/Sleep button on the remote control to confirm, the minute digits will flash on the display.
3. Press the **◀▶** buttons on the remote control or on the unit to adjust the minute digits, and then press the Timer/Sleep button on the remote control to confirm, the mode will flash on the display.
4. Press **◀▶** the buttons on the remote control or on the unit to select:
  - FM (to wake to your selected FM Radio Station)
  - BUZZER (to wake to a buzzer sound)
  - DISC (to wake to your disc music)
5. Press the Timer/Sleep button on the remote control to confirm, the display will show the volume level.
6. Press the **◀▶** buttons on the remote control or on the unit to adjust the volume, and press the Timer/Sleep button on the remote control to confirm.  
The display will show the current time and  will appear from the display.

### Activate and Deactivate the Alarm

- Press the Timer/Sleep button on the remote control to view the alarm settings or activate the alarm.
- To deactivate the alarm, press the Timer/Sleep two times. The  will disappear from the display on the front of the unit.
- To activate the alarm, press the Timer/Sleep two times. The  will show from the display on the front of the unit.

### Stop Alarm Ring

- When the alarm rings, press the **⏏** button on the remote control or on the unit. The alarm stops but the alarm settings remain.

## Radio Operation

---

### Tuning in a Station

Tune in radio stations automatically

- Press and hold the **◀▶** buttons, the frequency changes down or up automatically until a station is found.

Tune in radio stations manually

- Press the **◀▶** buttons repeatedly until you find the station you want.

*Note:*

- *The unit is equipped with a FM wire antenna. To FM improve reception, move the wire around until the reception is clear without interferences. Do not connect the wire to any additional antenna.*

### Auto Scan and Save Preset Station

1. Press the **FM** button on the main unit or press the **FM** button on the remote control to select FM mode.
2. Press and hold the **PROG** button on the remote control to activate automatic programming. All available stations are programmed in the order of waveband reception strength.

### Tune to a Preset Radio Station

- Press the PRESET buttons to select a preset that you want.

### Presetting Stations Manually

You can preset up to 30 FM stations.

1. Tune in the desired station, then press the PROG button.
2. Press the **▲/▼** or number (0-9) buttons to select the preset number.
3. Press the PROG button to store the station.
4. Repeat above steps 1 to 3 for each station you want to store in memory with a preset number.

### Set the Sleep Timer









1. Press the TIMER/SLEEP button on the remote control repeatedly to select your desired number of minutes. The number of minutes shown will display in this sequence:

SLEEP 90 ➡ SLEEP 60 ➡ SLEEP 30 ➡ SLEEP 15 ➡ SLEEP 00

2. Stop pressing the SLEEP button when your desired number of minutes is displayed. The sleep timer is now set.
  - Press the SLEEP button to view the remaining time before switch off.
  - To cancel the sleep timer, press the SLEEP button repeatedly until "SLEEP 00" shows on the display.



## CD Playback Operation

1. Press the  button on the main unit or press the **CD** button on the remote control to select CD mode.
2. Press the  button on the unit or remote to open the CD tray and put the CD in the tray with the labeled side facing up.
3. Press the  button again to close the tray. If it is a blank CD or an unrecognizable CD, it will show "NO DISC". Playback will start automatically.
4. During the playback, press the  button on the unit or the /PAIR button on the remote control to pause or resume play.
5. To skip to the next or previous track, press the /PAUSE buttons on the remote control or on the unit.
6. To search fast forward or backward a track, press and hold the  buttons on the remote control or on the unit correspondingly until you reach the desired time. Release the button and the playback will resume.
7. Press the  button if you want to completely stop playback.

### Intro Playback

1. Press the Intro button on the remote control.
2. The unit will play the first 10 seconds of each track.
3. Press the Intro button on the remote control again to resume normal playback.



### Random Playback

Press the Shuffle button on the remote control or the Mode button on the unit to switch Shuffle Mode. The selected mode will show on the display.





- SHUFFLE: Randomly play the song.  lights up.
- SHUF OFF: Shuffle turned off.

### Repeat Playback

Press the Repeat button repeatedly on the remote control or the Mode button on the unit to select Repeat play modes. The selected mode will show on the display.

- RPT ONE: Repeat current track.  blinks.
- RPT ALL: Repeat all tracks.  lights up.
- RPT OFF: Repeat turned off.



## Programmed Playback

1. Press the  button on the remote control.
2. Press the PROG button on the remote control or on the unit to enter Memory mode.
3. Press the number (0-9) buttons or /  buttons on the remote control or on the unit to select the track that you want to preset, then press PROG button to confirm.
4. Repeat step 3 to program more tracks.
5. Press the  button to playback program tracks.

Note:

- If you want to change the programmed files, press the  button two times to clear the current program files, display shows "PRG CLR"

## Bluetooth Operation

1. Press the  button on the main unit or press the BT button on the remote control. "NO BT" will show on the display if the unit is not paired to any Bluetooth device.
2. Select "CR3501A-WA" in the pairing list. On successful pairing, you will hear "Paired" from the unit, and the display panel shows "BT".
3. If you cannot find the unit, press and hold the /PAIR button on the remote control or the  button on the unit to be searchable. The display will show "PAIRING" and you will hear "Pairing" from the unit.

Note:

- Enter "0000" for the password if necessary
- Version 3.0

## Other Operation

### Select the Equalizer

Press the EQ button on the remote control or on the unit repeatedly to select:  
[Pop] - [Classic] - [Jazz] - [Rock] - [Flat]

### Adjust the Brightness

Press the Dimmer button on the remote control or the  button on the unit to select brightness level.

### Adjust the Bass

Press the Bass button on the remote control enable and disable the bass.

## Aux Input Connection

---

You can connect an audio device to this unit and play your music through its speakers. To do this, connect the 3.5mm auxiliary cable between your audio device and the Aux In Jack of this unit and press the  button on the main unit or press the AUX button on the remote control.

## Troubleshooting

---

### There is no power

- Power cord is not connected correctly.
- No power at the power outlet.

### CD does not play

- The CD is blank.
- The CD is placed on the tray incorrectly with the label side facing down.
- The CD has unsupported digital audio files like MP3 and similar types of format.
- The CD has too many scratches or dirty.

## **FCC Statements**

---

NOTE: This equipment has been tested and found to comply with the limits for a Class B digital device, pursuant to part 15 of the FCC Rules. These limits are designed to provide reasonable protection against harmful interference in a residential installation. This equipment generates uses and can radiate radio frequency energy and, if not installed and used in accordance with the instructions, may cause harmful interference to radio communications. However, there is no guarantee that interference will not occur in a particular installation. If this equipment does cause harmful interference to radio or television reception, which can be determined by turning the equipment off and on, the user is encouraged to try to correct the interference by one or more of the following measures:

- Reorient or relocate the receiving antenna.
- Increase the separation between the equipment and receiver.
- Connect the equipment into an outlet on a circuit different from that to which the receiver is connected.
- Consult the dealer or an experienced radio/TV technician for help.

Changes or modifications not expressly approved by the party responsible for compliance could void the user's authority to operate the equipment.

This device complies with Part 15 of the FCC Rules. Operation is subject to the following two conditions:

1. This device may not cause harmful interference, and
2. This device must accept any interference received, including interference that may cause undesired operation.