

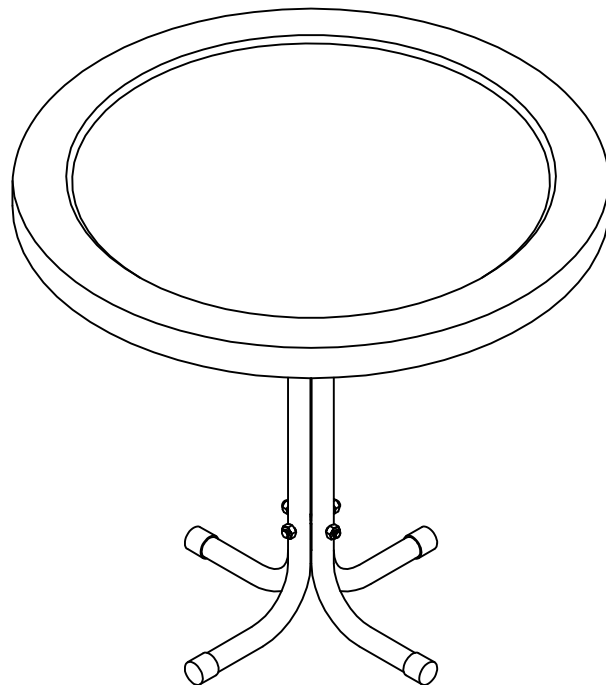







GRIFFITH METAL SIDE TABLE
CO1011A

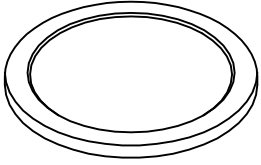

PART LIST

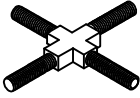
<div data-bbox="76 152 140 226" data-label="Text">1</div> 	<div data-bbox="443 152 507 226" data-label="Text">2</div> 
<div data-bbox="137 535 352 580" data-label="Text">Support Legs</div> <div data-bbox="169 624 320 674" data-label="Text">4 PCS</div>	<div data-bbox="533 535 700 580" data-label="Text">Table Top</div> <div data-bbox="564 624 676 674" data-label="Text">1 PC</div>

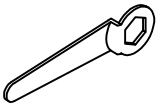
HARDWARE LIST

<div data-bbox="76 878 140 952" data-label="Text">A</div> 	<div data-bbox="443 878 507 952" data-label="Text">B</div> 	<div data-bbox="818 878 882 952" data-label="Text">C</div> 	<div data-bbox="1187 878 1251 952" data-label="Text">D</div> 
<div data-bbox="177 1256 312 1301" data-label="Text">"+"Bolts</div> <div data-bbox="169 1346 320 1395" data-label="Text">2 PCS</div>	<div data-bbox="576 1256 655 1301" data-label="Text">Nuts</div> <div data-bbox="533 1346 703 1395" data-label="Text">12 PCS</div>	<div data-bbox="911 1256 1062 1301" data-label="Text">Washers</div> <div data-bbox="903 1346 1074 1395" data-label="Text">12 PCS</div>	<div data-bbox="1294 1256 1430 1301" data-label="Text">Wrench</div> <div data-bbox="1302 1346 1422 1395" data-label="Text">1 PC</div>
<div data-bbox="76 1424 140 1498" data-label="Text">E</div> 	<div data-bbox="443 1424 507 1498" data-label="Text">F</div> 		
<div data-bbox="185 1794 312 1839" data-label="Text">Screws</div> <div data-bbox="169 1883 320 1933" data-label="Text">4 PCS</div>	<div data-bbox="528 1794 711 1839" data-label="Text">Tube Caps</div> <div data-bbox="536 1883 687 1933" data-label="Text">4 PCS</div>		

STEP 1 Attach the two Support Legs (1) using the 2 "+" bolts (A), 4 Washers (C) and 4 Nuts (B). Do not tighten until after you have completed the entire assembly process.

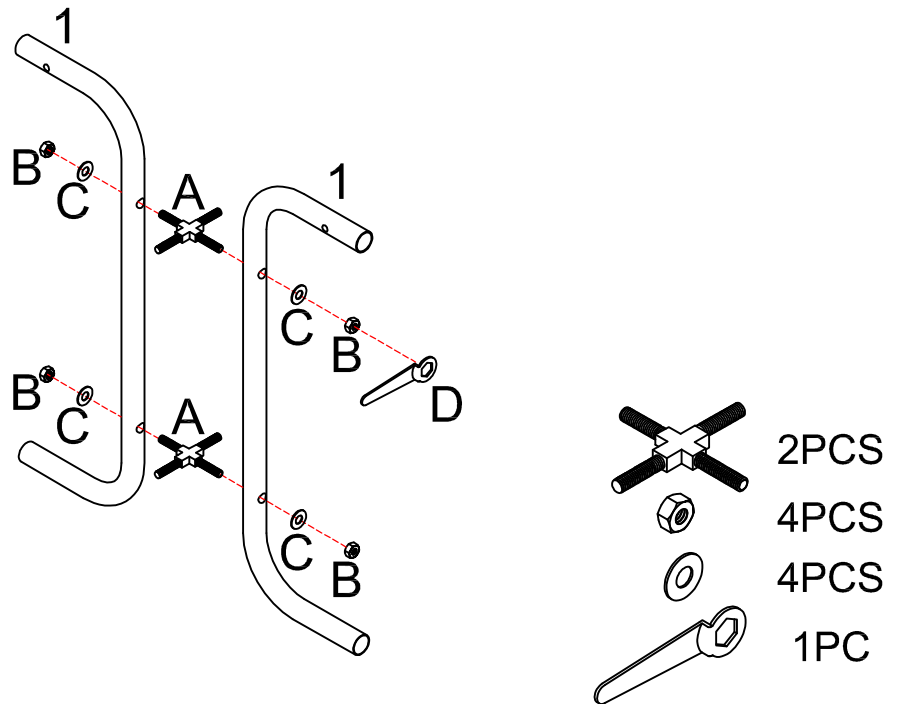

STEP 2 Attach the two remaining Support Legs (1) to the "+" bolts (A) using 4 Washers (C) and 4 Nuts (B). Do not tighten until after you have completed the entire assembly process.

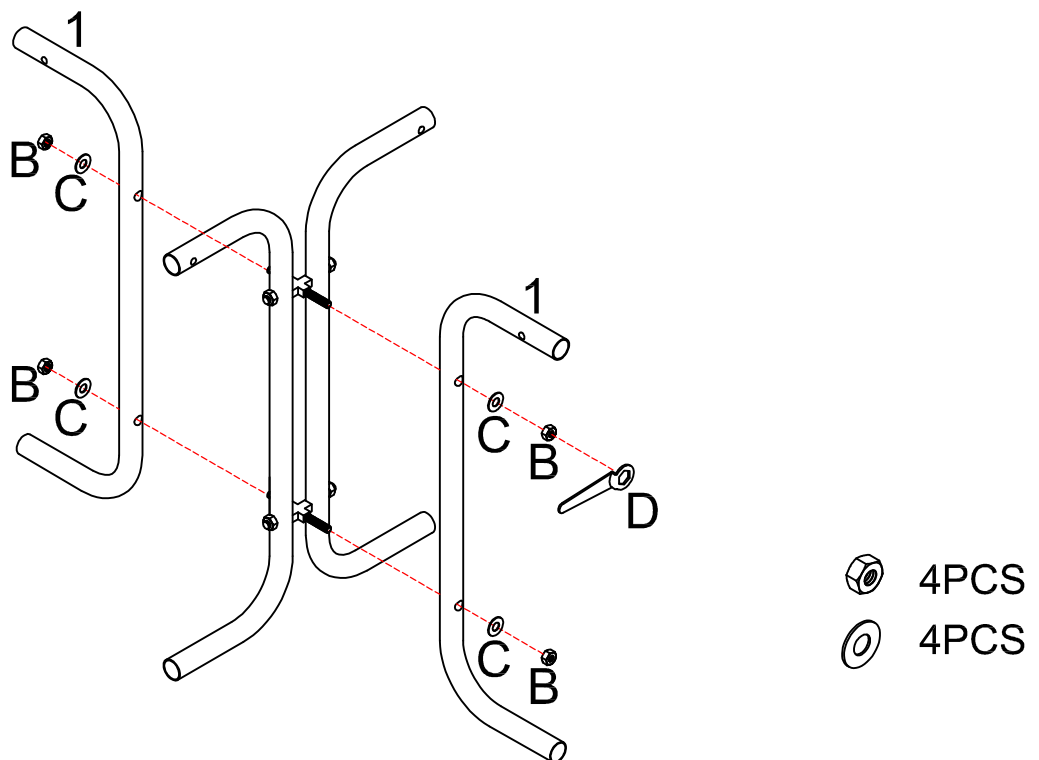

STEP 3 Attach the table top (2) to the base legs using 4 Bolts (E), 4 washers (C) and 4 nuts (B) by inserting each bolt into the bracket located under the table top and secure with the washer and nut. Repeat these steps for the remaining 3 brackets to secure the table top to the support legs.

Once assembly has been completed, you may tighten all nuts to firmly secure the patio side table. And add the Tube Cap (F) to the support legs (1).

