

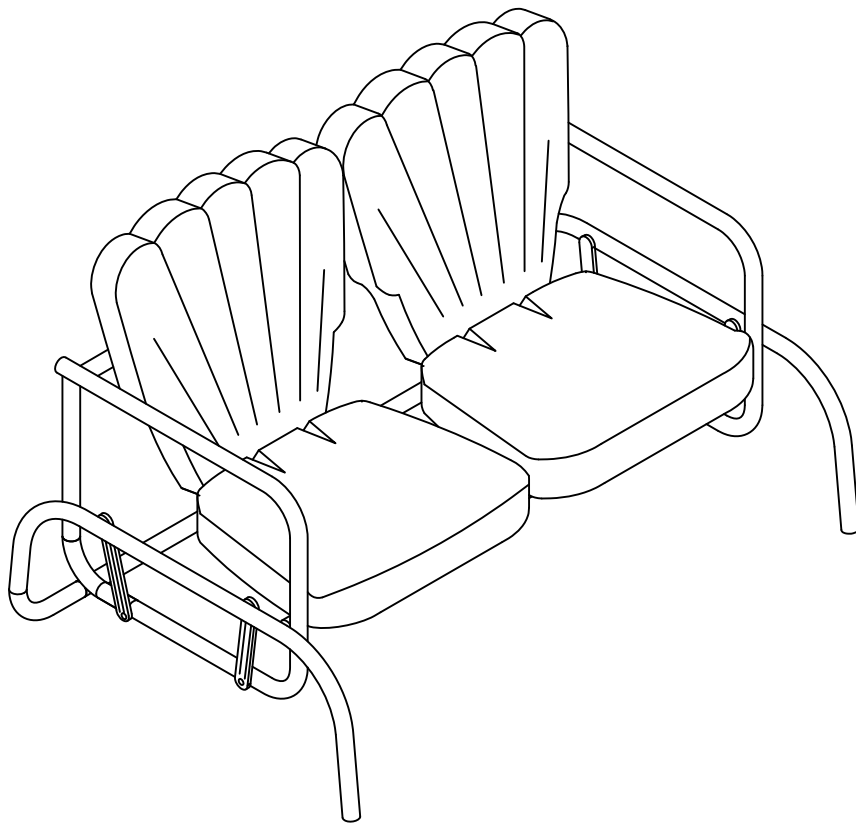

**CROSLEY**  
FURNITURE

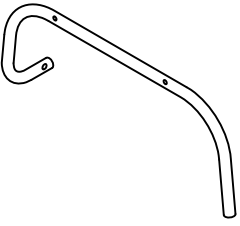

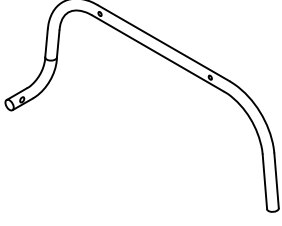

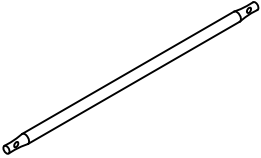

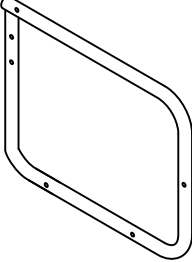
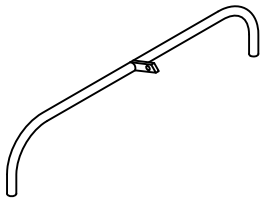
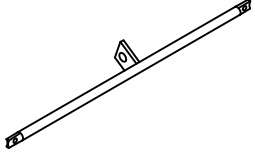
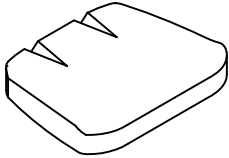
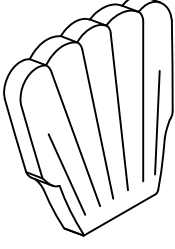

Loveseat Glider  
CO1032

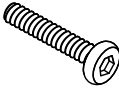
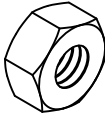

# PART LIST

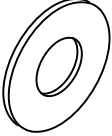
<p><b>A</b></p> 	<p><b>B</b></p> 	<p><b>C</b></p> 	<p><b>D</b></p> 	<p><b>E</b></p> 
<p>Left Support Leg 1 PC</p>	<p>Right Support Leg 1 PC</p>	<p>Leg Connector 1 PC</p>	<p>Swing Bar 4 PCS</p>	<p>Arm Frame 2 PCS</p>
<p><b>F</b></p> 	<p><b>G</b></p> 	<p><b>H</b></p> 	<p><b>I</b></p> 	
<p>Back Connector 1 PC</p>	<p>Seat Connecting Bar 1 PC</p>	<p>Seat Panel 2 PCS</p>	<p>Back Panel 2 PCS</p>	

# HARDWARE LIST

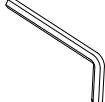



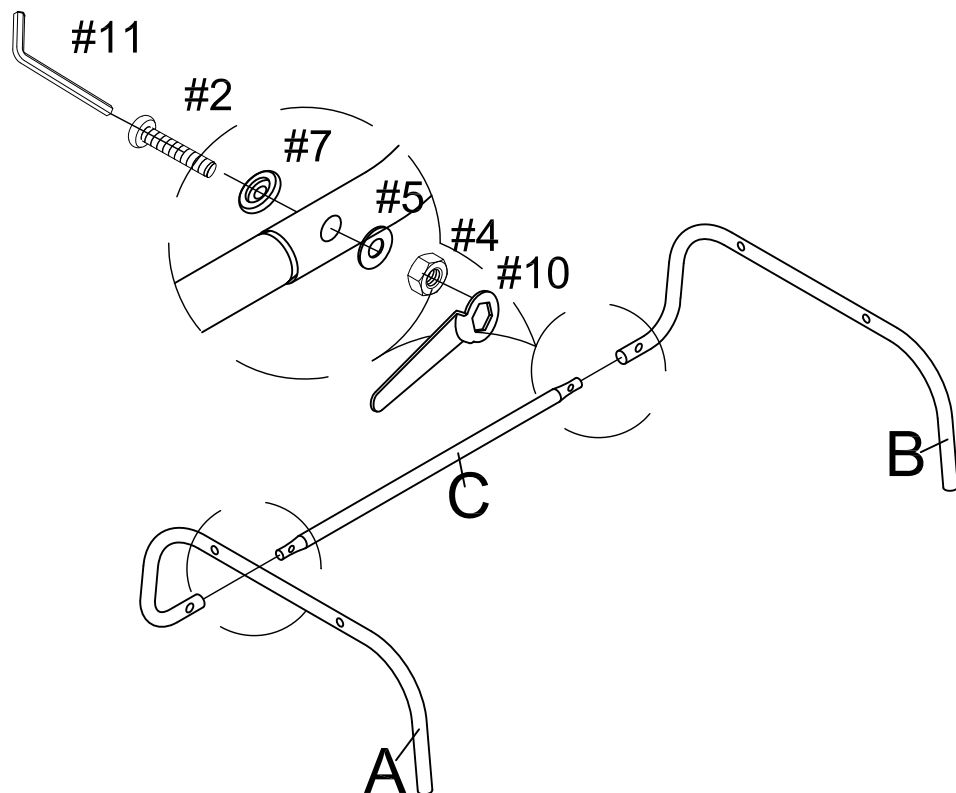

#1	#2	#3	#4	#5	#6
 M6X13mm	 M6X40mm	 M6X48mm	 M6X12mm	 M6X20mm	 M6X20mm
Bolt 7 PCS (Extra 1)	Medium Bolt 4 PCS (Extra 1)	Long Bolt 17 PCS (Extra 1)	Nut 28 PCS (Extra 1)	Small Flat Washer 26 PCS (Extra 1)	Large Flat Washer 16 PCS (Extra 1)
#7	#8	#9	#10	#11	
 Flat Plastic Washer 20 PCS (Extra 1)	 Plastic Washer 4 PCS	 Round Plastic Washer 2 PCS	 Wrench 1 PC	 Allen Wrench 1 PC	
Flat Plastic Washer 20 PCS (Extra 1)	Plastic Washer 4 PCS	Round Plastic Washer 2 PCS	Wrench 1 PC	Allen Wrench 1 PC	

**IMPORTANT NOTE: WE RECOMMEND TWO PEOPLE WORK TOGETHER TO ASSEMBLE THE UNIT**

**Step 1** Attach left support leg (part A) and right support leg (part B) to leg connector (part C) using medium bolts (part #2), flat plastic washers (part #7), small flat washers (part #5), nuts (part #4), wrench (part #10) and allen wrench (part #11).

NOTE: Please fully tighten bolts at this time.







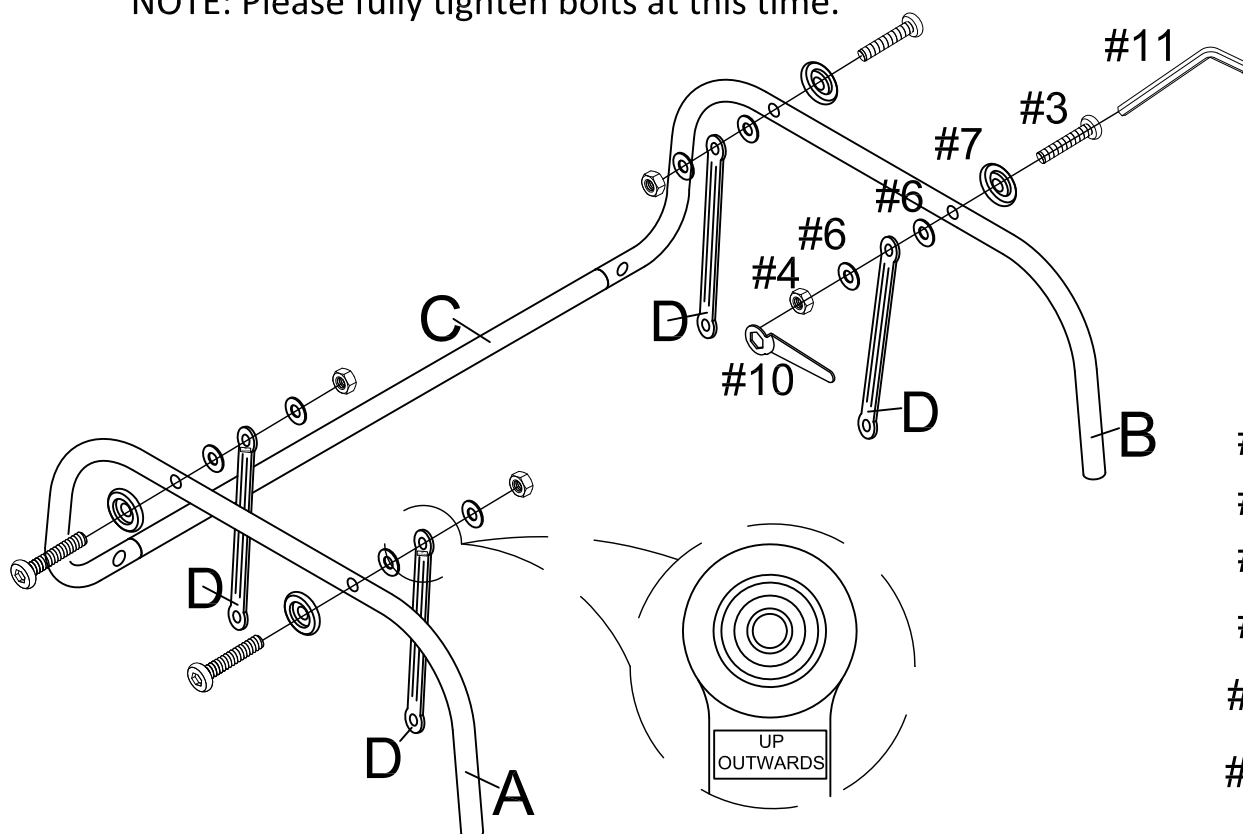

#2		X 2
#4		X 2
#5		X 2
#7		X 2
#10		X 1
#11		X 1

**Step 2** Attach swing bars (part D) to left support leg (part A) and right support leg (part B) using long bolts (part #3), flat plastic washers (part #7), large flat washers (part #6), nuts (part #4), wrench (part #10) and allen wrench (part #11).

NOTE: Please fully tighten bolts at this time.



#3		X 4
#4		X 4
#6		X 8
#7		X 4
#10		X 1
#11		X 1

**Step 3** Attach back connector (part F) to arm frames (part E) using long bolts (part #3), flat plastic washers (part #7), small flat washers (part #5), nuts (part #4), wrench (part #10) and allen wrench (part #11). Attach seat connecting bar (part G) to arm frames (part E) using medium bolts (part #2), flat plastic washers (part #7), small flat washers (part #5), nuts (part #4), wrench (part #10) and allen wrench (part #11).

**NOTE:** Please do not fully tighten bolts until unit is fully assembled.

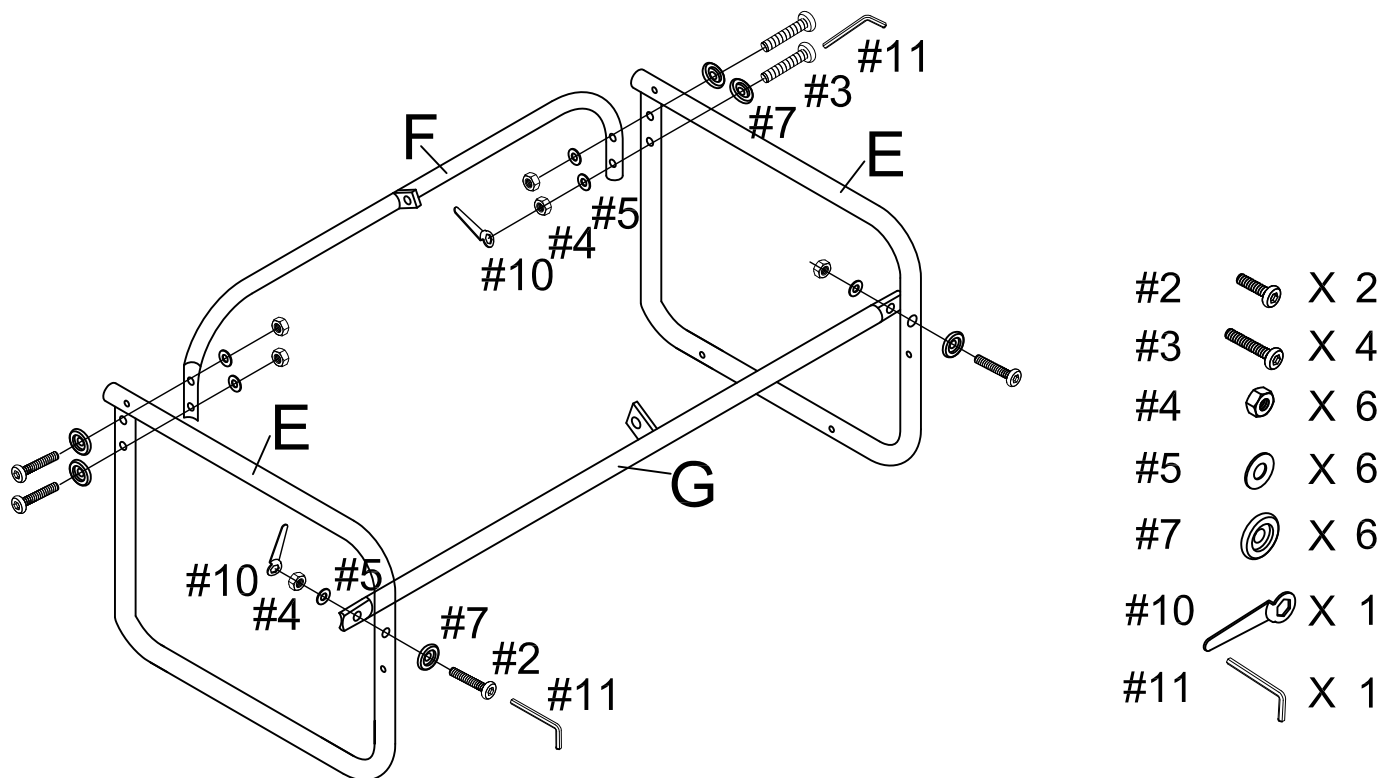

**Step 4** Attach seat panel (part H) to back panel (part I) using bolts (part #1), small flat washers (part #5), nuts (part #4), wrench (part #10) and allen wrench (part #11). Repeat for remaining seat and back.

**NOTE:** Please do not fully tighten bolts until unit is fully assembled.

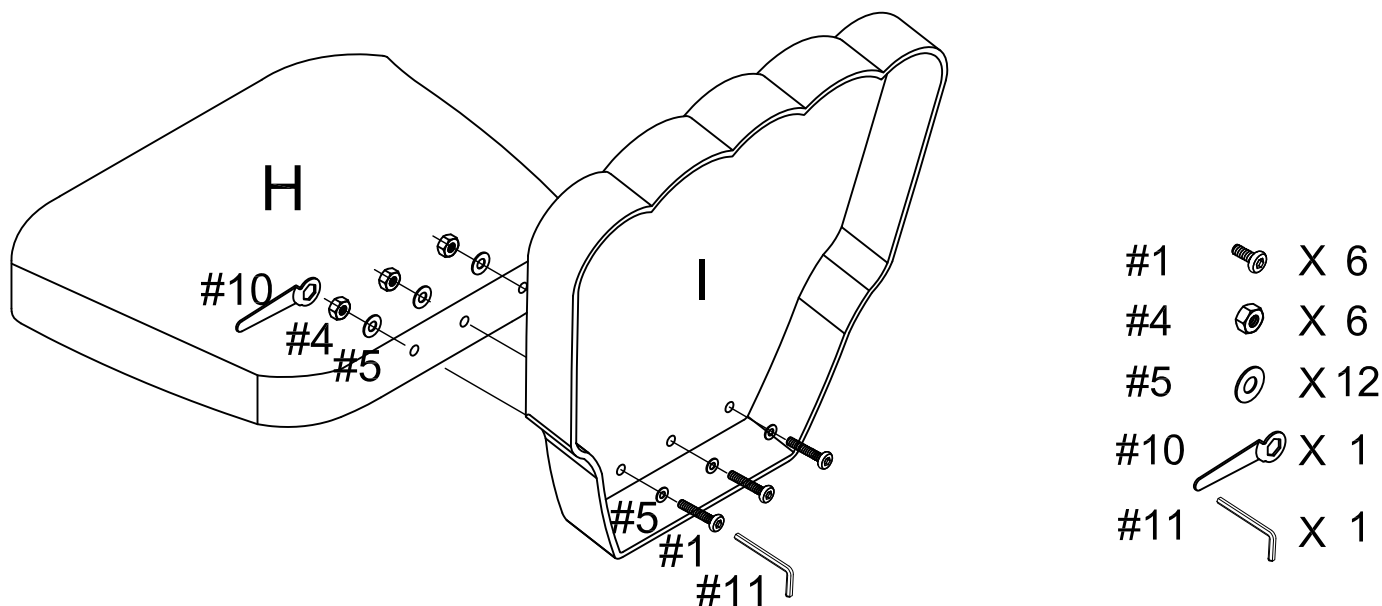

**Step 5** Attach assembled unit (parts H & I) to arm frame (part E) using long bolts (part #3), flat plastic washers (part #7), plastic washers (part #8), small flat washers (part #5), nuts (part #4), wrench (part #10) and allen wrench (part #11). Attach back panel (part I) to back connector (part F) using long bolt (part #3), small flat washer (part #5), round plastic washers (part #9) and allen wrench (part #11). Attach seat panel (part H) to seat connecting bar (part G) using bolt (part #1) and allen wrench (part #11).

NOTE: Please do not fully tighten bolts until unit is fully assembled.

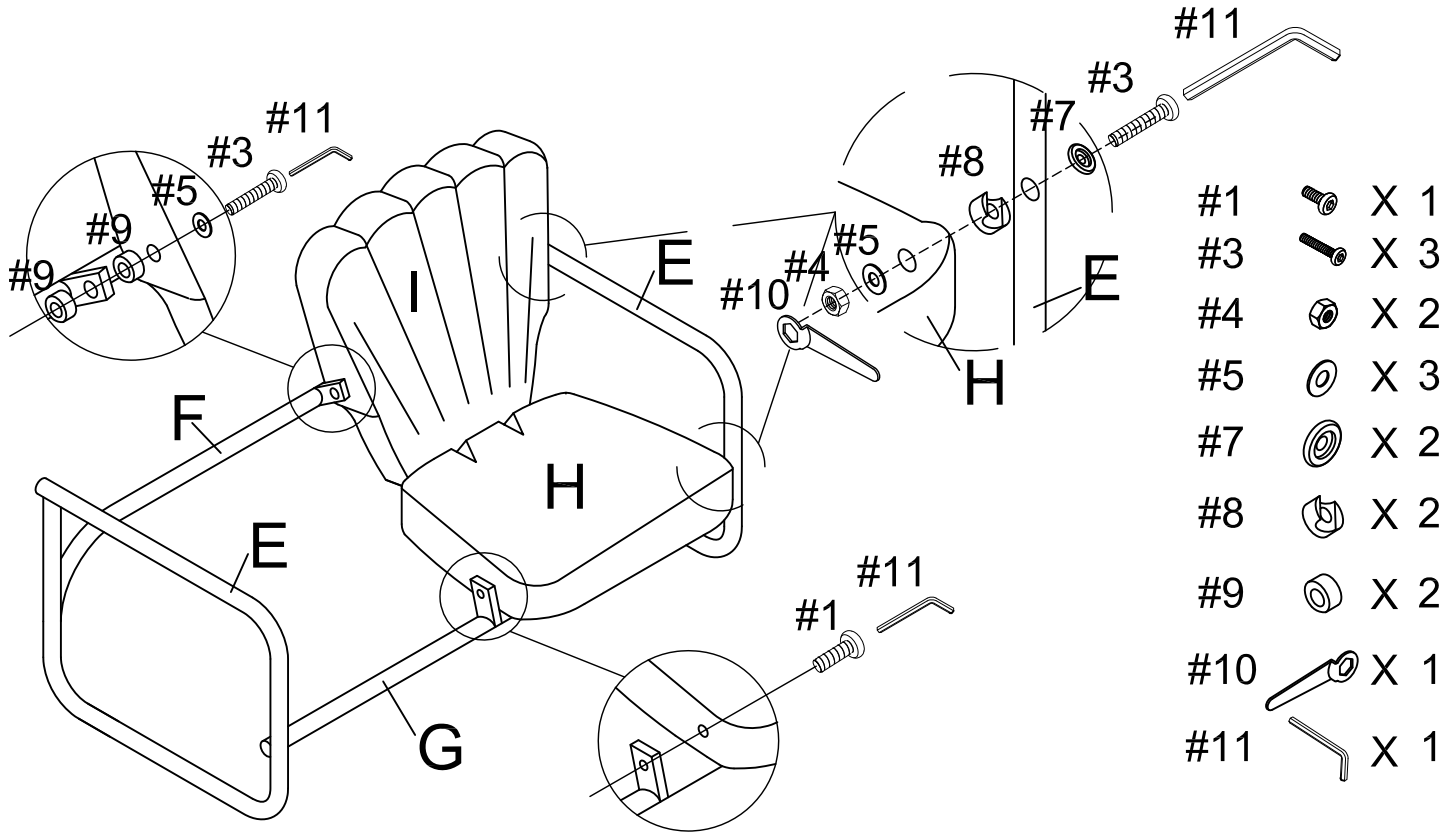

**Step 6** Attach remaining assembled unit (parts H & I) to arm frame (part E) using long bolts (part #3), flat plastic washers (part #7), plastic washers (part #8), small flat washers (part #5), nuts (part #4), wrench (part #10), allen wrench (part #11).



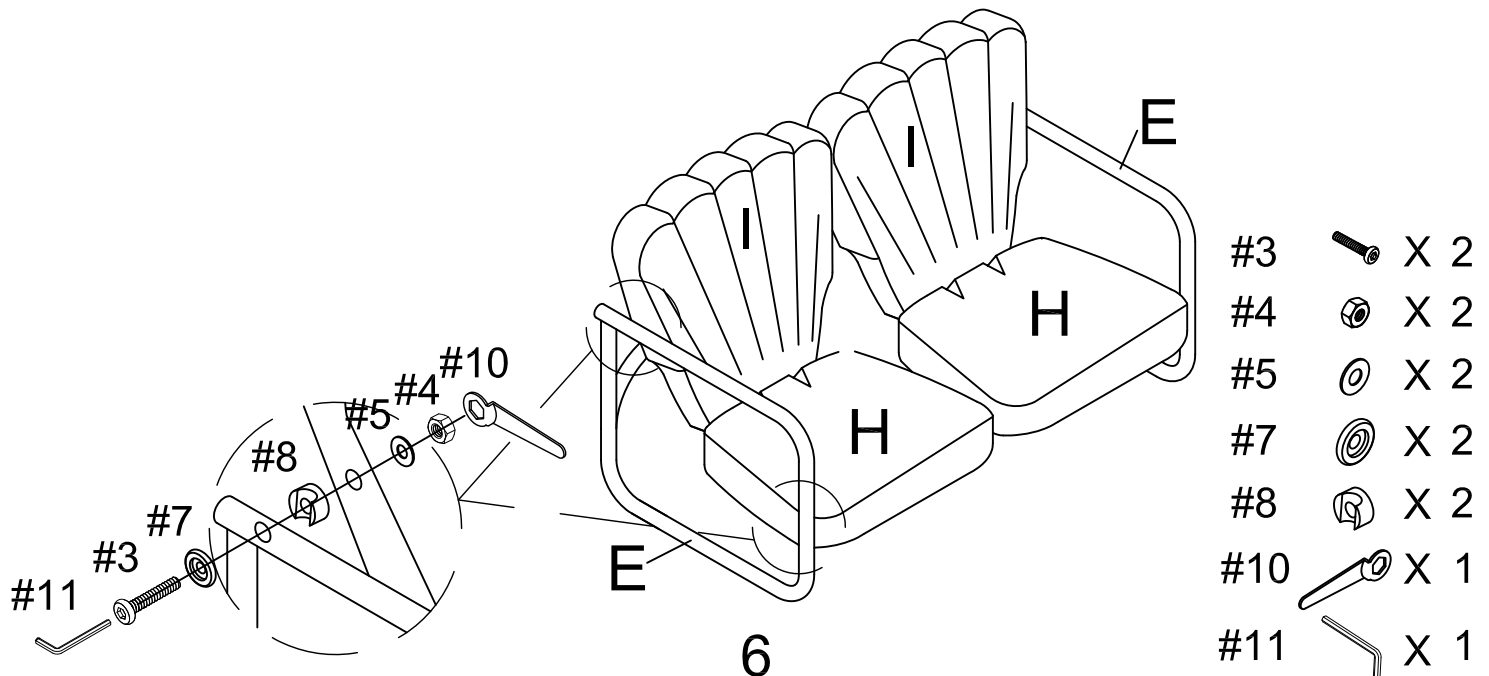

NOTE: Please do not fully tighten bolts until unit is fully assembled.

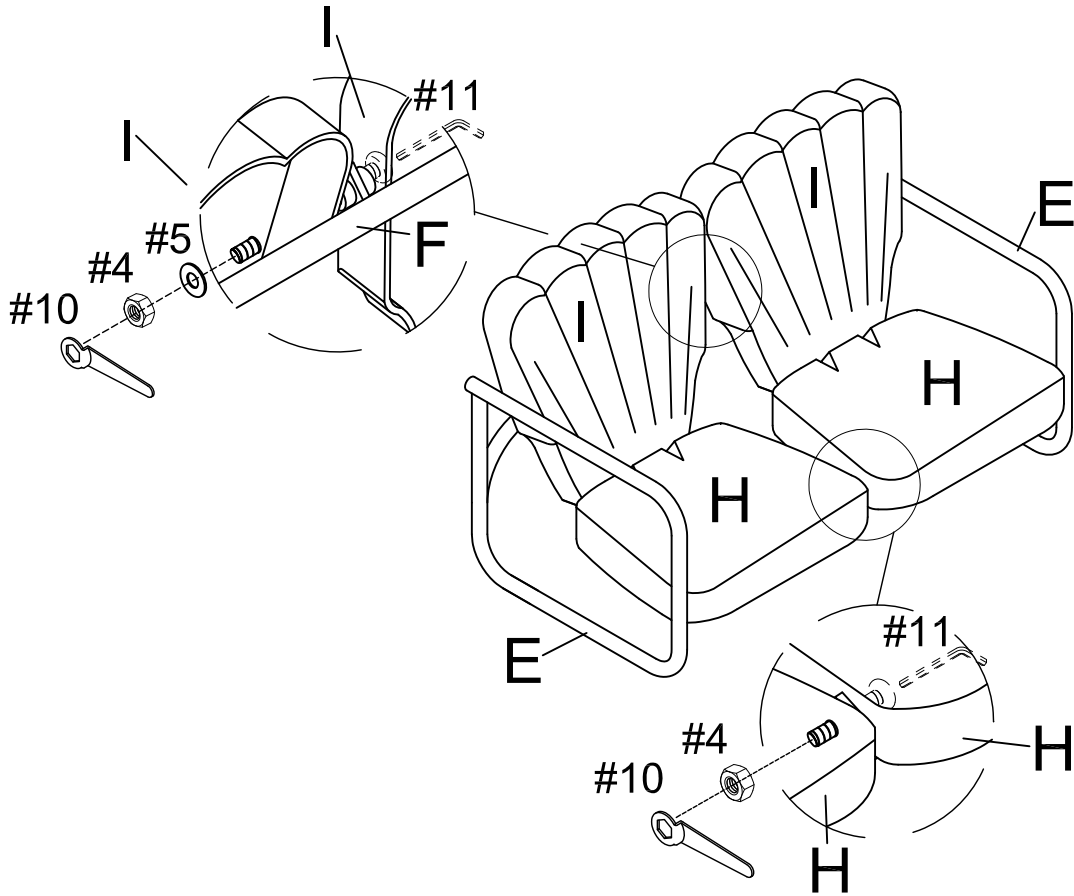

**Step 7** Tighten back panel (part I) to back connector (part F) and back panel (part I) using small flat washer (part #5), nut (part #4), wrench (part #10) and allen wrench (part #11). Tighten seat panel (part H) to seat connecting bar (part G) and seat panel (part H) using nut (part #4), wrench (part #10) and allen wrench (part #11).

NOTE: Please fully tighten bolts at this time.







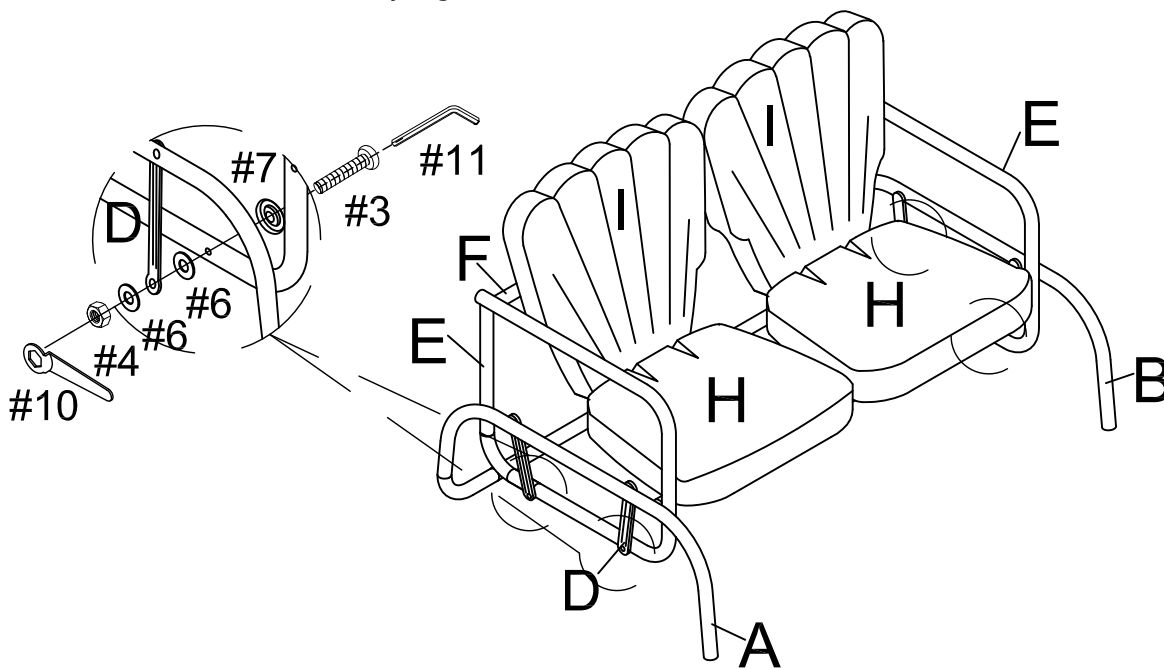

- #4  X 2
- #5  X 1
- #10  X 1
- #11  X 1

**Step 8** Attach assembled unit (parts E, F, G, H & I) to assembled unit (parts A, B, C & D) using long bolts (part #3), flat plastic washers (part #7), large flat washers (part #6), nuts (part #4), wrench (part #10) and allen wrench (part #11).

NOTE: Please fully tighten all bolts at this time.



- #3  X 4
- #4  X 4
- #6  X 8
- #7  X 4
- #10  X 1
- #11  X 1