

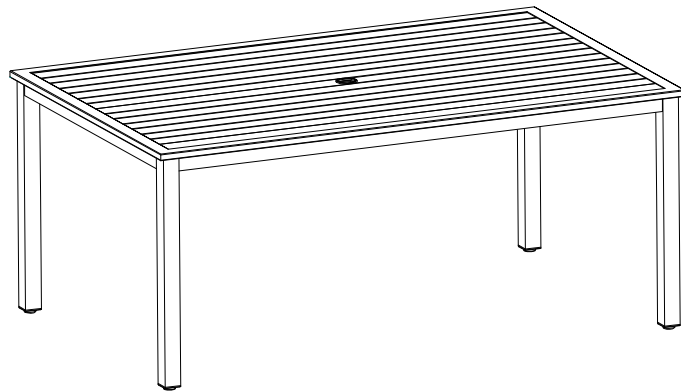

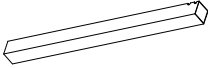

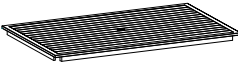

Outdoor Dining Table
CO6305

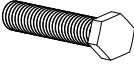

PART LIST

A 	B 
Leg 4 PCS	Top Panel 1 PC

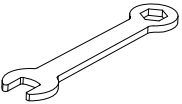
HARDWARE LIST

#1  M8*35mm	#2  M8mm	#3 	#4 
Bolt 8 PCS (Extra 1)	Flat Washer 8 PCS (Extra 1)	Wrench 1 PC	Cap 1 PC

Step 1. Lay top panel (part B) upside down on a soft flat surface, such as carpet, as shown below. Attach legs (part A) to top panel (part B) using bolts (part #1), flat washers (part #2) and wrench (part #3).

NOTE: Please fully tighten all bolts at this time.

NOTE: It is important to adjust levelers once fully assembled and upright. Extend adjustable leveler until it's firmly in contact with the floor. If relocating, adjust leveler as needed until it's firmly in contact with the floor in new location.

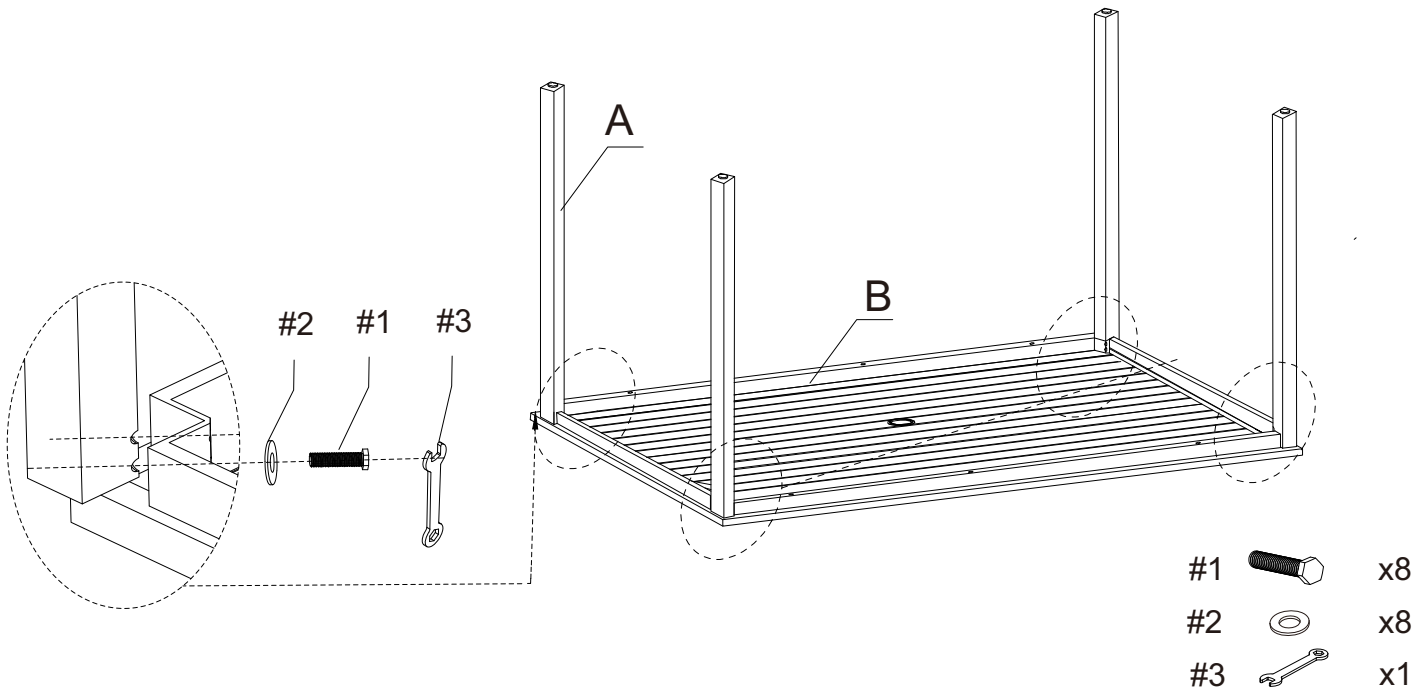

Step 2. Carefully turn unit upright. Attach cap (part #4) to top panel (part B).

