



Refuse





**OUT HERE,
IT'S PICK UP OR
SHUT UP.**



UNDISPUTED PERFORMANCE FROM THE LEADER.

Mack's lineup of refuse trucks dominates the industry. From commercial to residential jobs, when you want the work done right, turn to the trucks that do it best.



Front and Rear Loaders

Superior forward visibility and efficient use of chassis space mean you're able to confidently navigate tight spaces.



Transfer

Strong Mack® axles and *mRIDE* suspensions give drivers the durability needed for rugged transfer applications that can stretch hundreds of miles.



Side Loader

Do more with Mack. Our application excellence shines in advanced automated refuse collection vehicles with maximum driver productivity.



Roll Off

Our versatile chassis are built tough to withstand the full abuse of refuse applications.



TerraPro® Cabover

THE RULERS OF THE REFUSE INDUSTRY



Pinnacle™



The New LR Model

For over a century, Mack has led the charge when it comes to hauling refuse. And the refuse models Mack builds today aggressively defend that legacy — and push it forward — with best-in-class versatility and strength.



Granite® & Granite® MHD

TerraPro Cabover

Built to perform in the toughest jobs with the tightest spaces, TerraPro[®] is the refuse industry's best-selling cabover. Ideal for industrial and commercial applications, this truck improves productivity and reduces downtime while providing all-out cabin comfort.

Exceptional visibility

The TerraPro Cabover is designed from the beginning for outstanding visibility. A large windshield, low-profile dash, large mirrors and an ergonomic driving position make it easier to navigate narrow spots.

Fuel options

Diesel and natural gas are available. There's no sacrifice with TerraPro, only choices.

Body-ready electrical system

Cabovers come equipped with body-ready electrical systems so installation time is reduced. These systems ensure quality and prevent future reliability issues.

Improved productivity

Mack's long experience with all aspects of the refuse industry means we know how to boost your productivity. The fuel-efficient yet high-torque Mack[®] MP7[®] engine delivers faster route times and less downtime. And Mack's chassis engineering packs the maximum allowable payload into a compact overall dimension.

Capture comfort

Mack's contemporary cab provides ergonomic seats and controls to create an optimal driving experience.

Axle configurations

Available in single and tandem configurations, TerraPro Cabover can be customized with multiple drive and auxiliary axle combinations.

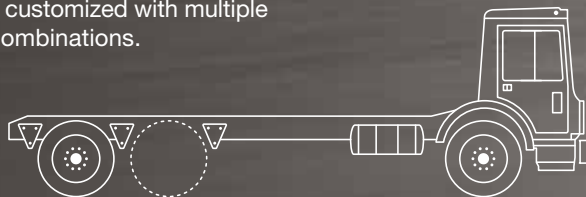





New Mack LR Model

The new Mack® LR model is unlike any truck on the market. It puts the driver's needs first with upgraded features designed to provide greater visibility and comfort for increased productivity. When you call for a truck to help tackle the demands of your day-to-day, Mack answers.

Superior visibility

Side loading and maneuvering narrow streets are made easier with rear wrap-around windows that increase your field of vision where you need it most.

Easy entry

LR model trucks reduce driver effort so you can do more. A low step 17 inches off the ground and large grab handles help drivers get in and out of the cab to ease the demands of a hard day's work.

Work brake

Operate your braking system with ease. A hand-operated work brake allows drivers to go from start to stop by parking the truck on its service brakes with one simple motion. That means less wear and tear and more productivity.

Expanded storage

These trucks make the most of cab space by packing in more storage than you thought possible. A centrally located storage platform creates a convenient spot to keep paperwork, a cell phone or an MP3 player—with extra room for a lunch box. Add cup holders for regular and large bottles, and there's a fit for everything on the job.

Ergonomic design

When it comes to taking command of demanding jobs, comfort is key. The LR model's extended cab offers more room to do the job your way. A tilt and telescopic steering column, new seat positions, suspended pedals, knee bolsters and arm rests let drivers adjust their truck for improved comfort and efficiency. Plus, the integrated air conditioner provides a factory-installed climate-controlled environment that supplies relief on the hottest days.

Chassis configurations

Designed for easy body installation, the LR model is currently available in a tandem-drive configuration.

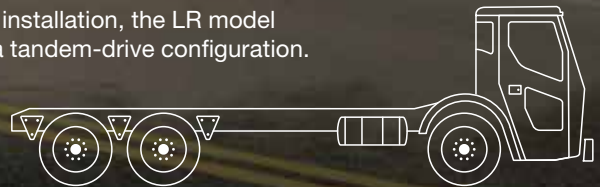

New LR model: Design your ideal drive.



Wraparound Windows

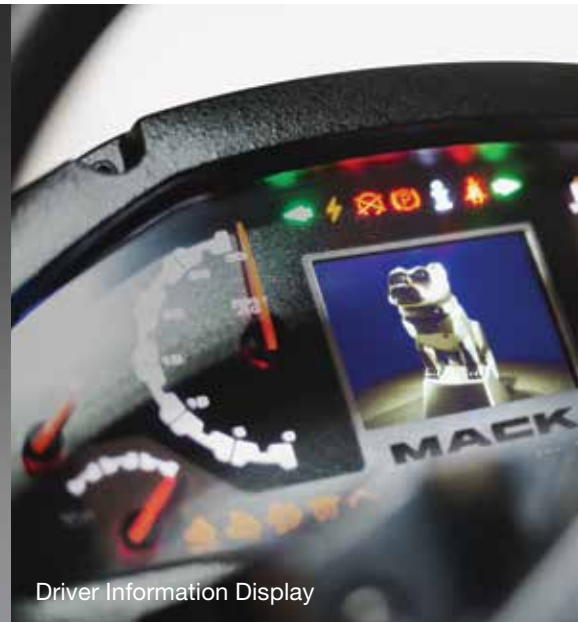

Driver Information Display



Integrated Air Conditioning



Expanded Storage Platform



USB and Bluetooth Connectivity



Mack's tradition of application excellence means you do more than get the job done —you own it. Our new LR models offer multiple driving and door options to eliminate downtime and keep the driver firmly and efficiently in charge of the workday.

Four driving configurations

Don't compromise driver comfort. You spend your day behind the wheel, so you should own the ability to choose a driving configuration

that's going to cater to your needs. Whether you prefer standup or seated, left- or right-hand steering, Mack gives you the choices you need.



Standup

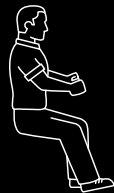

Seated

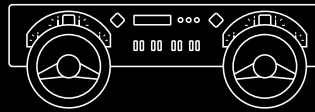

Left-hand

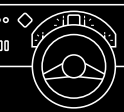

Right-hand

Six door combinations

Open the door to productivity: The LR model has some of the largest doors in the industry for easy entry and egress, with three door configurations

and six door combinations to suit your needs. Choose between standard, flip, and bi-fold designs, and step into an easier way to work.

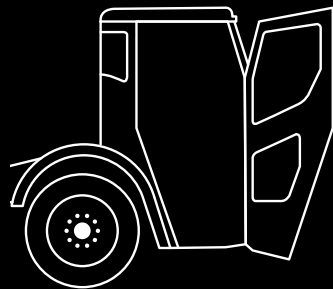

Standard Door

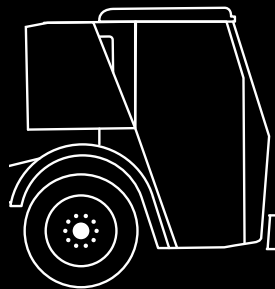

Flip Door

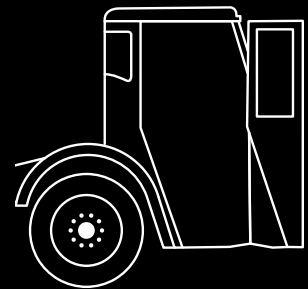

Bi-fold Door

Granite & Granite MHD

To endure the daily grind of the refuse industry, you need a truck that's built stronger than the job itself. Granite® is built to deliver maximum power while Granite® Medium Heavy Duty (MHD) is spec'd for lighter-duty applications, and both vehicles are nothing less than tough and versatile.

Maneuverability

Get a shorter truck with a tighter turning radius. Compact component packaging and a wide pivot significantly improve your overall maneuverability on the job.

Heavy-duty cross-members

Drive durability: Heavy-duty cross-members give your truck the strength to stand up against the relentless pounding of the refuse industry.

Strong suspensions

Mack doesn't compromise on toughness. Our suspensions are built strong and reliable to take on any refuse jobs, no matter how severe.

Frame rail versatility

A choice of rail widths offers increased flexibility so that your Granite comes ready for the rigors of refuse.

Compact fuel tanks

When you're trying to fit your truck into tight spots, shorter overall length is better. Compact fuel tanks mean you have everything you need, and nothing you don't.

Axle configurations

Available in single and tandem configurations, Granite and Granite MHD can be customized with multiple drive and auxiliary axle combinations.



Granite



Granite MHD





Pinnacle Tractor

It doesn't matter if you're transporting a heavy load or deadheading, you want a powerful truck to propel you from the transfer station to the landfill and back again, without sacrificing fuel efficiency. You want the purpose-built, refuse-tested Mack® Pinnacle™ tractors.

Fuel efficiency

Whether you're deadheading or driving with a full load, your truck is using fuel. That's why these trucks are engineered to offer maximum fuel efficiency for both job conditions. Mile after mile, from transfer station to refueling station, Pinnacle tractors save you money.

Unyielding frame

These trucks are built to shrug off the abuse of the job. Maintain Pinnacle strength with heavy-duty cross-members and frame rails, offered in multiple sizes to best fit your truck.

Ideal driver environment

It's all about productivity. Our ergonomic interiors combine quiet comfort, enhanced visibility and a functional instrument cluster to keep drivers happy and safe.

mDRIVE™

In refuse transfer, heavy loads can be hauled hundreds of miles. That's why mDRIVE transmissions are designed to make pulling big loads easier, safer and smarter. This 12-speed automated manual transmission maximizes payload and performance.

Rugged balance

These aren't your typical trucks. Made with sturdy axles and suspensions to maintain a lightweight ride, they're strong enough to travel off-road, but light enough to make the most of your payload.

Axle configurations

Available in single and tandem configurations, with axle forward or axle back front axle position, Pinnacle tractors can be customized with multiple drive and auxiliary axle combinations.

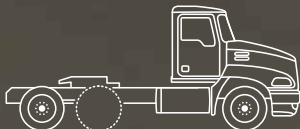

Pinnacle Axle Back

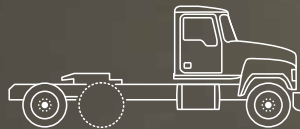

Pinnacle Axle Forward





Powertrains that pack a punch.

Equipped with strong Mack® engines and transmissions, you increase efficiency without sacrificing power.



MACK® *mDRIVE*™ HD

Mack's lightweight *mDRIVE* HD is the 12-speed, two-pedal transmission that comes standard on Granite® trucks so you don't compromise on performance. It's built tough to overpower whatever gets in your way, and it's fully integrated for improved efficiency, increased uptime and lower cost.

MACK® ES T300 TRANSMISSION

The Mack Maxitorque® ES transmission is rugged enough to take on any challenge. Available on Mack® Pinnacle™ and Mack® Granite® refuse models, it offers easy shifting with a lightweight aluminum case and the industry's only triple-countershaft design. It also boasts the most PTO mounting options.



ALLISON® AUTOMATIC TRANSMISSION

TerraPro® models are available with a choice of Allison 3000, 4000 and 4500 series automatic transmissions, making it simple to match your application to the right transmission for the job.

MACK® MP® ENGINE SERIES

The MP engine series is the heartbeat of the refuse industry. These highly fuel-efficient engines deliver plenty of horsepower plus great, low-end torque to give you all the muscle you need to conquer the road.

The lightweight MP7® engine has a range from 325 HP to 405 HP, and torque ratings from 1,200–1,560 lb.-ft. While the brawnier MP8® provides horsepower from 415 HP to 505 HP and torque ratings from 1,460–1,860 lb.-ft.

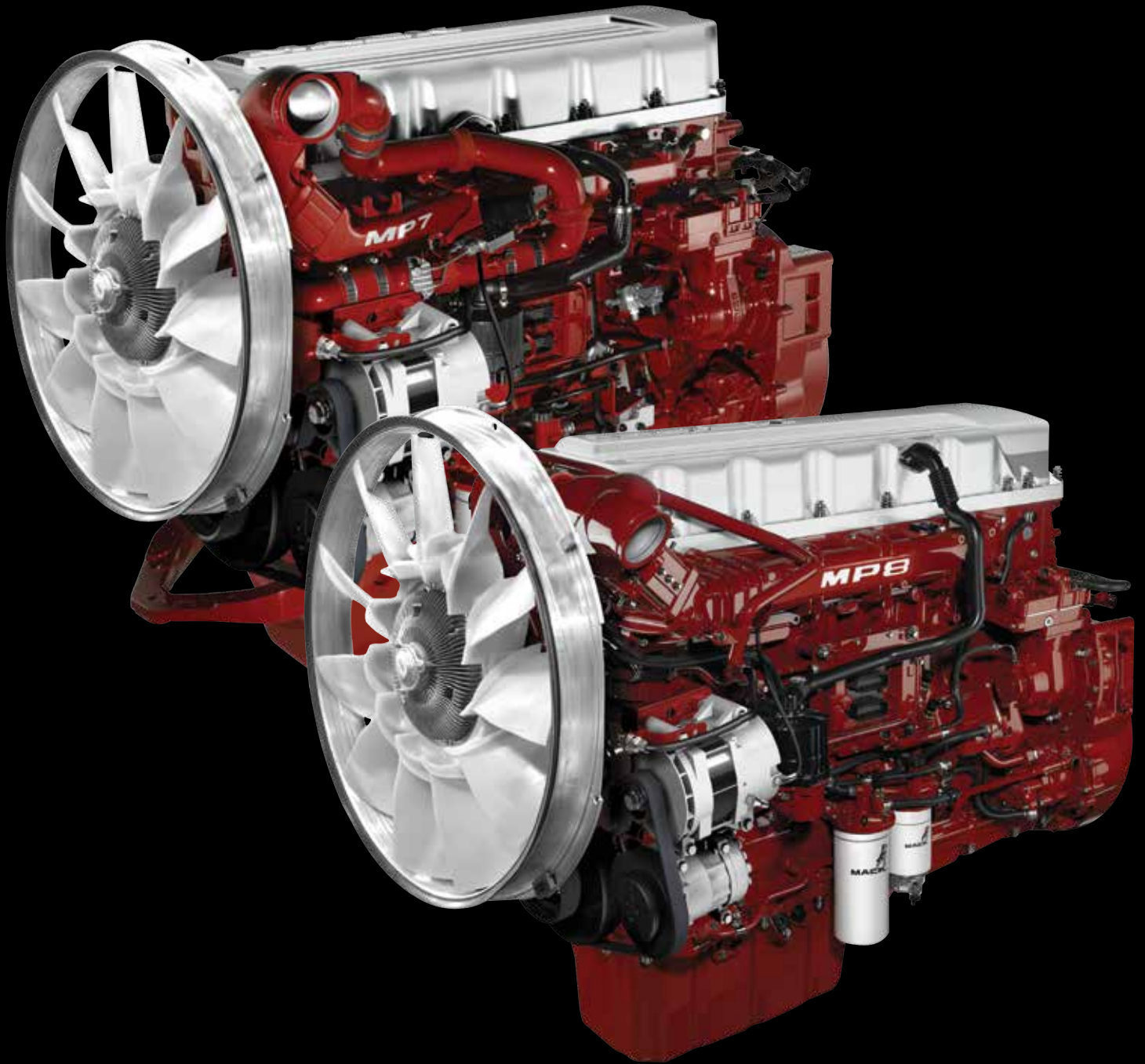

Axles and suspensions provide the foundation for Mack's reputation of rugged reliability. They offer increased durability for a smoother ride, because the only thing you should feel on the road is complete control.

Tough enough for the roughest roads.



MACK® AXLES

Proprietary Mack Axles provide greater performance on the most demanding jobs. Our C150/151 and 200 Series axle carriers deliver great fuel economy and improved reliability.



MACK® CAMELBACK

The Camelback suspension is built with increased stability to handle the stress of on- and off-road refuse applications. This tried-and-true suspension allows for better steering and reduced tire wear. Camelback is available from 38,000- to 58,000-lb. ratings on TerraPro®, Granite® and Pinnacle™ refuse trucks.



MACK® *mRIDE*

With *mRIDE*, Mack delivers the next generation in spring suspensions to ease the workload for refuse trucks. This suspension's extreme articulation and constant ground contact for all wheels maximizes traction and improves stability. Mack *mRIDE* is available in 40,000-, 46,000- and 52,000-lb. ratings on TerraPro and Granite refuse models.



Clean up at the pump

Fill up with pride. The natural-gas-powered TerraPro® and new LR model refuse trucks combine fuel choice with the savings you demand. We've partnered with the leading natural gas engine manufacturer, Cummins® Westport, to deliver the best alternative fuel technology to power your business.



SEE SAVINGS AT THE PUMP

Whether you're operating one truck or an entire fleet, it's all about boosting your bottom line. TerraPro and LR model Natural Gas trucks are capable of running on compressed natural gas (CNG), liquefied natural gas (LNG), landfill gas (LFG) or hydrogen-compressed natural gas (HCNG). This leads to lower overall lifecycle costs and greater savings to pump back into your business.

ACCEPT NO SACRIFICES

Don't sacrifice when choosing your truck. Mack offers a complete suite of products for natural gas models. That means when deciding between alternative fuel and diesel, you won't have to make concessions to meet your refuse needs.

THE BEST OF BOTH WORLDS

These TerraPro and LR model trucks meet current EPA and CARB emissions levels by lessening the carbon footprint and lowering greenhouse (CO₂) emissions. And because natural gas is readily available in North America, they're also reducing this country's dependency on foreign fuel.



A history fueled by purpose.

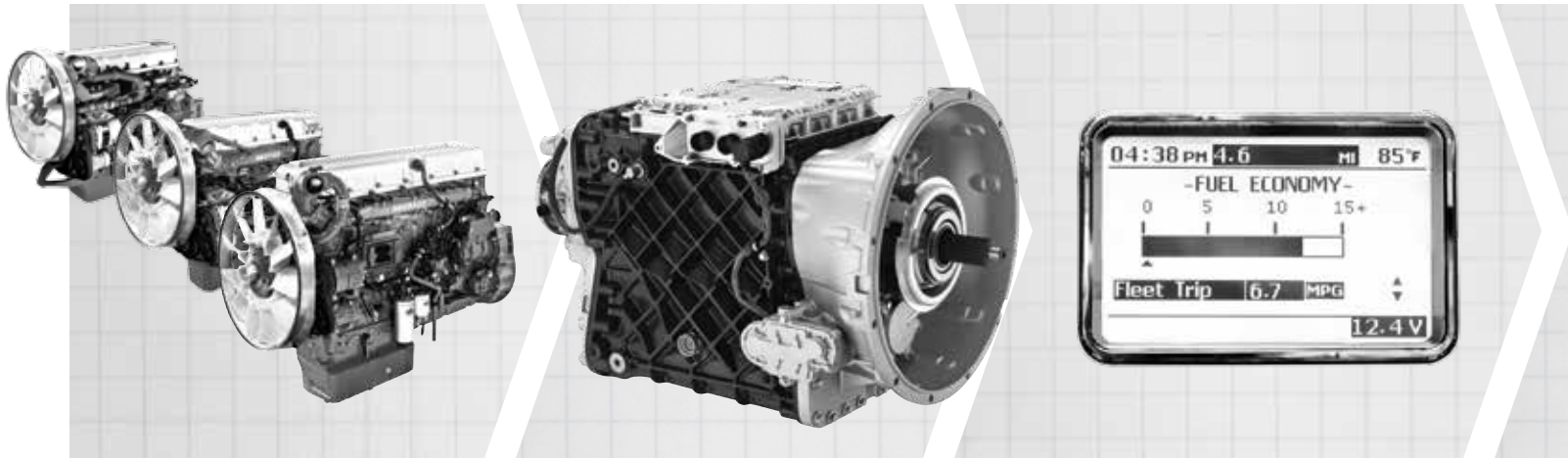

Mack® Engine Series

With muscle, torque and great fuel economy, Mack MP engines conquer the workday, mile after mile.

Mack® Transmissions

Mack's transmissions are designed and built to perform at the highest level in the most demanding conditions, just like the rest of the truck.

Mack® Electronics

Featuring proven V-MAC® IV electronics, Mack makes it easier to work the way you want. Effortlessly manage your truck and engine, so you save on fuel and boost your bottom line.

Driving a Mack® is about more than the truck. It's about the experience. That's why, since 1900, we've been putting our pride to work—integrating legendary trucks, parts, services and dealers in the name of showing what it truly means to drive a Mack. Because the way we see it, it's our business to ensure you can run yours.



Mack® Axles

Mack axles and carriers are engineered to handle heavy hauls and the relentless punishment of the job.

Mack® Suspensions

We've engineered Mack suspensions so they're lighter and stronger, giving you enhanced reliability and outstanding performance no matter where you go. Which, with a Mack truck, can be almost anywhere.

Uptime Solutions

We work to deliver legendary Mack parts and services with our Uptime Solutions. Spend less time in the shop and more time on the job, where you belong.

The Integrated Leader

In 1900, we started this journey. A journey toward fully integrated trucking that's become a century of improving everything that makes your Mack a Mack.

**Everything your Mack® needs.
Every place you need it.
America's truck knows
no boundaries.**



NETWORK SUPPORT

Mack Dealer Network

Every Mack is supported by more than 400 authorized dealer and parts and service locations. These dedicated locations have invested in a level of service fit for a Mack truck—ensuring that you are greeted by knowledgeable staff, that you get in and out quickly and that your truck gets fixed right the first time.

Parts Purchasing

Mack makes it easy to get the right parts at the right time. From parts programs for entire fleets to a web-based program that provides 24/7 access to parts, we make sure you have access to the parts you need, when you need them.

Customer Training

When you purchase a truck from Mack, Mack Trucks Academy offers best-in-class training for your shop staff to improve uptime and your bottom line. Choose from instructor-led or online training to get your staff up to speed.



UPTIME SOLUTIONS

GuardDog® Connect

GDC monitors your vehicle's performance the entire time it's operating to enable quick diagnosis of issues, schedule repairs and order parts—all while the truck is still on the road. With GuardDog Connect, you're always connected to a 24/7 network of support staff and repair centers, so you stay on schedule.

OneCall®

Mack OneCall provides 24/7 support for your truck. It combines an unparalleled customer support network with a state-of-the-art Uptime Center to bring the experts you need together under one roof.

ASIST

Mack ASIST is a web-based system that assembles consistent, complete and professional estimates of service recommendations, regardless of which dealer in the Mack Network performs the service. ASIST gives you, the dealer and Uptime Center staff access to all information, getting you back on the road faster.

Diagnostic Tools

Mack's easy-to-use, PC-based diagnostic software gives you access to the information you need. From quick diagnostics to EPA emission data and key metrics for Mack trucks with Mack engines, you can monitor your fleet in real time.



Your truck should come on your terms.

Take control with Mack's complete business services.

From financing to premium maintenance packages, Mack has what you need to get, and keep, your truck on the road.

MACK FINANCIAL SERVICES

Mack offers comprehensive financial services that include customized loans, leases and payment plans. You choose the terms, then Mack comes up with the payment plan and coverage that works for you, so you can build your business.

FLEET MANAGEMENT SERVICES

Mack's unique suite of offerings makes fleet management fast and easy. Mack partners with best-in-class software providers and telematics services to deliver the intelligent tools you need to manage your fleet.

MACK LEASING SYSTEM

Mack offers full-service leasing and rental services backed by our growing association of MLS dealer members. Whether you're looking to lease your fleet, rent a truck or outsource your maintenance, Mack has a variety of solutions to meet your needs.

PREMIUM MAINTENANCE PLANS

Mack takes the worry and hassle out of maintenance with premium plans that provide nationwide maintenance coverage at any authorized Mack dealer location. Select a plan and pay upfront so that your truck's interval maintenance is covered—no payment or paperwork required.

WARRANTY AND PROTECTION PLANS

Mack offers the most flexible warranty program in the industry. Whether you need a standard warranty or a premium protection plan, Mack can customize a plan to meet your specific business requirements.

**MACK[®] TRUCKS ARE
TOUGH ENOUGH TO
CARRY AN ENTIRE
INDUSTRY ON THEIR
BACKS.**







1-800-922-MACK
MackTrucks.com

 facebook.com/MackTrucks

 twitter.com/MackTrucks

 youtube.com/MackTrucks

 linkedin.com/company/mack-trucks

 plus.google.com/+macktrucks/posts

BORN READY.