



Highway





**OUT HERE, YOU
HAVE TO ANSWER
THE CALL AND
HANDLE THE HAUL.**

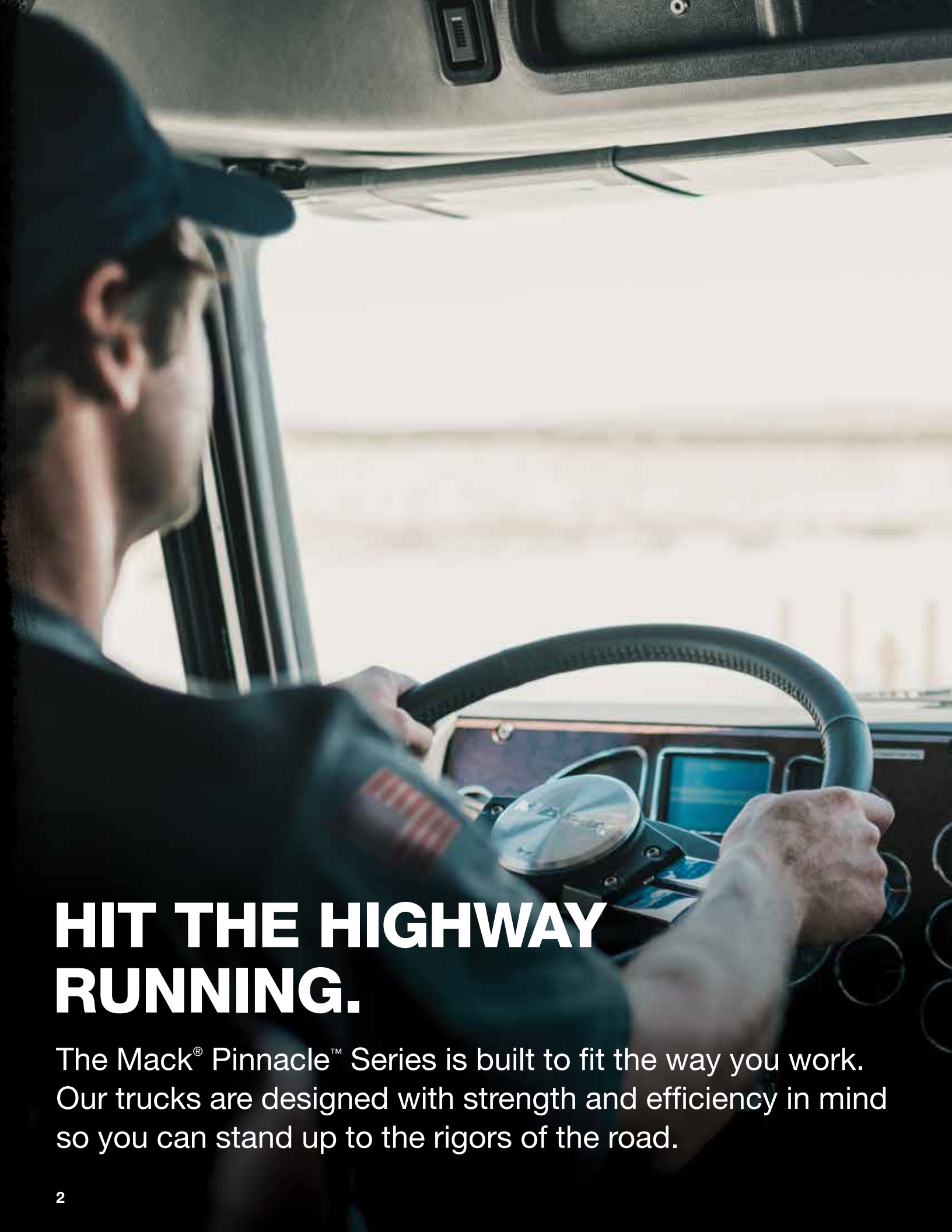

HIT THE HIGHWAY RUNNING.

The Mack® Pinnacle™ Series is built to fit the way you work. Our trucks are designed with strength and efficiency in mind so you can stand up to the rigors of the road.



Long Haul

Auxiliary power units let you stay comfortable without idling, while an aerodynamic body and SmartWay® certified components cut fuel costs.



Regional Hauling

The Pinnacle carries the lowest costs of operation and ownership in the industry.



Flatbed and Lowboy

A Pinnacle spec'd for flatbed or lowboy jobs boasts an improved turning radius for tight spots.

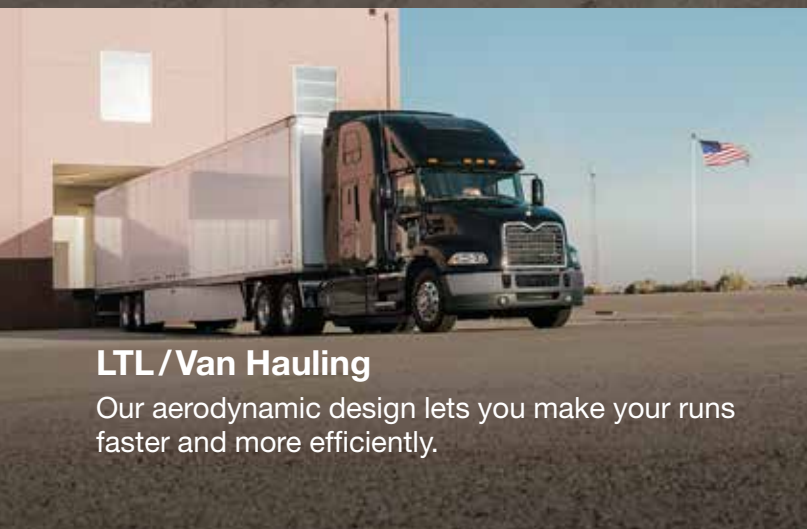

LTL/Van Hauling

Our aerodynamic design lets you make your runs faster and more efficiently.



Bulk Hauling

The 6x2 suspension reduces your fuel consumption and helps you haul larger loads.

WE ENGINEER THE HEROES OF THE HIGHWAY.

These trucks transport pride. Armed with every advantage, Mack® Pinnacle™ models are incredibly reliable and fuel-efficient—and they need to be. Because we don't just move cargo from coast to coast. We carry this country forward.



Pinnacle™ Sleeper



Pinnacle™ DayCab



Pinnacle™ Rawhide® Edition

Pinnacle Sleeper

The Mack® Pinnacle™ Sleeper is designed with the comfort drivers want and the components the road demands. From heavy loads to steep grades to long hauls, this truck has the power to handle payloads and the efficiency to run longer.

Optimization

Whether your haul takes you across the county or across the country, the Pinnacle Sleeper can be customized for whatever job you set out to do.

Gear fast, run slow

On the road, torque trumps horsepower. High torque means you can run your Mack at low engine speeds to make the most of your fuel.

Auxiliary power units

Operate sleeper power, heating and AC independent from your truck. Remain idle-free and save on fuel without sacrificing comfort.

Rest effectively

You work hard. So when you take a break, your ride is equipped with all of the right amenities. Rest effectively and rise ready to take on another day.

High-rise

Designed to accommodate your longest drives, our spacious 70-inch high-rise sleepers have plenty of room to keep you comfortable.



Axle Back



Axle Forward

Mid-rise

Ideal for regional hauls, our 60- and 70-inch mid-rise sleepers supply the space to keep you relaxed, no matter what your haul requires.



Axle Back



Axle Forward

Flattop

Whether you're up against an overnight haul or facing a day trip with long waits, Mack's 48- and 56-inch flattop sleepers fit your needs.



Axle Back



Axle Forward



Pinnacle Sleeper



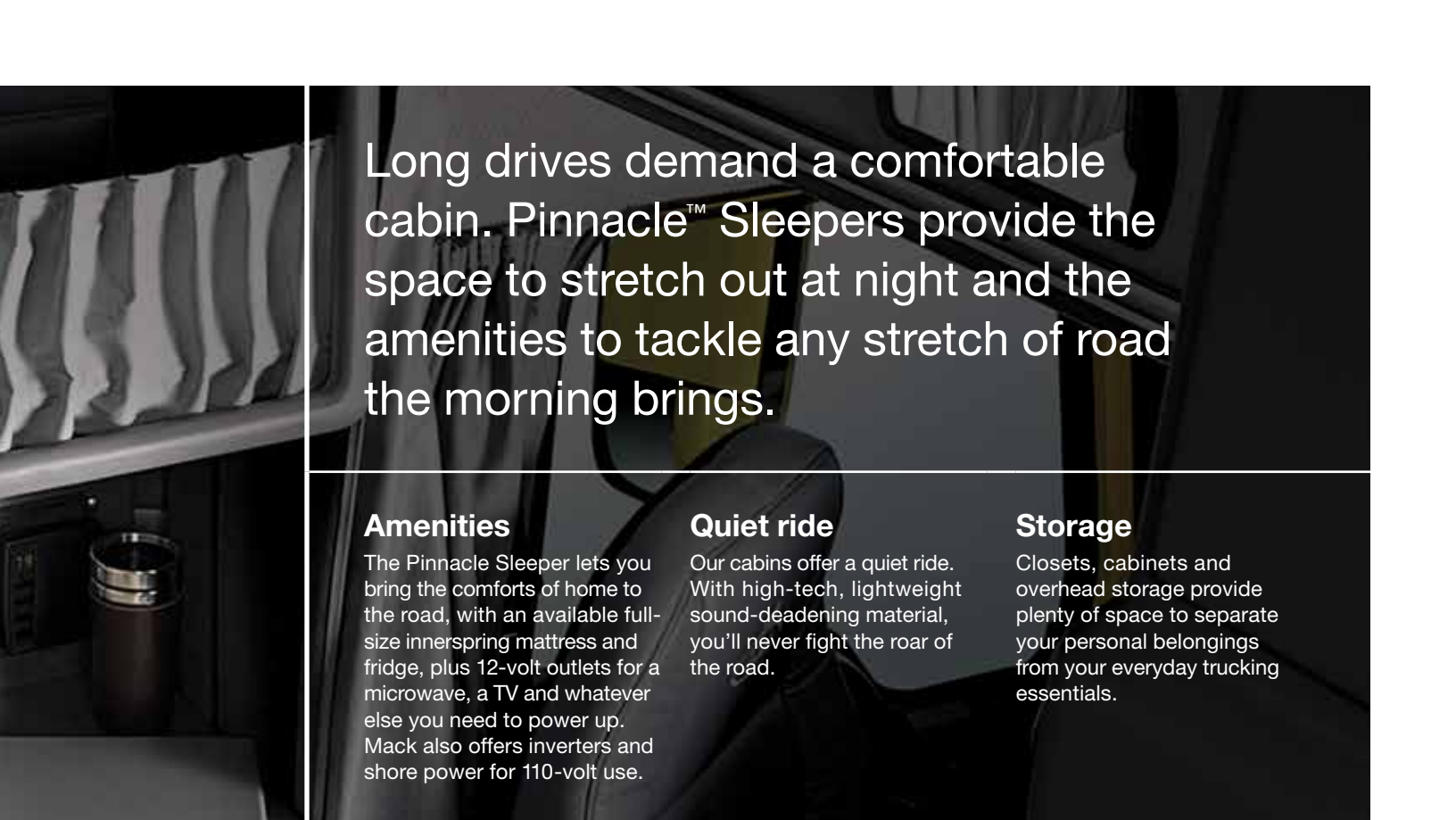

Long drives demand a comfortable cabin. Pinnacle™ Sleepers provide the space to stretch out at night and the amenities to tackle any stretch of road the morning brings.

Amenities

The Pinnacle Sleeper lets you bring the comforts of home to the road, with an available full-size innerspring mattress and fridge, plus 12-volt outlets for a microwave, a TV and whatever else you need to power up. Mack also offers inverters and shore power for 110-volt use.

Quiet ride

Our cabins offer a quiet ride. With high-tech, lightweight sound-deadening material, you'll never fight the roar of the road.

Storage

Closets, cabinets and overhead storage provide plenty of space to separate your personal belongings from your everyday trucking essentials.



Mini Fridge



Full-Size Closet



HVAC Controls



Sleeper Back



Sleeper Bunks



Overhead Storage

Pinnacle DayCab

The Mack® Pinnacle™ DayCab is a versatile workhorse purpose-built to power your regional hauls. Like all Pinnacles, the DayCab combines productivity, reliability, low cost of ownership and fuel economy into a road-eating machine.

Highly customizable

No matter your haul, Mack makes it easy to optimize your Pinnacle DayCab for anything the job demands.

Chassis configuration

Pinnacle DayCab's chassis is designed to provide 50-degree wheel cuts. This saves you the grief and fatigue that come from ineffectively maneuvering tight spots.

Fitted frame

Rely on the right size frame to save weight and increase fuel economy. Mack delivers lighter, stronger frames that are made to fit your truck.

Bolted strength

Like all of our trucks, Pinnacle DayCabs are built strong to boost owner satisfaction. Mack uses Huck bolts to increase reliability and reduce rattles and squeaks.

Unstoppable stability

Mack is dedicated to ensuring your safety on the road. Your truck's low center of gravity spreads weight across all four corners to keep your cab balanced. At the same time, our Mack Roll Stability Advantage by Bendix and exceptional brakes (including available air disc brakes) keep you in total control on the mean streets.

Axle configurations

Available in single, tandem and tri-axle configurations, Pinnacle DayCabs can be customized with multiple drive and auxiliary axle combinations.

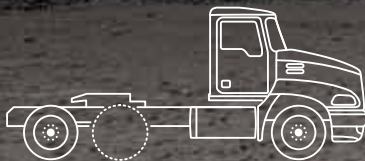

Axle Back



Axle Forward



Pinnacle Rawhide Edition

In the Pinnacle™ Rawhide® Edition, every haul delivers confidence. Outfitted to impress, this truck features stainless steel and leather stylings that will make you the envy of the road. The Rawhide Edition is available on the DayCab and 60- and 70-inch mid-rise Sleeper axle forward models.

Bright finishes

From your truck's grille to handles to 7-inch stainless bullhorn stacks, Rawhide boasts an abundance of brilliance.

Steering wheel

A leather grip, brushed chrome Mack horn cap and bright chrome spokes ensure that you steer around any obstacles in style.

Deluxe dash

Your Rawhide instrument panel is designed with desired function and form. Not only does it sport a Co-Pilot™ driver display, its brushed nickel with chrome gauge bezels give a strong, precise look.

Tailor-made mirrors

Never look at the road the same way again. Rawhide has bold, Bulldog®-style, heated, motorized and illuminated mirrors with integrated convex.

Take on the elements

Don't just brave the elements; beat them with Rawhide's stainless steel, 13-inch-deep exterior sun visor and quad trumpet air horns equipped with snow shields.



Ride in style.

Mack works hard to create some of trucking's most enviable interiors. When you ride in a comfortable Pinnacle™ cabin, you're given a trio of options for your trim: Genuine, Custom and Grand Touring. With diamond plate fabric and classic gunmetal gray styling, you can build a cab that's as unique as you are. And the Rawhide® package sets the standard for everyone else.

Pinnacle Series

GENUINE

Leather

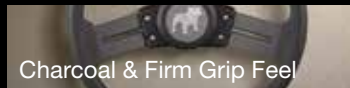

CUSTOM

Diamond Plate Cloth

Leather

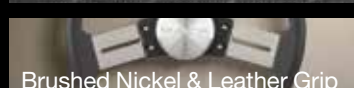
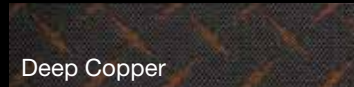

GRAND TOURING

Vinyl Button Tuck

Pleated Ultraleather™

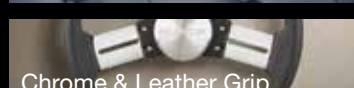

Pinnacle Rawhide Edition

RAWHIDE

Ultraleather™ Button Tuck

Two-Tone Leather

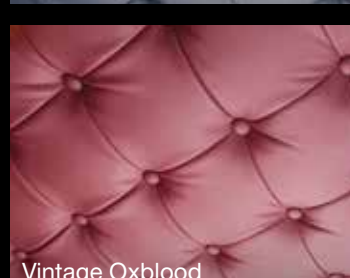

Find unmatched function.

Keep command of the open road in the Mack® cab that's made to keep you moving forward. Prepare to enhance efficiency, increase comfort and make the driver very happy with Pinnacle's ergonomic design.

INTERIOR ENVIRONMENT

The interior of each Pinnacle surrounds you with a quiet and comfortable environment. Interior lighting offers generous amounts of task and all-purpose lighting. Visibility is enhanced by a low hood profile, large windshield area and visibility doors.



CO-PILOT™ SYSTEM

Mack's easy-to-read Co-Pilot display allows you to move through 50 screens of real-time information, add specialized features and set the industry standard.



INSTRUMENT CLUSTER

With integrated gauge warning lamps, an engine oil temperature gauge, a voltmeter and a water-in-fuel indicator, your Pinnacle keeps an eye on the details so you can watch the road.



STEERING COLUMN

Our tilt/telescopic steering column provides infinite opportunities to achieve maximum driver comfort. Press the quick-release foot pedal to adjust your wheel and improve the visibility of your dash.

Higher standards. Lower emissions.

MACK® MP®7 ENGINE

The 11-liter MP7 engine is built for optimal fuel efficiency. This lightweight engine has evolved to run even cleaner. It emits less CO₂ than ever before while maintaining an HP range from 325 to 425 HP and torque ratings from 1,260–1,560 lb.-ft.

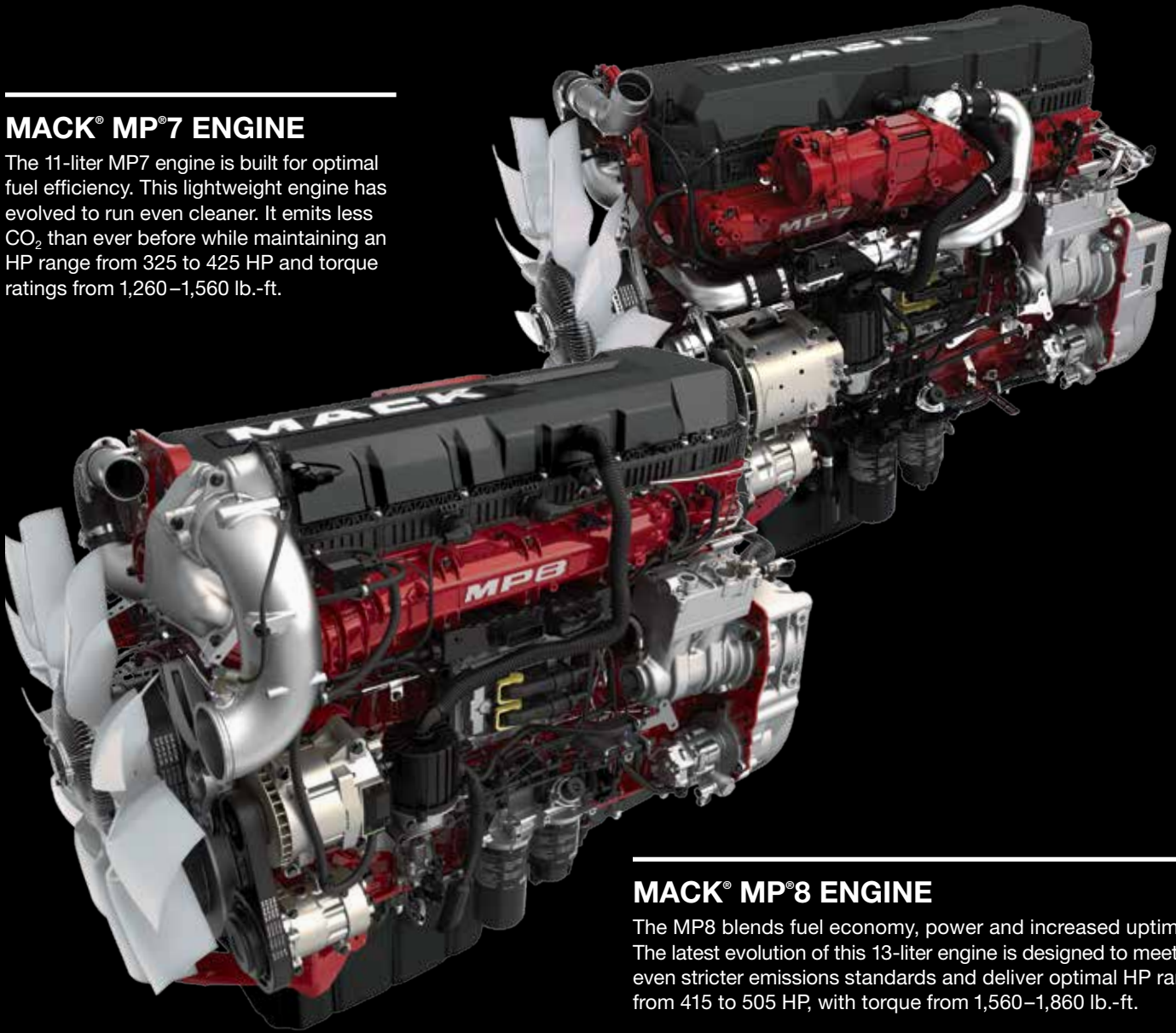

MACK® MP®8 ENGINE

The MP8 blends fuel economy, power and increased uptime. The latest evolution of this 13-liter engine is designed to meet even stricter emissions standards and deliver optimal HP range from 415 to 505 HP, with torque from 1,560–1,860 lb.-ft.

Turbocompound

Our MP8 Turbocompound engines incorporate a turbine to extract energy from exhaust gases that would otherwise be lost as heat and convert that energy to additional torque on the crankshaft, improving overall engine efficiency. (Available 2017)

Keep your standards high and emissions low. This next evolution of Mack MP engines is purposefully designed to provide the power and fuel economy your truck needs while meeting new, even stricter emissions standards.

MACK® WAVE PISTON

Mack's innovative Wave piston delivers a 2 percent improvement in fuel economy and a 90 percent reduction in soot. The design of the piston's bowl enables more complete fuel combustion by mixing air and fuel better than standard piston designs. It's a small change with major results.

Combustion chamber burn patterns



Standard piston combustion efficiency



Mack Wave piston combustion efficiency



MACK® CLEARTECH™ ONE

Mack knows emissions control systems, so we took ours one step further to optimize the overall package—and the result is ClearTech One. This new and improved exhaust aftertreatment system (EATS) is lighter and takes up less space, which saves fuel and money while improving flexibility. And it continues our tradition of low maintenance, increased uptime and lower total cost of ownership—areas where Mack excels.

Integrated powertrain?

Try integrated everything.

It's one thing to invent the integrated powertrain. We did that more than 100 years ago, and today our revolutionary Pedigree™ Powertrain sets the gold standard.



MP® Engine Series

With muscle, torque and great fuel economy, Mack MP engines conquer the workday, mile after mile.

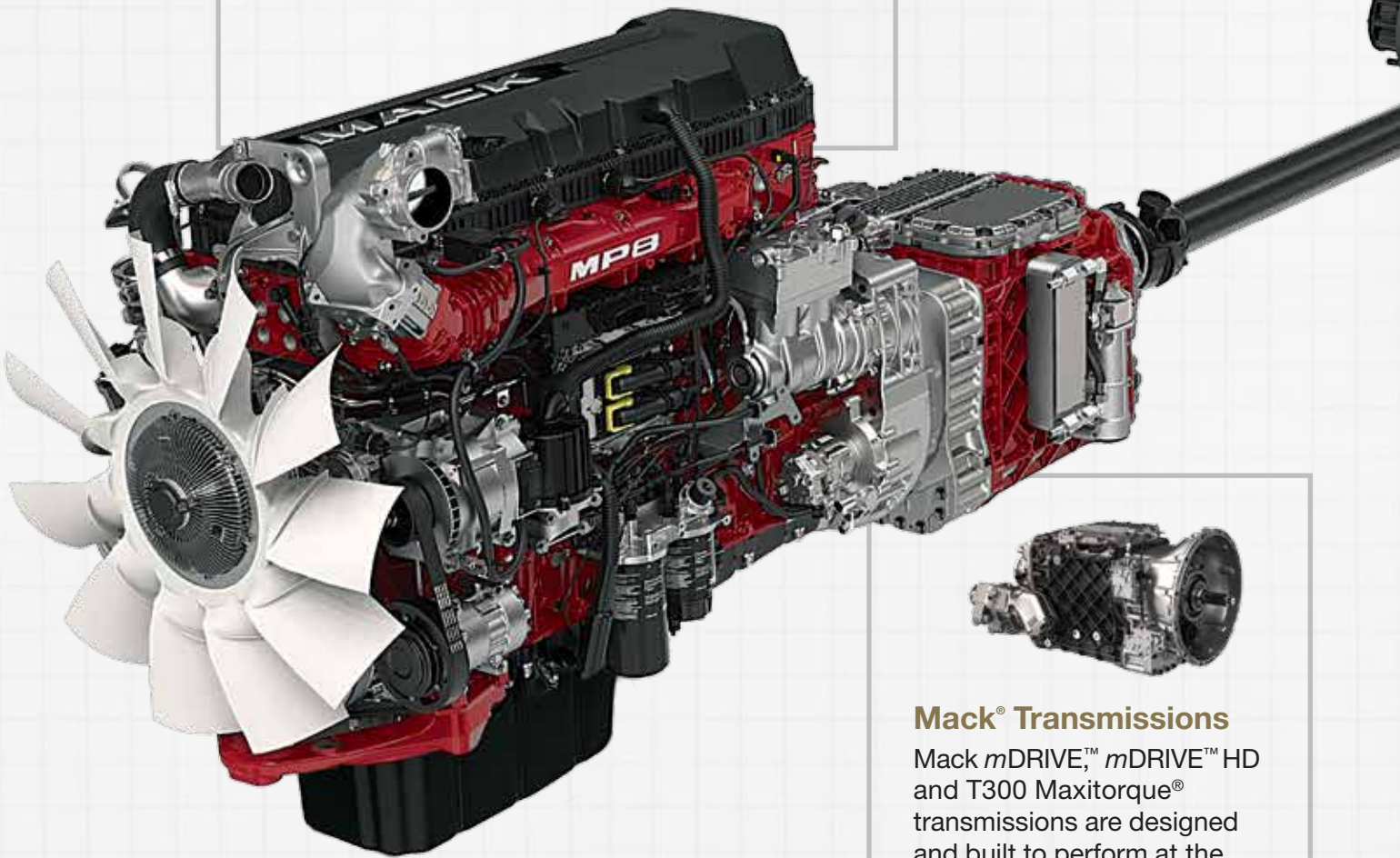

Mack® Transmissions

Mack *mDRIVE*™, *mDRIVE*™ HD and T300 Maxitorque® transmissions are designed and built to perform at the highest level in the most demanding conditions, just like the rest of the truck.



Mack® Axles

Mack axles and carriers are engineered to handle long hauls and the relentless punishment of the road.



Mack® Suspensions

We've engineered Mack suspensions for reliability and outstanding performance, no matter where they go. Which, with a Mack truck, can be almost anywhere.



Now, we've gone ahead and integrated the whole truck operating experience. From financing to service to 24/7 support, Mack has taken uptime and productivity to a whole new level.



Mack® Electronics

Featuring proven V-MAC® IV electronics, Mack makes it easier to work the way you want. Effortlessly manage your truck and engine, so you save on fuel and boost your bottom line.

Uptime Solutions

We work to deliver legendary Mack parts and services with our Uptime Solutions. Spend less time in the shop and more time on-site.



Automatically shift your thinking.

Make way for the two-pedal automated manual transmission that maximizes driver productivity and helps you boost your business with better fuel economy. The Mack® *mDRIVE*® is built for Pinnacle™ trucks to make highway hauling easier, safer and smarter.



SMOOTHEST SHIFTING ON THE ROAD

There's no clutch pedal. The gearshift is operated by an intelligent shift pad module and managed by sophisticated electronics. Mack *mDRIVE* delivers smooth shifts every time and can be operated by more drivers with less training than a traditional manual transmission.

ADVANCED TECHNOLOGY

Featuring innovative software and a network of sensors, *mDRIVE* continuously monitors changes in grade (both up and down), vehicle speed, throttle position, acceleration, torque demand and combined vehicle weight. With the engine and transmission in constant communication, there's no compromise.

INCREASED UPTIME

Mack *mDRIVE* automatically selects the best gear for optimized fuel economy at the desired road speed. This puts less stress on the driveline for longer life and less wear. Based on proven technology, this transmission requires minimal service and significantly reduced maintenance.

Weighs less. Carries more.

Roll over your toughest challenges. This heavy-duty automated manual transmission is available with an extended range of gears—including 12-, 13- and 14-speed versions—and offers up to 2,060 lb.-ft. of torque with horsepower ratings from 325 to 605 HP.

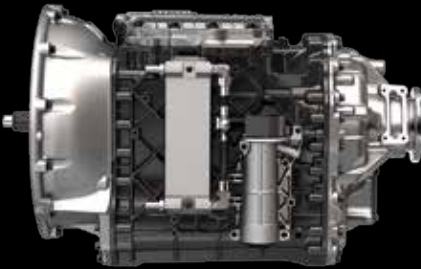

Increased productivity

The *mDRIVE HD* is offered with additional low ratios so that drivers are more easily able to adapt to whatever the job demands, allowing for increased productivity and performance.

Lighter than the competition

Even though *mDRIVE HD* is built strong, it's hundreds of pounds less than competitors, so you can ditch the dead weight and increase your payload.

Shift to a higher standard.

The Mack Maxitorque ES transmission is a rugged competitor. It features the industry's only triple countershaft design, offers a one-piece aluminum case and boasts the most PTO mounting options out there.

Purposeful power

This transmission delivers the desired torque to provide instantaneous pulling power to match the demands of the most severe roads.

Smooth shifting

It features a shift rail profile and light-touch design that allow for smooth transitions in and out of neutral with each shift. And because it's so smooth, drivers experience increased comfort.

Unmatched maneuverability

It offers lo and lo-lo ratios for exceptional maneuverability and slow speed control. Plus, our exclusive, shiftable, multi-speed reverse provides advanced precision.

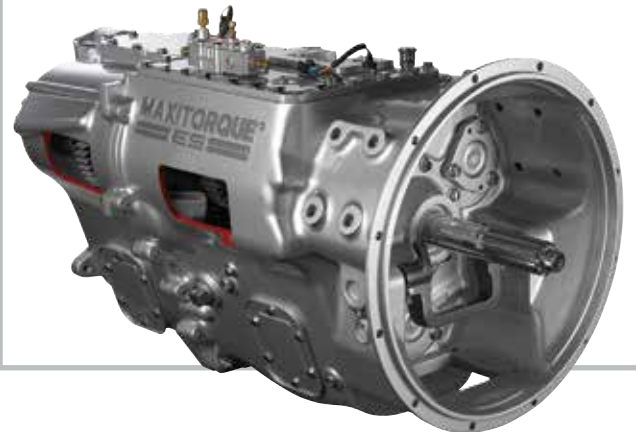

Cruise into complete control.

Mack's Predictive Cruise Control combines the Mack® *mDRIVE*® transmission and GPS with a system that learns on the go. It tracks, memorizes and stores routes so that next time you travel those roads, your truck knows exactly what to do. This makes your job easier and your day faster, more productive and more efficient.

INCREASED FUEL SAVINGS

When you drive a memorized route, Predictive Cruise Control is able to use its knowledge of the road's topography to adjust vehicle speed, engine torque and gear, reducing fuel consumption by up to 1 percent per drive cycle.

IMPROVED SAFETY

Predictive Cruise Control takes the reins when it comes to managing terrain, allowing drivers to focus on the conditions around them.

SMOOTHER DRIVE

Predictive Cruise Control knows what hills to expect, and when to expect them. It's prepared to engage the right gears at the right times so that your truck—and entire trip—runs more smoothly.

OPTIMIZED CONTROL FOR ANY GRADE



Before the climb

To gain momentum, Predictive Cruise Control increases speed when it knows a hill is coming.

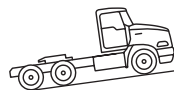

During the climb

It applies stored knowledge to avoid unnecessary downshifts for a smoother crest that uses less fuel.



On the crest

It prevents unnecessary acceleration at the top of the hill.



Before the downhill

The driveline temporarily disengages, allowing the truck to roll—minimizing fuel consumption.

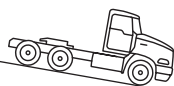

On the downhill

It knows when the grade ends, so it can gently apply the engine brake to control speed.

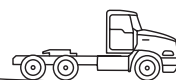

In the hollows

For downhills that become immediate uphills, it allows the truck to roll, gain momentum and climb with less effort.

MP®8 505C ENGINE FROM MACK

Flattens mountains, raises eyebrows.

With 505 HP packed into 13 liters and 1,860 lb.-ft. of torque any time you need it, Pinnacle™ is ready. For what, you ask? Whatever you've got in mind, that's what.

MAXICRUISE™

MaxiCruise delivers peak power whenever you need it across a broad RPM range, with up to 505 HP available. You get power and performance in one package to handle the challenges you face every day. Those steep passes and grades? Flattened. Heavier loads? Lightened. Along with the MP8 engine itself, which weighs almost 300 pounds less than competing 15-liter engines. And consider your fuel economy—because it's about to get a lot better. It's okay to be surprised.



Pump savings back into your business.

Mack takes fuel savings seriously. That's why we've designed our Super Econodyne® package to benefit your bottom line. And it delivers. The fully integrated package provides 3.5 percent better fuel economy than similarly spec'd vehicles. Because whether you're an owner-operator or managing an entire fleet, every drop counts.

mDRIVE™

Controlled by sophisticated electronics, mDRIVE monitors changes in grade, throttle position, torque demand and combined vehicle weight. Its industry-leading two-speed reverse does a better job controlling road and engine speeds for more efficient fuel use.

C125 AXLES

The Super Econodyne package is made up of Mack proprietary components, and the C125 axles are no exception. They have a 2.66:1 ratio, and the C125 drive axles offer an additional 1.5 percent fuel economy improvement.

MP®8-445SE ENGINE

The MP8-445SE helps Super Econodyne deliver industry-leading fuel efficiency without sacrificing power or performance. This engine provides 445 HP and up to 1,860 lb.-ft. of torque.

MP®7-425SE ENGINE

The MP7-425SE delivers all the fuel-saving virtues of the Super Econodyne rating in a smaller and lighter 11-liter package for weight-sensitive applications, with up to 1,560 lb.-ft. of torque.



Axles and suspensions provide the foundation for Mack's reputation of rugged reliability. They offer increased durability for a smoother ride, because the only thing you should feel on a cross-country haul is complete control.

Mack® suspensions offer improved stability, fuel economy and greater return on investment than the competition. Through integrated design and engineering, Mack continues to raise the performance bar for highway trucks with its Twin Y,[™] 6x2 and *mRIDE* suspensions.

Tough enough for the roughest roads.



MACK® AXLES

Proprietary Mack axles provide greater performance on the most demanding jobs. Our C125/126, C150/151 and 200 series axle carriers deliver great fuel economy and utmost reliability.



MACK PINNACLE™ 6x2 WITH LIFTABLE PUSHER AXLE

The 6x2 suspension with Liftable Pusher Axle for the Mack Pinnacle delivers improved fuel economy and lighter weight for regional, bulk, tanker and liquid hauls. Compared to current 6x4 and 6x2 configurations, it distributes weight more evenly, saves up to 300 pounds, has 3 to 5 percent better fuel economy, increases tire life up to 20 percent and can lower related maintenance costs significantly. The Mack 6x2 with Liftable Pusher Axle also improves traction and delivers the ride you expect from Mack.



TWIN Y

The Mack Twin Y air suspension is the trucking industry's first suspension to utilize an innovative Y-shaped high-strength steel design. The Twin Y is up to 400 pounds lighter than other air suspensions, offering customers a significantly lighter weight option. In addition to cutting weight and saving fuel, the Twin Y delivers unmatched comfort and handling for highway customers desiring a smoother, more stable ride.

mRIDE

Mack delivers the next generation in spring suspensions with *mRIDE*. Lighter than the competition, this suspension offers drivers extreme articulation and constant ground contact for all wheels to maximize traction and offer improved stability. Shock absorbers dampen the reaction of the suspension, while parabolic springs bring flexibility for an easier ride in both loaded and unloaded conditions. Mack *mRIDE* is available on Pinnacle axle forward models.



**GuardDog® Connect,
your uptime ally.**

GuardDog Connect is Mack's real-time diagnostic and monitoring service that's always looking out for you wherever you are.

GuardDog provides 24/7 support, so if your truck demands immediate attention, our OneCall® customer center answers. A team of experienced technicians then identifies the exact issue and any repairs, while OneCall instructs the driver where to take the truck.

When the truck arrives, the dealer and technicians have all of the information they need to get right to work. That means you get out of the shop and back on the highway where you belong.

MACK® CONNECTED TRUCK





Drive toward a cleaner solution.

The same highway trucks that conquer steep grades and long hauls are also available with Mack Natural Gas. We have a long history with natural gas-powered vehicles, and integrating it into our Pinnacle™ Series provides yet another cost-effective way to help you do business.

COST SAVINGS

Savings That Add Up Fast

The Pinnacle Series models not only meet EPA and CARB emissions levels, they also set a new benchmark for lower vehicle lifecycle costs. The lower cost of natural gas saves fleets money with every mile they operate.

Uses Less Expensive Fuel

Because you're not subject to the volatility of foreign oil prices, you can expect lower prices at the pump and reduced costs over the lifecycle of your truck.

Reduces Foreign Oil Dependency

Natural gas is a readily available resource in North America, helping you reduce our dependency on foreign oil.

ENVIRONMENTAL BENEFIT

Lowers Greenhouse (CO₂) Emissions

Today's emission standards are strict, but these trucks are up to the challenge, meeting the standards while reducing greenhouse gas intensity per unit produced by more than 43 percent.

Cuts Carbon Footprint

Not only are you saving money and complying with government-issued emissions standards, you're also doing your part to improve the environment by reducing your company's carbon footprint.

Multiple Natural Gas Fuels

The Pinnacle Series is capable of operating on compressed or liquid natural gas (CNG, LNG) and even landfill gas (LFG) or hydrogen compressed natural gas (HCNG) that meets Cummins minimum fuel quality specifications.





**Everything your Mack needs.
Every place you need it.
America's truck knows
no boundaries.**

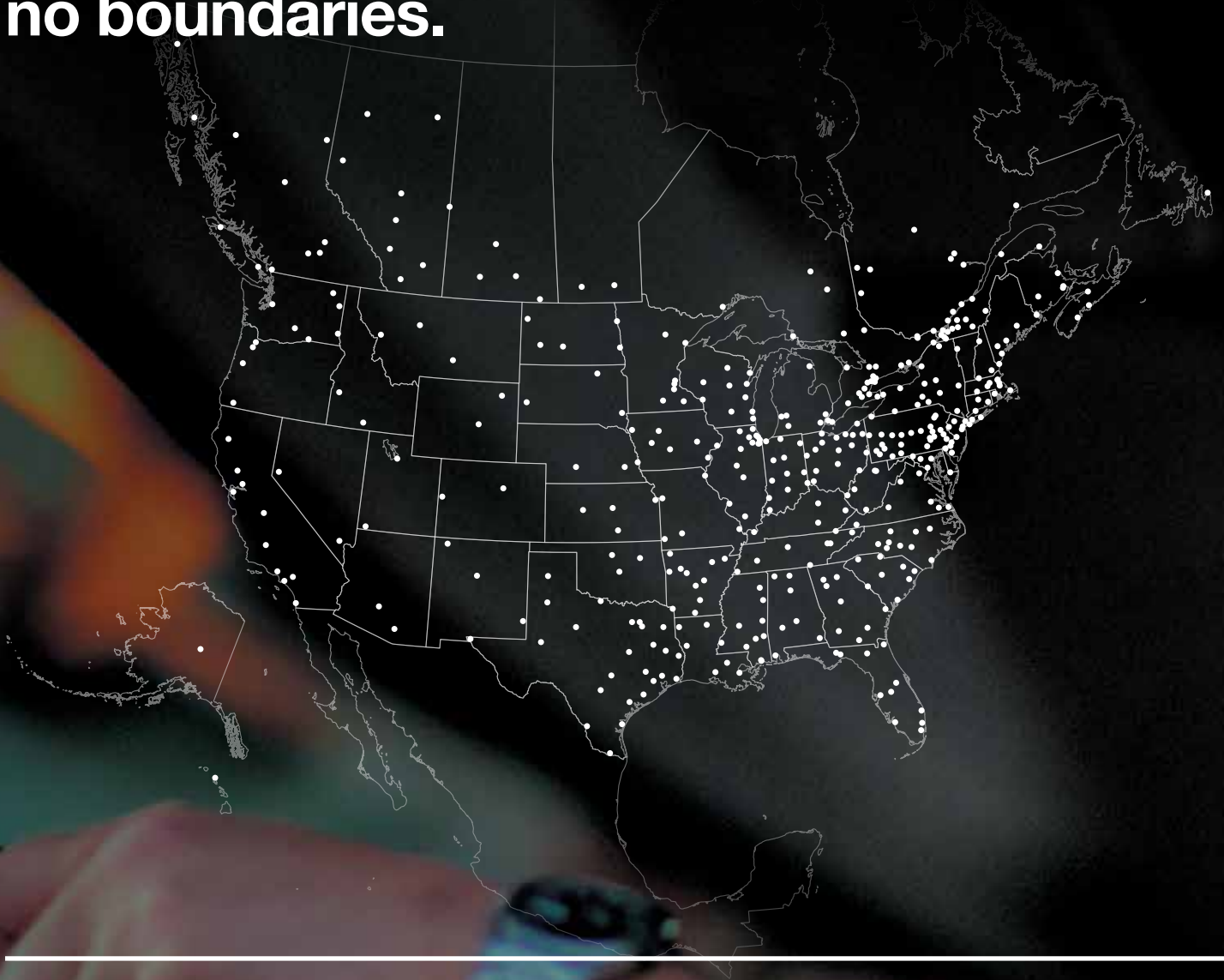

NETWORK SUPPORT

Mack Dealer Network

Every Mack is supported by more than 400 authorized dealer and parts and service locations. These dedicated locations have invested in a level of service fit for a Mack truck—ensuring that you are greeted by knowledgeable staff, that you get in and out quickly and that your truck gets fixed right the first time.

Parts Purchasing

Mack makes it easy to get the right parts at the right time. From parts programs for entire fleets to a web-based program that provides 24/7 access to parts, we make sure you have access to the parts you need, when you need them.

Customer Training

When you purchase a truck from Mack, Mack Trucks Academy offers best-in-class training for your shop staff to improve uptime and your bottom line. Choose from instructor-led or online training to get your staff up to speed.



UPTIME SOLUTIONS

GuardDog® Connect

GuardDog Connect monitors your vehicle's performance the entire time it's operating to enable quick diagnosis of issues, schedule repairs and order parts—all while the truck is still on the road. With GuardDog Connect, you're always connected to a 24/7 network of support staff and repair centers, so you stay on schedule.

OneCall® (1-800-866-1177)

Mack® OneCall provides 24/7 support for your truck. It combines an unparalleled customer support network with a state-of-the-art Uptime Center to bring the experts you need together under one roof.

ASIST

Mack ASIST is a web-based system that assembles consistent, complete and professional estimates of service recommendations, regardless of which dealer in the Mack Network performs the service. ASIST gives you, the dealer and Uptime Center staff access to all information, getting you back on the road faster.

Diagnostic Tools

Mack's easy-to-use, PC-based diagnostic software gives you access to the information you need. From quick diagnostics to EPA emission data and key metrics for Mack trucks with Mack engines, you can monitor your fleet in real time.



Your truck should come on your terms.

Take control with Mack's complete business services.

From financing to premium maintenance packages, Mack has what you need to get, and keep, your truck on the road.

MACK FINANCIAL SERVICES

Mack offers comprehensive financial services that include customized loans, leases and payment plans. You choose the terms, then Mack comes up with the payment plan and coverage that works for you, so you can build your business.

FLEET MANAGEMENT SERVICES

Mack's unique suite of offerings makes fleet management fast and easy. Mack partners with best-in-class software providers and telematics services to deliver the intelligent tools you need to manage your fleet.

MACK LEASING SYSTEM

Mack offers full-service leasing and rental services backed by our growing association of MLS dealer members. Whether you're looking to lease your fleet, rent a truck or outsource your maintenance, Mack has a variety of solutions to meet your needs.

PREMIUM MAINTENANCE PLANS

Mack takes the worry and hassle out of maintenance with premium plans that provide nationwide maintenance coverage at any authorized Mack dealer location. Select a plan and pay upfront so that your truck's interval maintenance is covered—no payment or paperwork required.

WARRANTY AND PROTECTION PLANS

Mack offers the most flexible warranty program in the industry. Whether you need a standard warranty or a premium protection plan, Mack can customize a plan to meet your specific business requirements.

**MACK TRUCKS
ARE BORN TO GO
THE DISTANCE.**







1-800-922-MACK
MackTrucks.com

 facebook.com/MackTrucks

 twitter.com/MackTrucks

 youtube.com/MackTrucks

 linkedin.com/company/mack-trucks

 plus.google.com/+macktrucks/posts

BORN READY.