

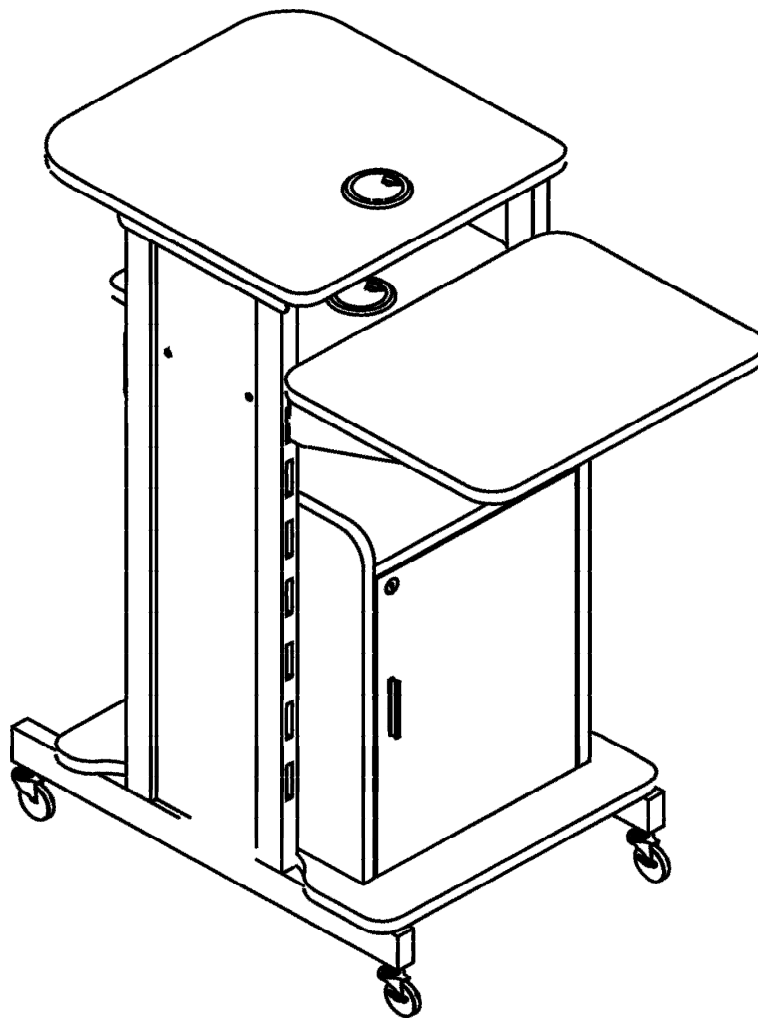

DELUXE PRESENTATION CART

PRODUCT HANDBOOK



MODEL # PRC 250

Dear Valued Customer,

Although extreme care goes into manufacturing and packing of this package, mistakes are possible. If you encounter any missing parts or difficulty in assembly, etc. please call our toll free customer service line at 1-800-261-4112 for courteous and immediate resolution to your problem.

Sincerely





Oklahoma Sound

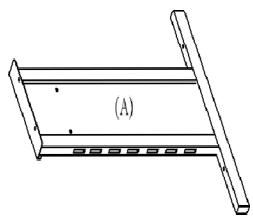
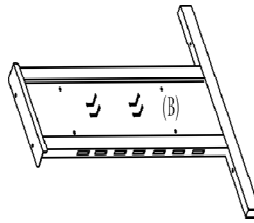
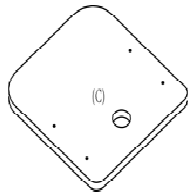
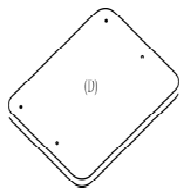
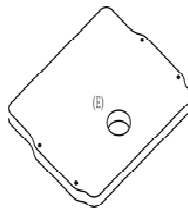
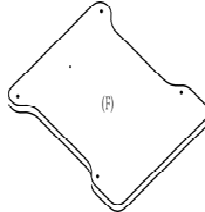
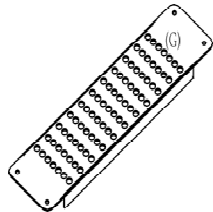
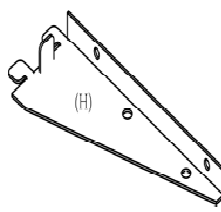
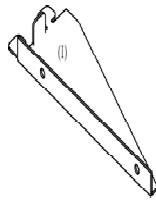
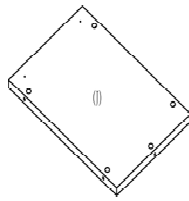

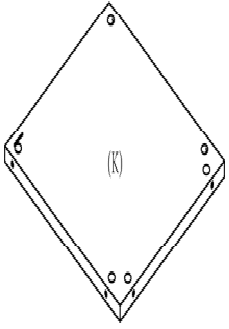
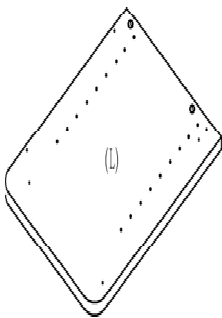
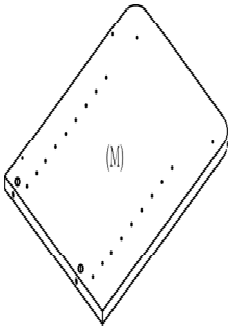
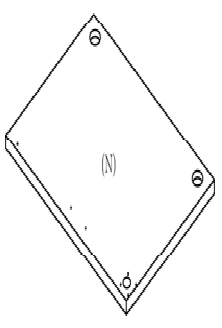
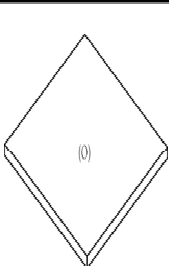
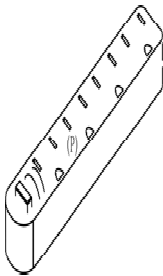
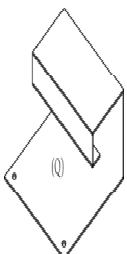

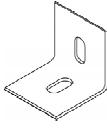
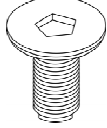

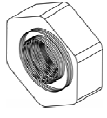
Manufactures Warranty

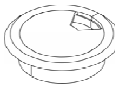
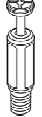
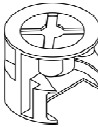
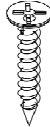
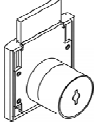
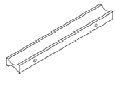
Our lecterns undergo the most rigid and exacting test for superior quality and performance before leaving our factory. Oklahoma Sound warrants this product to be free from defective material and workmanship on this unit for five years from the date of resale by an authorized Oklahoma Sound distributor. Oklahoma Sound will replace defective parts and repair malfunctioning products under this warranty when the defect occurs under normal installation and use, provided that the unit is returned to our factory via prepaid transportation after direct authorization and approval form Oklahoma Sound. This warranty provides that examination of the returned product must disclose in our judgment a manufacturing defect. This warranty does not extend to any product which has been subject to misuse, neglect, accident, improper installation or where the serial number has been removed if defective and is given in lieu of any other warranty implied or expressed and will not cover any damage.

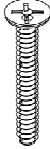
Parts List	
(A) 1PC	(B) 1PC
	
(C) 1PC	(D) 1PC
	
(E) 1PC	(F) 1PC
	
(G) 1PC	(H) 1PC
	
(I) 1PC	(J) 1PC
	

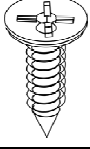
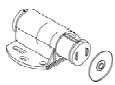
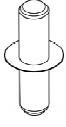
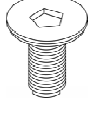
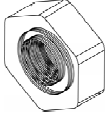
Parts List	
(K) 1PC	(L) 1PC
	
(M) 1PC	(N) 1PC
	
(O) 3PC	(P) 1PC
	
(Q) 1PC	
	

Hardware List					
(1)		4 pcs	(2)		20 pcs
(3)		4 pcs	(4)		4 pcs
(5)		2 pcs	(6)		2 pcs
(7)		2 pcs	(8)		15 pcs
(9)		15 pcs	(10)		4 pcs
(11)		1 pcs	(12)		1 pcs

Hardware List					
(13)		2 pcs	(14)		2 pcs
(15)		8 pcs	(16)		1 pcs
(17)		12 pcs	(18)		2 pcs
(19)		2 pcs	(20)		1 pcs
(21)		1 pcs	(22)		1 pcs

Before you begin the assembly open all the panels from their individual wrapping to identify the panels properly . Be sure to open them in a way that will not scratch the panels.

Step 1:

- a) Begin by taking surface panel #C and lay it on a clean, soft surface facing down with the holes facing upwards.
- b) Locate side panels #A and #B.
- c) Make sure that both panels are facing inwards with the slotted end of the side panel at the straight edge of panel #C as shown.
- d) Use four bolts #2, two for each panel, to secure the side panels to the surface panel as shown. Screw the two bolts through the holes on the top of the side panels and into the embedded T-nuts on panel #C.
- e) Use the provided hex key, part #20 to tighten the bolt in place.

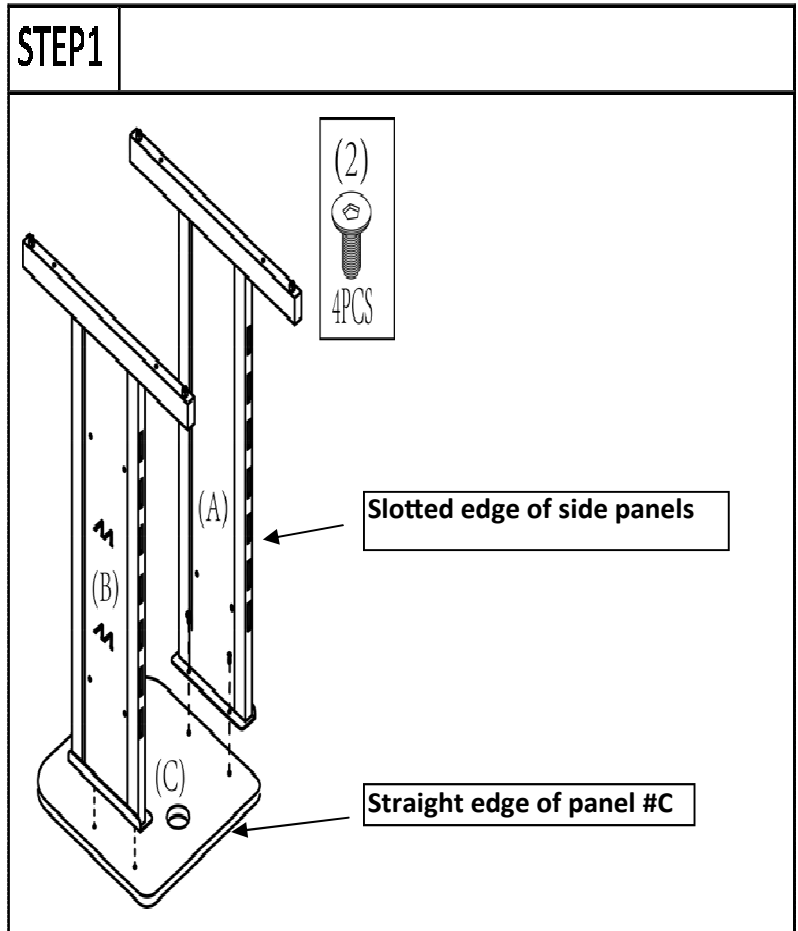

Step 2:

- a) Locate the projector shelf panel #E and lay it down on a clean surface facing down with the holes facing upwards.
- b) Attach four “L” brackets part #1 to the two sides of the panel as shown. Make sure that the vertical side is at the edge of the panel as shown.
- c) Use four bolts #2 to attach the brackets by inserting the bolt through the hole on the bracket and into the embedded T-nuts in the panel.
- d) Use the provided hex key, part #20 to tighten the bolt in place.

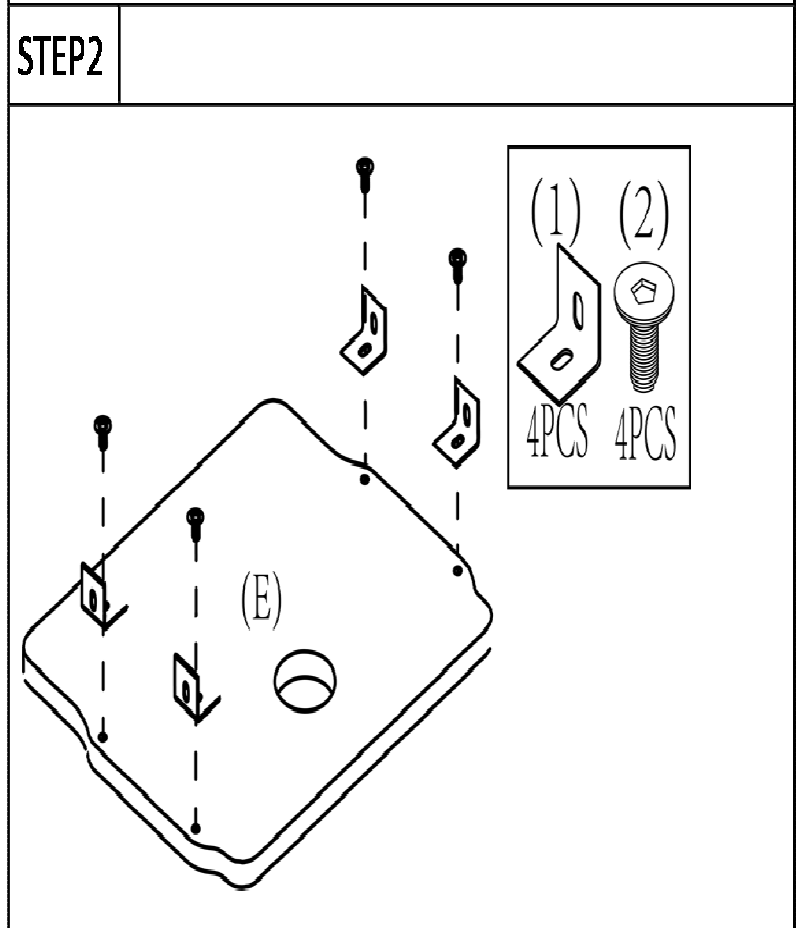

Step 3:

- a) Attach the projector shelf part #E to the unit by aligning the holes on the two “L” brackets on both sides of the shelf with the holes on both side panels #A and #B as shown.
- b) Make sure that the flush end of the projector shelf is aligned with the straight end of panel #C as shown.
- c) Once the holes on the brackets are aligned with the holes on the side panels, take four bolts #2 and thread them through the hole from the outside of the side panels and through the “L” bracket. Once the bolts are threaded all the way through, use four nuts part #4 to secure the bolt in place.
- d) Use the provided hex key, part #20 to tighten the bolt in place.

STEP3

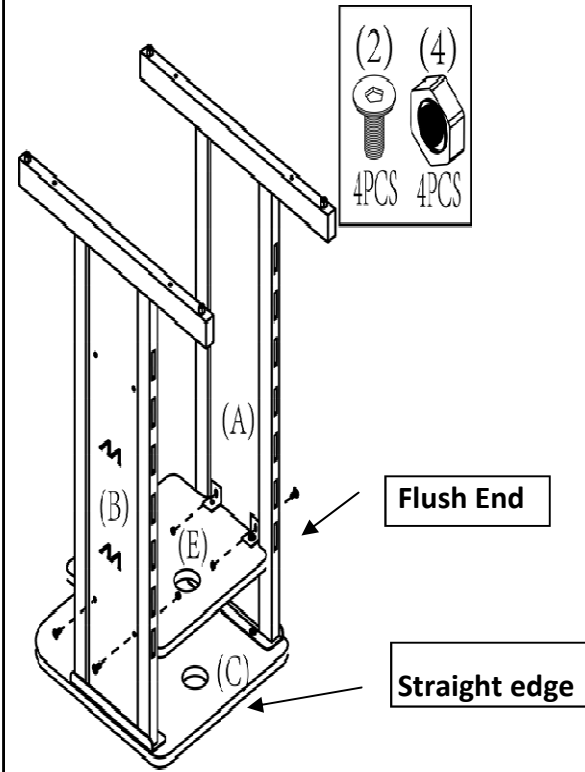

Step 4:

- a) Locate the base panel #F and slide it between the two side panels as shown. Lift the panel upwards until the bottom of the panel reaches the base of the side panels as shown. **The ends of panel #F should not protrude over the ends of the side panel.**
- b) The two holes on each of the side panels will line up with the embedded T-nuts on panel #F.
- c) Use four bolts #3 to attach the base panel #F by threading the bolts through the holes on the bottom of each side panel and into the embedded T-nuts in panel #F as shown.
- d) Tighten the bolts well so the panel is secured to the two side panels.
- e) Use the provided hex key to tighten the bolt in place.

STEP4

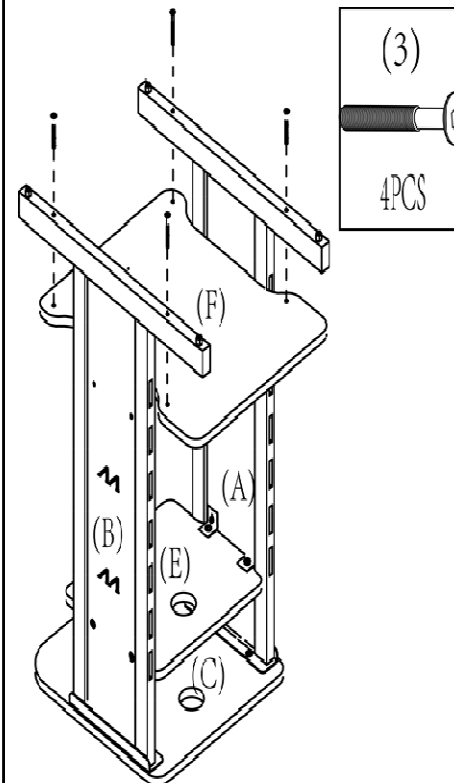

Step 5:

- a) Identify the four caster wheels, two locking part #6 and two non-locking, part #5.
- b) Be sure to attach the two locking casters #6 at the correct side of the unit as shown in the illustration for easier access while operating the cart.
- c) Thread the stems of the casters through the caster nuts located at each corner as shown.
- d) Use the open wrench part #21 to tighten the caster to the unit.
- e) Repeat this process to attach the two non-locking casters #5 into the holes on the other end of the side panels.

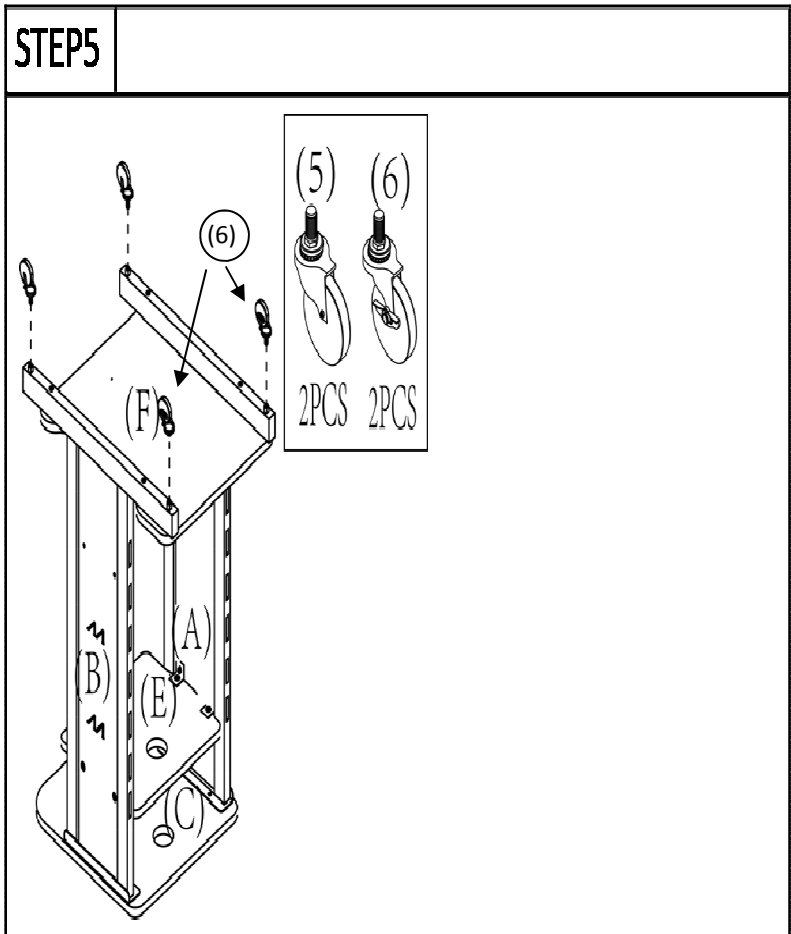

Step 6:

- a) Gently turn the cart right side up and tighten all the bolts and nuts attached in step #1 and #3.
- b) Lock the locking casters to prevent the unit from sliding during assembly.
- c) Identify the power cord winder part #Q and align the two holes on the corners with the two holes on the lower section of side panel #B.
- d) Once aligned, use two bolts #18 and two nuts #19 to secure the power cord winder in place by threading the bolt from the outside of the unit and securing it in place with the nut on the inside of the unit.
- e) Use a Phillips screw driver to tighten the screws in place.

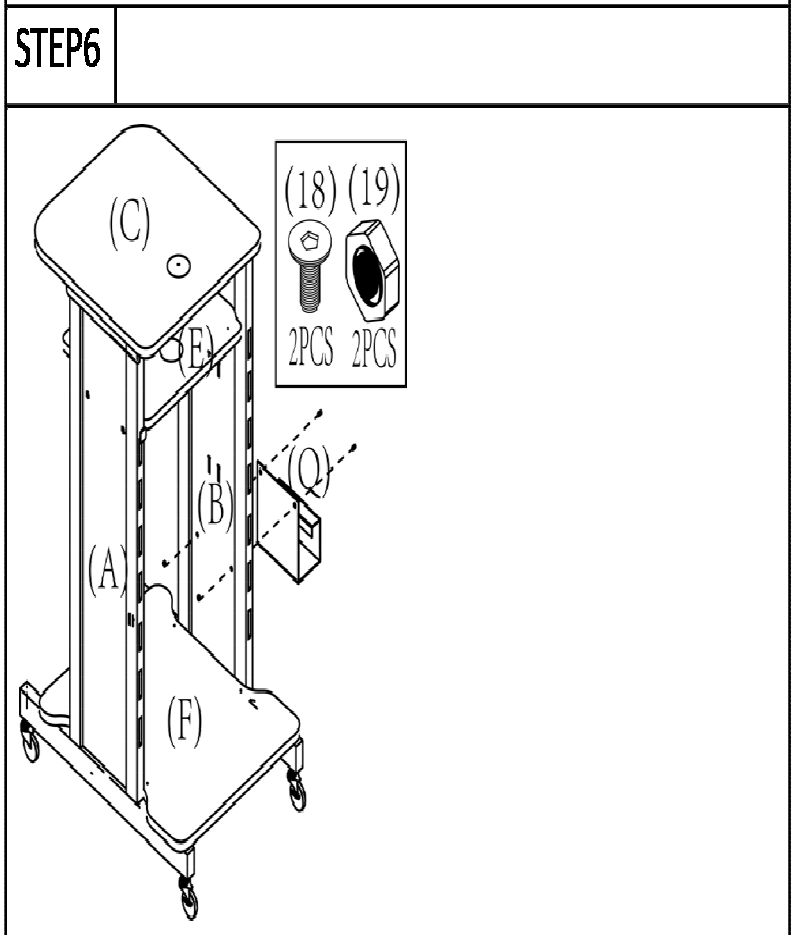

Step: 7

- Identify panel #D and lay it on a clean, soft surface facing down with the holes facing upwards.
- Locate the two supporting brackets #H and #I and lay them over the panel as shown. The two tabs at the end of the bracket should be at the edge of the panels as shown. The two brackets should be facing inwards as shown.
- Align the two holes on the brackets with the embedded t-nuts in the panel.
- Once they are aligned use four bolts #2, two for each bracket and thread them through the holes on the bracket and into the t-nuts.
- Use the hex key to tighten the bolts .
- To attach the adjustable shelf to your unit, align the two tabs on each bracket with the slots on the edge of each side panel. One aligned slip it in and gently push the shelf downwards to lock in place.

STEP7

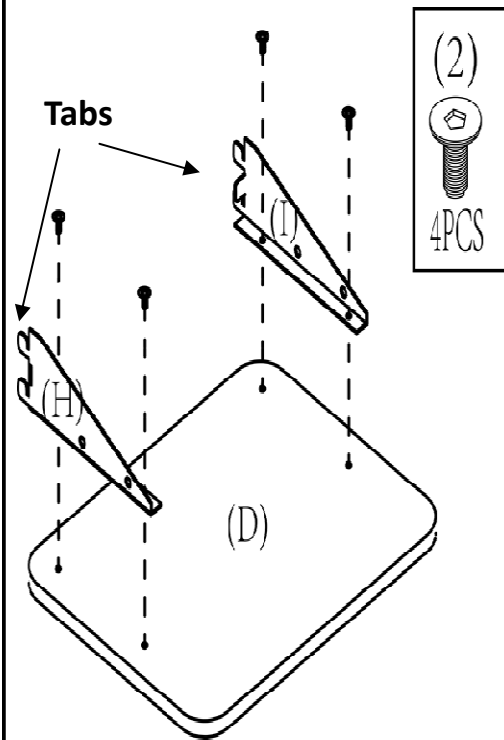

Step 8:

- Identify panels #J and #K and lay them down on a clean and soft surface with the holes facing upwards.
- Using a Phillips screwdriver insert two cam bolts #8 into the plastic inserts on panel #J .
- Insert five cam locks #9 into panel #J and six cam locks into panel #K.
- Important: Be sure to always insert the cam locks with the arrow facing the edge of the panel so the cam bolt can be inserted with ease.**

STEP8

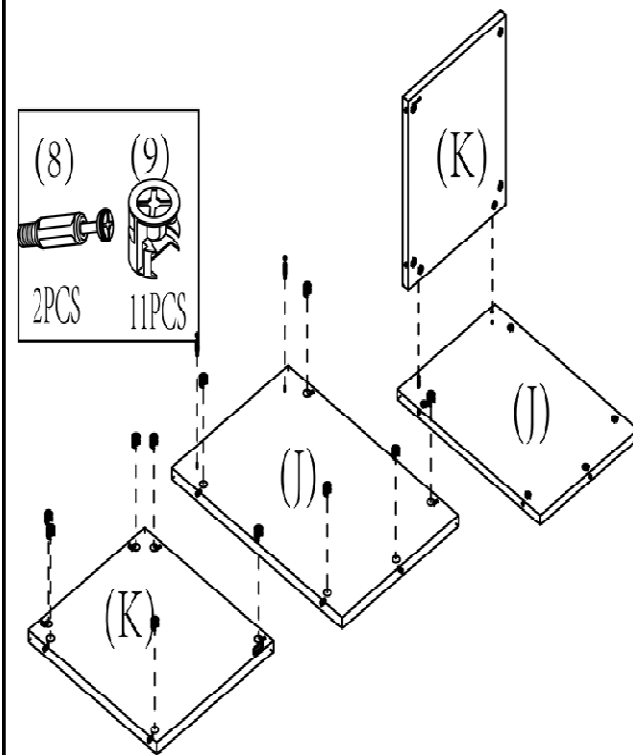

Assembly:

- Align the two cam bolts on panel #J with the two cam locks at the edge of panel #K as shown.
- Once the holes are aligned, lower panel #K so the cam bolts are inserted into the cam locks.
- Once panels #K and #J are flush, use a Phillips screw driver to turn the cam locks so the two panels lock together.
- Place these panels on the side for a future step.

Step 9:

9a) Identify panels #L and #M and place them on a clean, soft surface with the holes facing upwards.

Use a Phillips screwdriver to screw four cam bolts #8 into the plastic inserts in panel #L and four cam bolts into the plastic inserts on panel #M as shown.

9b) Insert two cam locks #9 into the pre-drilled holes at the bottom of panel #L and two into the holes on the bottom of panel #M.

There is also one extra hole on each panel for the down on the side of panel J to be inserted into when assembling the cabinet..

9c) Identify the two female hinges of parts #14.



Align the hole on each side of the hinge with the pre-drilled holes on panel #M, located right above and directly below the row of shelf support holes on the panel as shown.

Be sure that the open end of the hinge is facing the edge of the panel as shown.

Using a Phillips screw driver, screw two screws #15, through the holes on the side of each hinge into the holes on the panels.

9d) Identify the door catch part #16.

Align the round holes on the side of the door catch with the two holes on the bottom corner of panel #L.

Be sure that the magnetic end of the barrel is facing the edge of the panel.

Once the holes are aligned, use a Phillips screw driver to screw two screws #22 to attach the door catch to the panel.

Step 10:

- a) Attach the two side panels #L and #M with the back panel #J and top panel #K.
- b) Align the four cam bolts on the face of panel #L and #M with the four cam lock holes on the edge of panels #J and #K, two on panel #J and two #K as shown.
- c) Once all the bolts are aligned and inserted so that panel #L is flush with panels #J and #K, use a Philips screwdriver to tighten the cam locks so the panels will lock together.
- d) The dowel at the two edges of panel #J will insert into the holes on panel #L and #M
- e) Repeat the same process to attach panel #M to the right side of the cabinet.

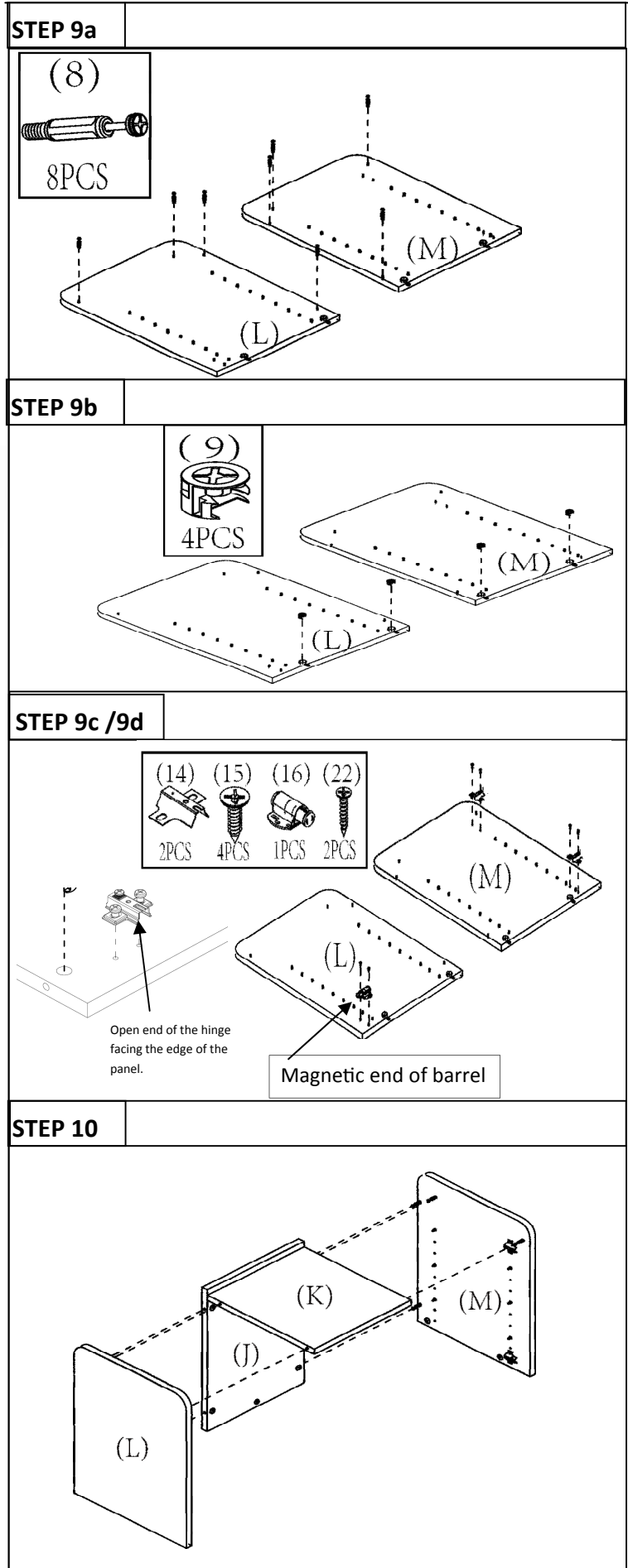

Step 11:

- Use a Phillips screwdriver to Insert five cam bolts #8 to the plastic inserts in the base panel #F as shown. (Two on each side and one in the back)
- Once the cam bolts are tightly screwed in, lift the cabinet (panels #L,M,J,K) over the base panel to align the five cam bolts with the five cam lock holes located on the bottom of the cabinet walls; Two on panel #L ,two on panel #M and one in the middle of panel #J .
- Once the cam bolts and cam locks are aligned, lower the cabinet so the bolts are inserted into the locks. Once the bolts are inserted into the locks and the cabinet is flush with the base panel, use a Phillips screwdriver to tighten the cam locks, locking the cabinet to the base panel.

STEP 11

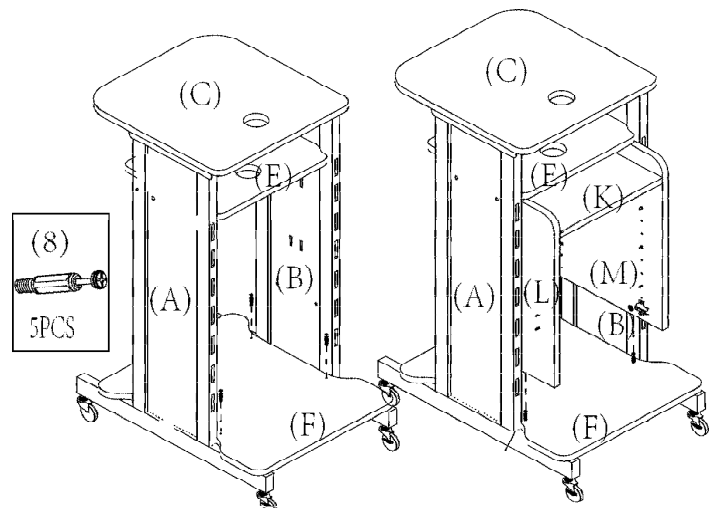

Step 12:

- Identify the door panel #N and lay it down on a clean, soft surface with the white side facing up.
- Begin by identifying the two male hinges part #14. The base of the hinges will fit into the two routed out holes on the edge of panel #N as shown.
- On each side of the hinge there is a hole that will align with a pre-drilled hole on the panel.
- Make sure that the arm of the hinge is facing over the edge of the panel as shown.
- Use the four screws #15 to screw the hinges in place.

STEP 12

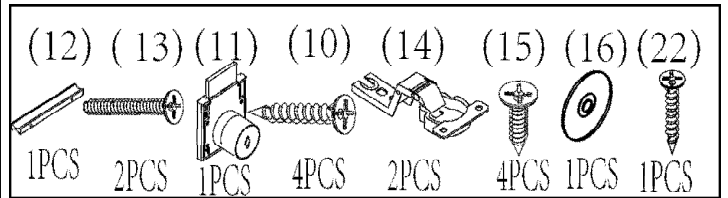

Lock Assembly

- Locate the lock part #11 and insert the barrel of the lock through the large hole on the top corner of the panel.
- Make sure that the tongue of the lock is facing the edge of the panel, pointing upwards as shown. The four holes on the lock assembly will match four pre-drilled holes on the panel.
- Use a Phillips screwdriver to attach the lock assembly to the panel with four screws #10.
- Place the black ring around the barrel of the lock from the outside of the panel with the spikes slipping between the barrel and the panel.
- Locate the round metal door catch plate part #16 and attach it to the door at the corner of panel #N using a Phillips screw driver and screw #22.
- Next, locate the door handle part #12 and place it on the outside of the panel over the two small pre-drilled holes.
- Once the holes on the door aligned with the holes on the handle, use two screws #13 and screw the handle to the door.

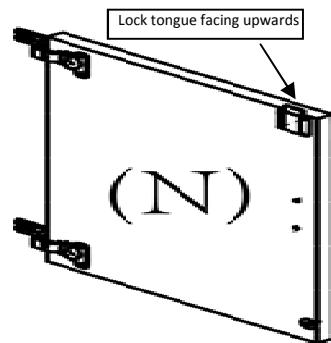
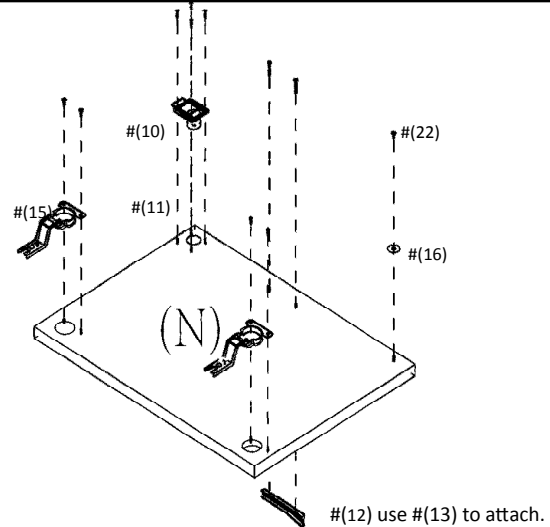

- The two screws should be threaded from the inside of the door using a Phillips screwdriver to tighten the screws with the handle in place.

Step 13:

- Take the assembled door part #N and align the male hinges to the female part of the hinges that is located on the side wall of the cabinet (panel #M) as shown.
- Once aligned place the male hinge over the female end and slip the open end of the male hinge into the pre-attached screw on the female end.
- Once the two parts of the hinges are attached, tighten the pre-attached screws on each hinge to secure the two parts of the hinges together.
- Insert twelve shelf pins #17 to the inside of the cabinet at the desired height of the three adjustable shelves.
- Insert the three shelves panel #O into the cabinet to rest on the three levels of support pins.

STEP13

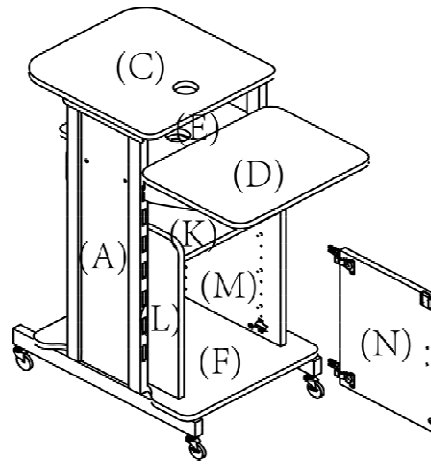

Step 14:

- Identify part #G and locate the four holes, two located at each side of the panel.
- Panel #G will be attached to the front of the unit right below the projector shelf #E as shown.
- On the edge of the two side panels right below the projector panel #E you will notice four holes, two on each side, which will correspond with the four holes on panel #G.
- Attach Panel #G using four bolts #2. Use the provided hex key to tighten all the bolts.

STEP14

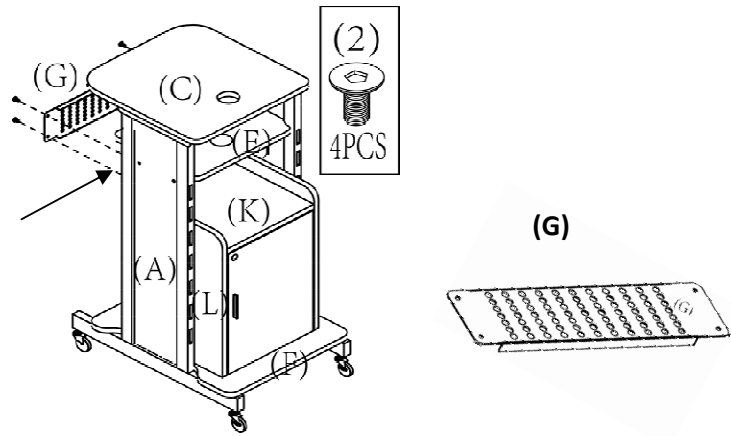

Step 15:

- Identify the two plastic grommets part #7 and insert one in the surface panel #C and one in the projector shelf #E.
- Identify the power strip part #P.
- The power strip is attached to the side panel above the power winder by aligning the slots on the back of the power strip to the metal tabs on the side panel above the winder part #Q.
- The power strip should be mounted with the cord coming out from the top of the strip.
- Slip the tabs into the grooves and pull gently downwards and the power strip will be secured in place.
- Proceed to wrap the cord around the cord winder part #Q to store it properly.

STEP 15

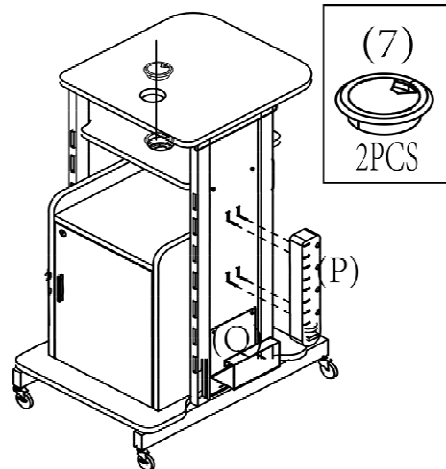

Congratulations!!! Your PRC 250 is now fully assembled!!

Other Sound and Non-Sound Lecterns from Oklahoma Sound

Model #WZD

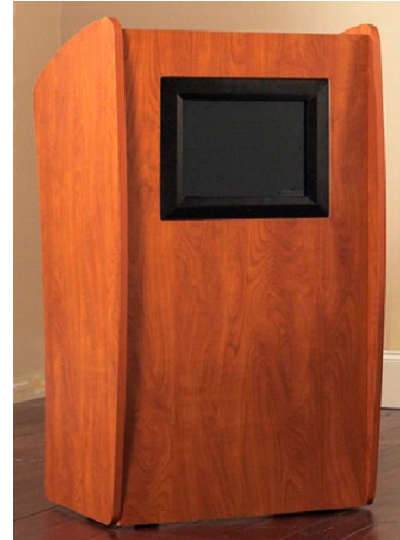

Model #612

Model #LSS



MODEL #111 PLS

Model #SCL



For these and other OS product please contact your dealer, or:

Oklahoma Sound

149 Entin Road, Clifton N.J. 07014 ♦ Tel : (973) 594-9000

www.oklahomasound.com ♦ info@oklahomasound.com