

VEXVE

Vexve X shut-off and balancing valves
instructions for installation, operation, adjustment
and maintenance

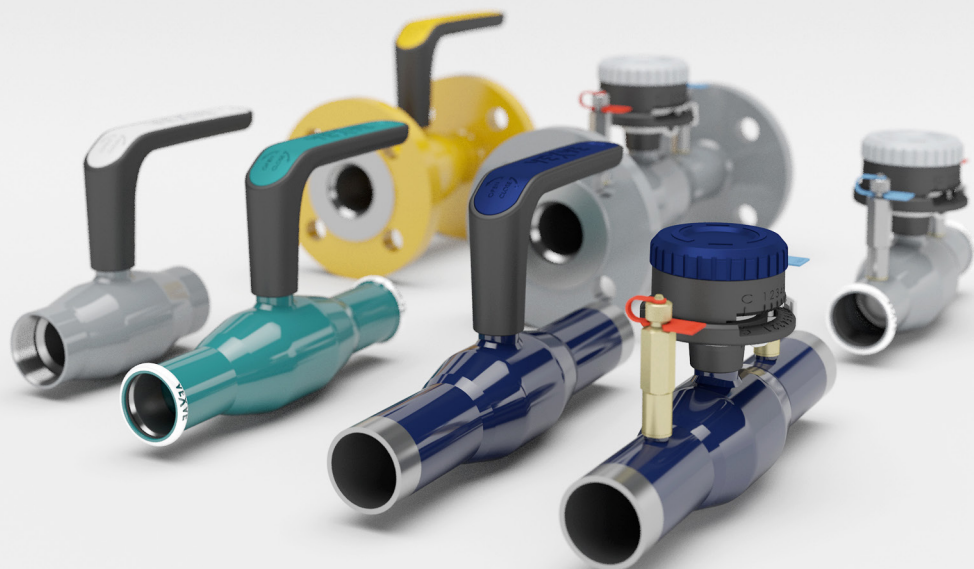

Contents

1. General	4
2. Identifying the valve	6
3. Reception of consignments and storage	7
4. Valve installation using different connection methods	8
4.1 Installing a valve with a welded connection	8
4.2 Installing a valve with flanges	10
4.3 Installing threaded valves	11
4.4 Compatibility of press fit valves and installation	12
4.4.1 Compatibility of press fit valves	12
4.4.2 Installation of press fit valves	12
4.4.3 Making a press fit connection	13
4.5 Minimum installation distances	15
4.6 Installation on the end of the pipe	16
4.7 Commissioning and pressure testing	16
4.8 Balancing valves	17
4.8.1 Determining the preset value for the balancing valve	17
4.8.2 Setting the preset values	18
4.8.3 Measuring the valve's flow rate	18
5. Maintenance	19
5.1 Replacing the O-ring in the X range of valves	20
6. Appendices	21
6.1 Structure of balancing valves < DN 50	21
6.2 Structure of shut-off valves < DN 50	22
6.3 Kv curves for balancing valves	23
6.4 Kv curves for shut-off valves	26
6.5 Kv values for shut-off valves	27
6.6 Coupling dimensions	27
6.7 Torque	27



Note:

read these instructions carefully and comply with them when installing, using and maintaining the valve.

These are general instructions, and they do not cover every possible usage condition. The manufacturer can provide further guidance on installing, using and maintaining the valve if required. If you are not sure whether the valve is suitable for the intended application, contact the manufacturer.

Vexve Oy reserves the right to change these instructions without notifying the customer.

Vexve Oy shall not be liable for loss or damage incurred due to the incorrect transportation, handling, installation, use or maintenance of the product.

Vexve Oy shall not be liable for loss or damage due to the presence of objects, particles or impurities that should not be in the system.

Warranty

See Vexve Oy's General Conditions of Sale for more information about the warranty.

The warranty covers manufacturing and material defects. The warranty does not cover damage incurred due to the incorrect installation, use, maintenance or storage of the product. Failure to follow these instructions may void the warranty. Defective products covered by the warranty should be returned to the manufacturer for investigation. Vexve Oy may grant a refund only when the product has been found to be defective.

The warranty conditions are set out in Vexve Oy's General Conditions of Sale, which are available from the manufacturer.

Warnings and symbols

Failure to observe the warnings and symbols may lead to severe personal injury or product damage. The people using the products must be familiar with the warnings and instructions.

To guarantee flawless, stable operation, the product must be transported, stored and installed correctly and commissioned carefully.

The following symbols are used in these instructions to draw the reader's attention to actions that are essential in order to guarantee safety and the correct use of the product.



Meaning of the NOTE symbol:

The NOTE symbol is used alongside actions that are essential in terms of the correct use of the product. Failure to observe this symbol may have damaging consequences.



Meaning of the WARNING symbol:

The WARNING symbol is used alongside actions that must be performed correctly in order to avoid severe personal injury or product damage.

1. General

The Vexve X range of shut-off and balancing valves is designed to optimise the shut-off and control of heating and cooling networks in buildings.

The steel shut-off and control valves are designed for clean media, such as oxygen-free water or water-glycol mixtures.

The stainless steel ball valves are suitable for many industrial systems with media such as process waters, ethanol, methanol, water-glycol mixtures or Freezium (EPDM).

The stainless steel valves are also suitable for drinking water, and they meet the requirements imposed by the decree of the Finnish Ministry of the Environment enacted in January 2020

concerning the type-approval of shut-off valves designed for water supply systems in buildings.

The Vexve X range of gas valves (coloured yellow) is designed for clean, gaseous media, and the primary application is natural gas systems. Gas ball valves can also be used in compressed air applications and other systems that use gaseous media – consult a Vexve expert to check the compatibility of the valve and the medium.

The Vexve X range of valves can be used within the limits shown in the temperature-pressure graphs below (pages 4–5).

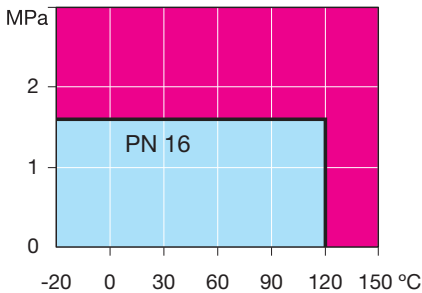

Graph 1. Pressure-temperature graph, all DN 10–50 balancing valves and valves with press fit connections



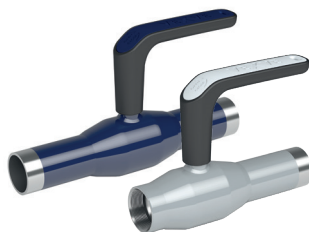
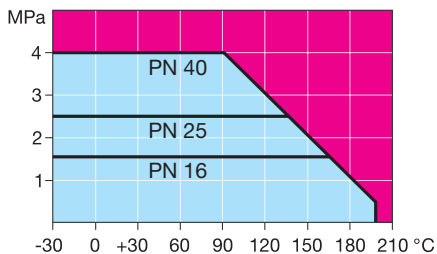

Graph 2. Pressure-temperature graph, DN 10–50 steel ball valves and stainless steel ball valves

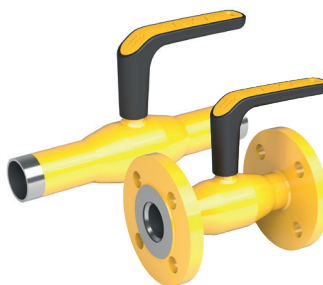
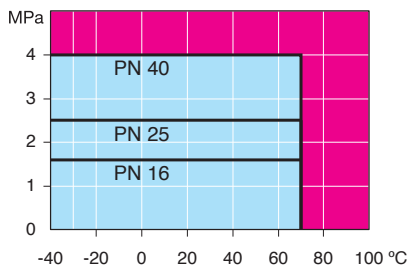

Graph 3. Pressure-temperature graph, DN 10–50 gas ball valves



Note:

If you intend to use the valve with other media or in other applications, contact Vexve to verify that the valve is compatible with the planned use.



Note:

The dimensions provided in these instructions refer to reduced-bore ball valves unless otherwise stated. The instructions may also be used for full-bore ball valves. However, when full-bore valves are used, the correct user guide is the one intended for a reduced-bore valve one size larger. For example, a DN 40 full-bore ball valve should be used in accordance with the instructions for a DN 50 reduced-bore valve.

The structure of the valves in the X range is shown in Appendices 6.1 and 6.2.

For more detailed technical information relating to the dimensions, weights, torques, Kv-values and other characteristics, see Vexve's product list and data sheets (www.vexve.com). Product information about the valves is also in the MagiCAD database.

2. Identifying the valve

The product plate is on the body of the valve. It contains the following information:

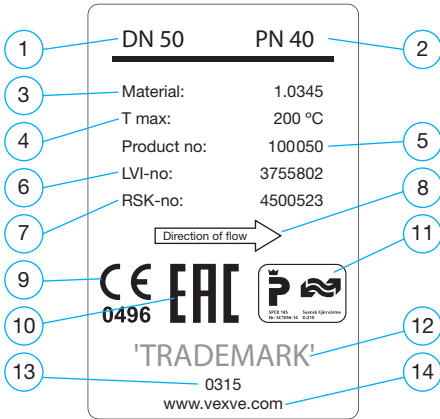

Figure 1. A product plate

1. DN size (nominal size) of the valve
2. Pressure class (PN)
3. Material of the valve's body
4. Maximum permitted operating temperature
5. Product number
6. LVI number
7. RSK number
8. Direction of flow (balancing valve)
9. CE marking and number of the notified body
10. EAC marking
11. Swedish valve certificate
12. Product brand
13. Year of manufacture
14. Manufacturer's website

STF TYPE-APPROVAL

Vexve's stainless steel valves are also suitable for domestic water, and they meet the requirements imposed by the decree of the Finnish Ministry of the Environment enacted in January 2020 concerning the type-approval of shut-off valves designed for water supply systems in buildings.

Vexve has received the following type-approvals:

- EUFI29-19003519-TH
- EUFI29-20001626-TH



The type-approval certificates are on the manufacturer's website: www.vexve.com.

Material certificate in accordance with EN10204 / 3.1 can be ordered separately.

3. Reception of consignments and storage

Check that the content of the delivery corresponds to the order. Also check that the valve and related accessories were not damaged in transit.

Store the valve carefully until it is installed. It is recommended to store the valve in a dry and well-ventilated place, such as a shelf or on a wooden pallet, where it is protected from rising damp.

The valve must be transported to the installation location in a robust package. The protective covers for the flow openings must be removed immediately before installation. The valve should be protected from sand, dust and other impurities.

The valve is delivered from the factory in the open position. The valve must remain in the open position during storage.

The maximum storage period is two years.

Package

Vexve's products come in packages designed for transportation. The packages are made from environmentally friendly material that is easy to sort and recycle.

We recommend recycling the packaging material.

The packaging material is wood, cardboard, paper and polyethylene plastic.

Recycling and disposal

Almost all of the components of the valve are manufactured from recyclable material. The material is marked on the majority of the components. Separate instructions on recycling and disposal are available from the manufacturer. For a fee, the valve can also be delivered to the manufacturer, who will recycle and dispose of the valve appropriately.

4. Valve installation using different connection methods



WARNING:

Incorrect installation may lead to severe personal injury and may damage the product or cause it to malfunction. For this reason, these instructions must be followed carefully when the valve is installed.

These instructions are general instructions, and they do not cover every possible usage condition. If you require further guidance related to using the valve or additional information on its suitability for the intended application, contact the manufacturer.

4.1 Installing a valve with a welded connection

Shielded metal arc welding is recommended. The recommended welding rod is an ESAB OK 48.00 or equivalent (standard: EN ISO 2560-A; classification: E 42 4 B 42 H5).

Welding

The valve must not overheat. Cool the valve during welding. One way to protect the valve seal from overheating is to place a wet fabric on the exterior surface of the valve near the seat. The welder should have the necessary qualifications.

The valve should be welded to the pipeline by 4–8 spot-welded joints before the weld seam is created. Spot welds should be made on alternating sides of the valve in turn.

The valve should be earthed via the valve body or pipeline during welding. The earthing cable should be connected to the same side of the valve as the welded seam so that the electrical current does not damage the valve's gasket. The valve must never be earthed via the stem bush, actuator flange, handle or actuator.

Installing the valve horizontally:

The valve must be open during welding to ensure that no welding contamination becomes affixed to the surface of the ball (see Figure 2.4).

Installing the valve vertically:

When the upper seam is welded, the valve must be open to ensure that no welding contamination becomes affixed to the surface of the ball (see Figure 2.1).

When the lower seam is welded, the valve must be closed to prevent it from overheating (see Figure 2.3).

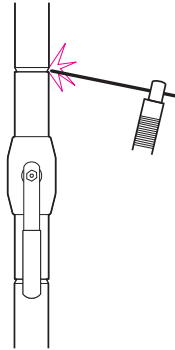

Figure 2.1

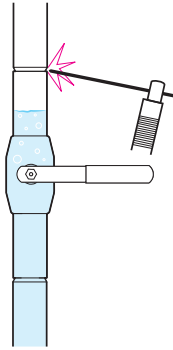

Figure 2.2

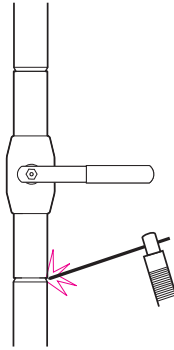

Figure 2.3

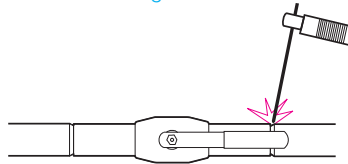

Figure 2.4

Figure 2.1 Vertical position

When the upper seam is welded, the valve must be open to ensure that no welding contamination becomes affixed to the surface of the ball.

Figure 2.2 Vertical position

If the valve is welded onto a vertical pipeline and the lower side of the valve is pressurised, the valve must be closed. The valve ball and ball seal should be protected from hot welding contamination by filling the upper side of the valve with at least 40 mm of water.

Note: when gas valves are welded, the lower side of the valve must never be pressurised.

Figure 2.3 Vertical position

When the lower seam is welded, the valve must be closed. If the valve is welded with gas, the valve must be in the open position, and it must be cooled thoroughly before the operation.

Figure 2.4 Horizontal position

The valve must be open.



Note:

Cool the valve after welding and before beginning normal use. The valve may not open/close until it has cooled down thoroughly.

4.2 Installing a valve with flanges

- Valves may only be installed by an authorised person. The applicable norms and standards should be observed during installation.
 - The valve must be open during installation to ensure that no contamination can damage the sealing surfaces.
 - The sealing surfaces of the pipeline and valve flanges must be parallel, and they must meet each other correctly.
 - The valve length (including flange seals) must be the same as the distance between the pipeline's flanges.
 - The pipeline flanges must be compatible with the valve flanges. For detailed information on flanges, see the EN1092-1 standard and [the manufacturer's website](#).
- The screws and nuts used in the connection must be suitable for the conditions prevailing in the location of the valve. The screws and nuts must also meet the requirements applying to the pressure, temperature, flange material and sealant. For detailed information on this topic, see the EN 1515-1, EN 1515-2 and 1515-4 standards.
 - The seal must be suitable for the operating conditions, and it must meet the requirements applying to the pressure, temperature and medium. The dimensions of the seal must be compatible with the dimensions of the seal surfaces. For detailed information on this topic, see the EN 1514 standard.
 - It is recommended to install the valve with the stem horizontal or vertically upwards.

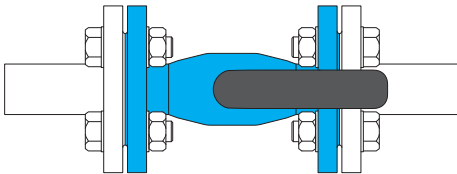

Figure 3. Stem in the horizontal position

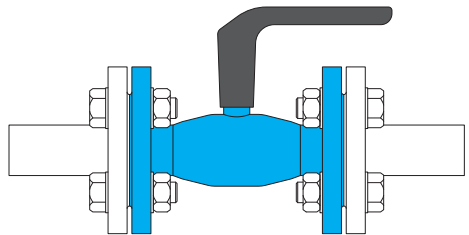

Figure 4. Stem in the vertical position

4.3 Installing threaded valves

The female threads of Vexve valves are pipe threads (Rp internal thread according to the EN 10226-1 standard, also known as a cylindrical female thread). The threads provide ample space for sealing material.

Seal the threads using materials and methods designed for the purpose. These include duct tape, thread-locking fluid, or hemp and sealing putty. Do not use excessive amounts of sealing material. Particular care should be taken when using hemp and sealing putty. The rule of thumb is that the tops of the threads should remain visible. Bear in mind that hemp expands when wet.

Check that the connecting threads have compatible lengths and tolerances. At least two-thirds of the total thread length should be used.

When thread-locking fluid is used, the entire thread length of the connecting components should be used, and they should be sufficiently tight. Note: the connection must never rely solely on glue.

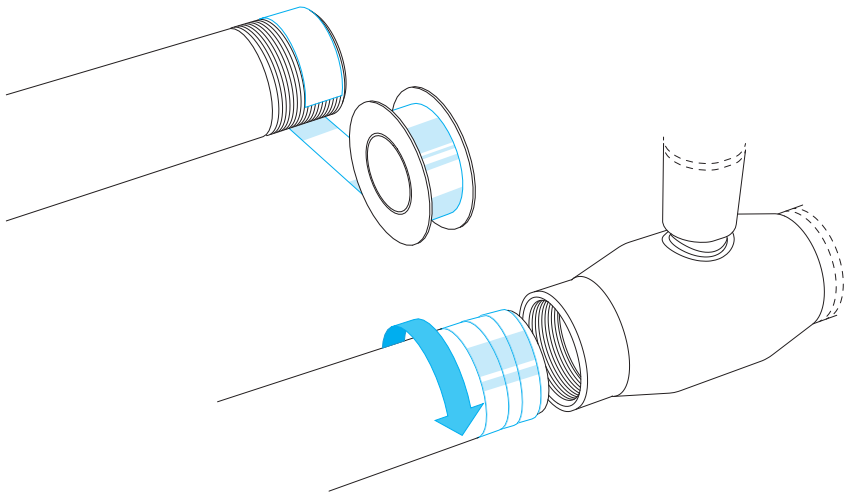

Figure 5. Sealing and connecting a threaded connection

4.4 Compatibility of press fit valves and installation

4.4.1 Compatibility of press fit valves

Vexve's steel ball valves with press fit connections are suitable for thin-walled steel pipes in accordance with the EN 10305 standard.

The stainless steel ball valves are suitable for stainless thin-walled steel pipes in accordance with the EN 10312 standard.

The adjacent list shows the compatibility of various media with the O-ring on the press fit valve (CIIR/EPDM).

Compatibility of the O-ring:

- heating water
- cooling water without antifreeze
- cooling water with antifreeze
- district heating water $\leq 120^{\circ}\text{C}$
- fire fighting water (wet)
- sprinkler (wet)
- compressed air (oil purity class 0–3)

4.4.2 Installation of press fit valves

- M and V profile press jaws are suitable for pressing.
- the compressive force of the pressing machine used to press valve sizes 18–35 mm must be at least 19 kN.
- Loop-type press jaws are suitable for pressing valve sizes 42–54 mm, and the compressive force of the press tool must be at least 32 kN.
- The protective covers for the flow openings must only be removed immediately before installation. The valve should be protected from sand, dust and other impurities.
- Take great care when you test the valve before fitting it to the pipe network.
- The valve must not be lifted by the handle or control knob. Dropping the valve or lifting it incorrectly may lead to severe personal injury or product damage.



Note:

The valve should only be used in the applications for which it is intended.

Immediately before installation:

- Remove the protective covers for the flow openings (shut-off valve) and check that the internal surfaces of the valve are clean and the leak before press (LBP) O-rings at the ends of the press connection are in place and undamaged.
-



WARNING:

The end of the pipe to be connected must be cut straight and all sharp burrs must be removed carefully from the external and internal surfaces. Any impurities in the valve or pipe could damage the valve or its coupling heads.

4.4.3 Making a press fit connection

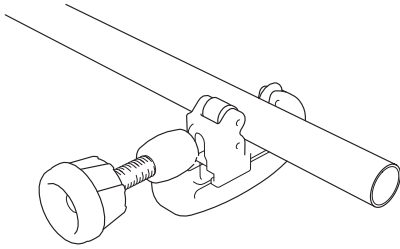

1. Cutting the pipe

Cut the pipe using a tool intended for cutting thin-walled pipes.

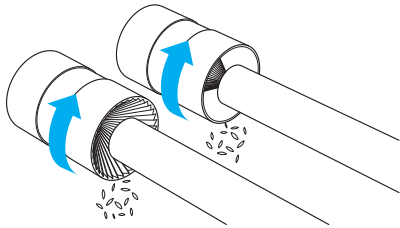

2. Removing burrs

Remove all burrs from the cut pipe using a tool intended for the purpose.

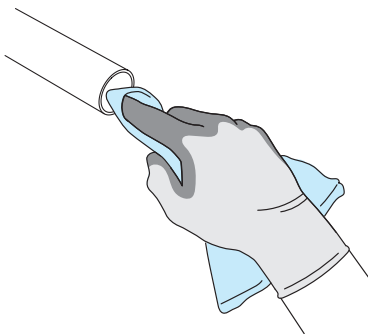

3. Cleaning

Clean any loose debris from the coupling head and check that there are no sharp burrs on it.

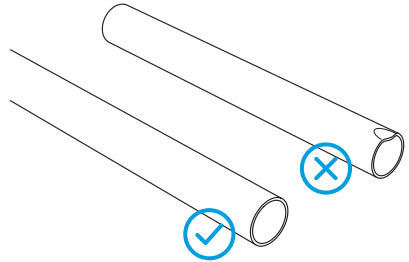

4. Check the coupling heads

Check the coupling head of the pipe: it must be circular and undamaged.

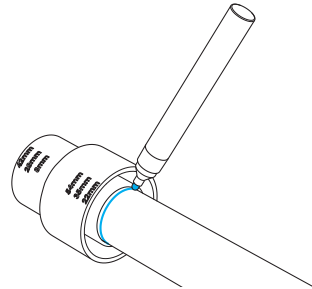

5. Marking the installation depth

Mark the correct installation depth on the pipe using the Vexve installation depth gauge.

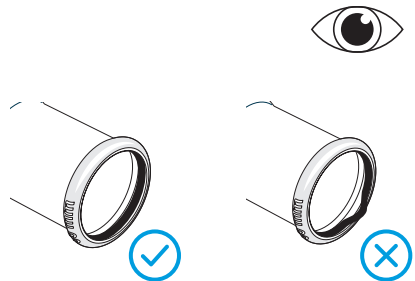

6. Checking the coupling heads of the valve

Visually inspect the valve's coupling head for any damage and ensure that the O-ring is in place in its groove.

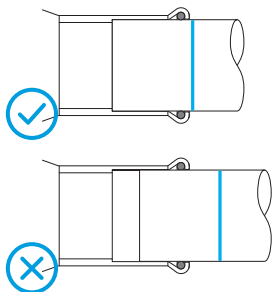
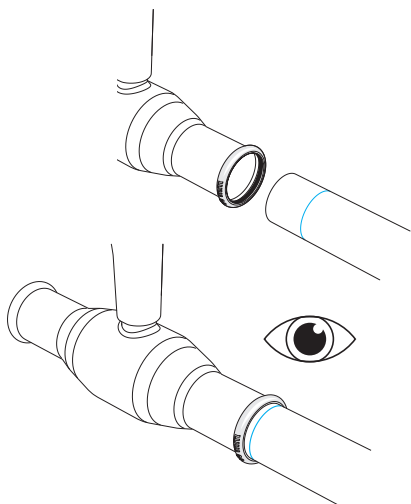

7. Fitting the pipe into the valve

Fit the coupling head of the pipe into the valve to the fullest extent and ensure that the installation depth marking matches up.

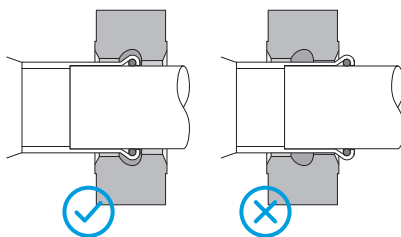

8. Check before pressing

Before pressing, check that the O-ring groove on the valve meets the groove on the tool.

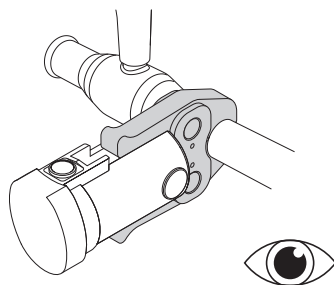

9. Pressing the connection

Press the connection using a standard-compliant M or V profile pressing tool intended for pressing thin-walled steel pipes.

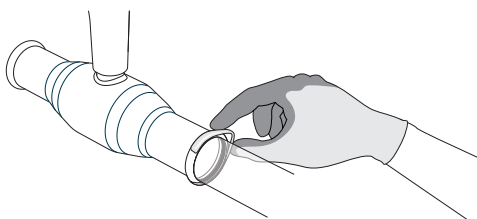

10. Removing the press collar

Remove the cracked press collar by hand if it does not detach of its own accord.

4.5 Minimum installation distances

Minimum installation distances:

In the Figure, D = the diameter of the pipeline

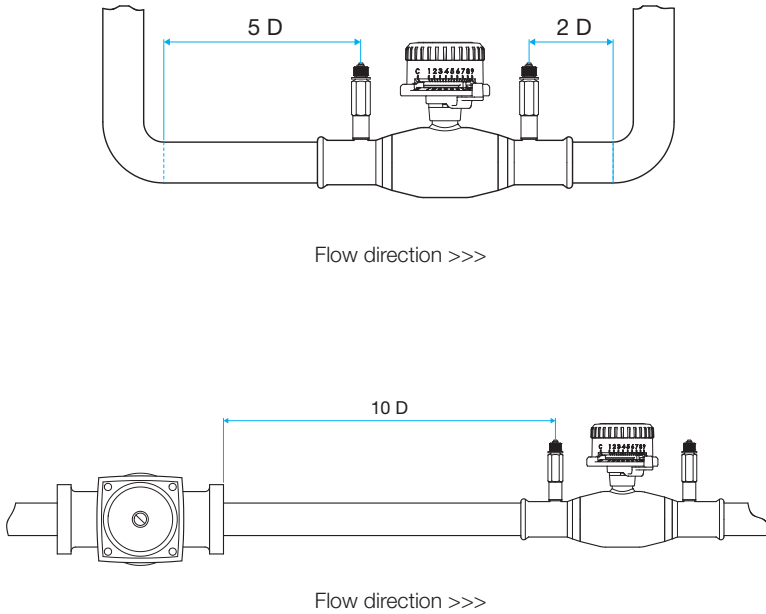

Figure 6. Minimum installation distances



Note:

It is recommended to install the valve with the stem horizontal or vertically upwards.

4.6 Installation on the end of the pipe



Note:

The valve must not be used as a terminal for the pipe – a cap plug must always be fitted to the other side of the valve (see Figures 7 and 8).

If the valve is installed onto the end of a pipeline, there is a danger of corrosive, acidic water or air collecting in the empty end of the valve. To prevent corrosion, there must be oxygen-free water in the section beyond the valve.

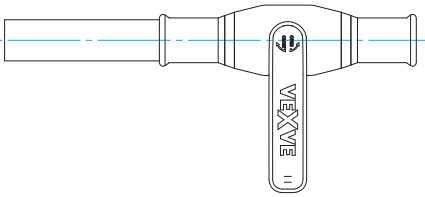

Figure 7. The valve must not be used as a terminal for the pipeline

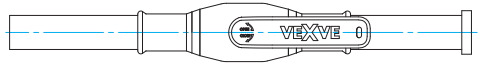

Figure 8. Cap plug. There must be at least 200 mm of pipe between the valve and the cap plug



Note:

If the valve and the cap plug are installed as the terminal for a pipeline, the valve must be completely in the open position. A closed area must not be allowed to arise between the valve and the cap plug because the valve may be damaged if the water expands in a closed area (for example, due to a change in temperature).

4.7 Commissioning and pressure testing

Exceeding the permitted values shown on the valve may damage the valve and, in the worst case, lead to an uncontrolled pressure discharge. This can damage the product and could also cause personal injury and property damage. When the valve is closed, the maximum permitted testing pressure is 1.1xPN. While the pipeline is being pressure-tested (1.5xPN), the valve must be opened.

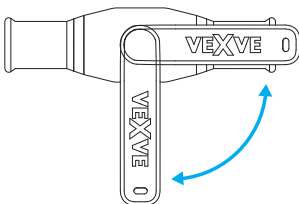

Figure 9. Check that the valve is either fully open or fully closed

4.8 Balancing valves

4.8.1 Determining the preset value for the balancing valve

The desired Kv-value can be preset for the valve:

- If the desired Kv-value is known, the suitable valve size and preset value can be verified using Table 1.
- If the desired Kv-value is not known, the suitable valve size and preset value can be determined using Kv curves (pages 23–25) if the valve's volume flow rate and pressure loss are known.

Preset value	DN 15	DN 20	DN 25	DN 32	DN 40	DN 50
1,0	-	0,04	0,19	0,22	0,48	0,71
1,5	0,04	0,07	0,35	0,41	0,6	1,29
2,0	0,06	0,12	0,56	0,61	0,82	2,09
2,5	0,11	0,20	0,77	0,85	1,29	3,10
3,0	0,18	0,30	1,10	1,21	1,84	4,02
3,5	0,25	0,45	1,41	1,67	2,47	5,11
4,0	0,33	0,63	1,80	2,17	3,29	6,48
4,5	0,45	0,83	2,29	2,68	4,19	8,20
5,0	0,59	1,02	2,86	3,46	5,44	10,43
5,5	0,72	1,51	3,60	4,50	7,05	13,01
6,0	0,90	2,10	4,63	5,89	9,09	16,25
6,5	1,13	2,72	5,62	7,35	11,45	20,39
7,0	1,42	3,52	6,77	9,14	13,99	24,53
7,5	1,70	4,39	8,35	11,01	17,09	29,30
8,0	2,04	5,40	9,96	12,85	20,24	34,13
8,5	2,32	6,66	11,76	15	22,78	37,10
9,0	2,61	8,18	13,75	17,29	25,14	39,73

Table 1. Kv-values for Vexve's X balancing valves



Note:

The Vexve X range of balancing valves is in the libraries of TA-SCOPE and SmartBalancing measurement devices, among others. Information about the Vexve X range will be published at the same time as the update, which will be released by the date when calibration is carried out. If the measurement device does not have any information about the Vexve X range, the valve can be adjusted on the basis of the Kv table above.

4.8.2 Setting the preset values

See Figure 10

Balancing valves

1. Set the limiter (2) to the specified preset value (1)
2. Adjust the hand (3) so it rests on the edge of the limiter (2)

Note: If preset value C is selected, the valve will function as a shut-off valve.

4.8.3 Measuring the valve's flow rate

The valve's volume flow rate can be measured using a separate flowmeter. These devices measure the pressure on both sides of the valve and calculate the pressure loss caused by the valve on the basis of the measurements. The measuring device determines the flow rate based on the pressure loss and the Kv-value corresponding to the valve's preset value. Contact Vexve Oy for additional information on suitable flowmeters.

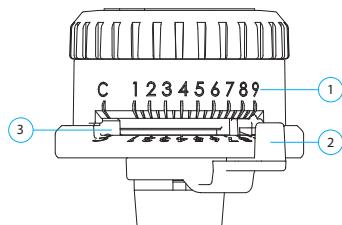

Figure 10.
Setting the preset value

5. Maintenance

Vexve's X range of valves is maintenance-free in practice.

The need for maintenance is significantly reduced by selecting the correct valve for the application and ensuring error-free installation, commissioning and use.



Warning:

When the valve is connected to the pipeline, the temperature of the external surface may be dangerously high. Protect yourself from burns.

We recommend regularly checking the following:

- Check that the valve's surface is not damaged and that there are no discernible leaks from the stem structure.
- Repair any damage carefully.

In the event that the valve is used rarely (ten times per year or fewer), we recommend checking the following to ensure the long-term reliability of the valve:

- Check that there are no discernible leaks from the stem structure, check the condition of the handle or control knob, and check that the measuring blocks are sealed.

5.1 Replacing the O-ring in the X range of valves

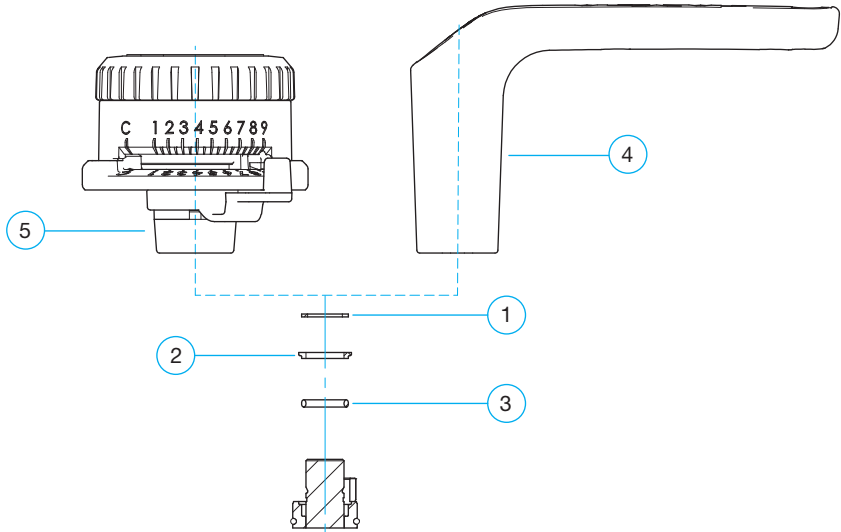

- Remove the handle or control knob by pulling hard on it directly upwards
- Remove the retaining ring
- Remove the stem sealing bush
- Remove the damaged O-ring
- Put the new O-ring in place by pressing the upper surface evenly downwards
- Put the new stem sealing bush in place by pressing the upper surface evenly downwards
- Put the new retaining ring in place
- Put the removed handle or control knob back in place

	Component	Steel	Stainless steel
1	Retaining ring	299417	289116
2	Stem sealing bush	901088	901088
3	O-ring	901107	901108
4	Handle	901115	901115
5	Control knob	901130S	901130H
6	Controller (press fit connection)	901130T	901130H

6. Appendices

6.1 Structure of balancing valves < DN 50

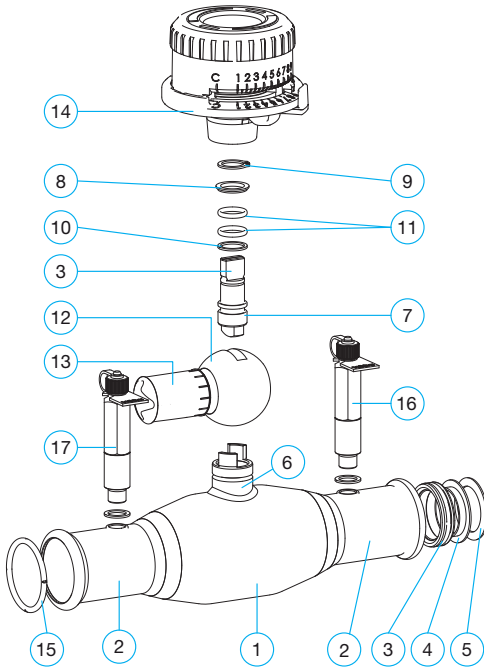

Component number	Component	Units
1	Body	1
2	Extension pipe, pressed	2
3	Ball seal	2
4	Support plate	2
5	Spring plate	2
6	Stem bush	1
7	Stem	1
8	Stem sealing bush	1
9	Retaining ring	1
10	Sliding plate	1
11	O-ring	2
12	Ball	1
13	Flow pipe	1
14	Precision control knob	1
15	LBP O-ring	2
16	Measuring block, blue	1
17	Measuring block, red	1

6.2 Structure of shut-off valves < DN 50

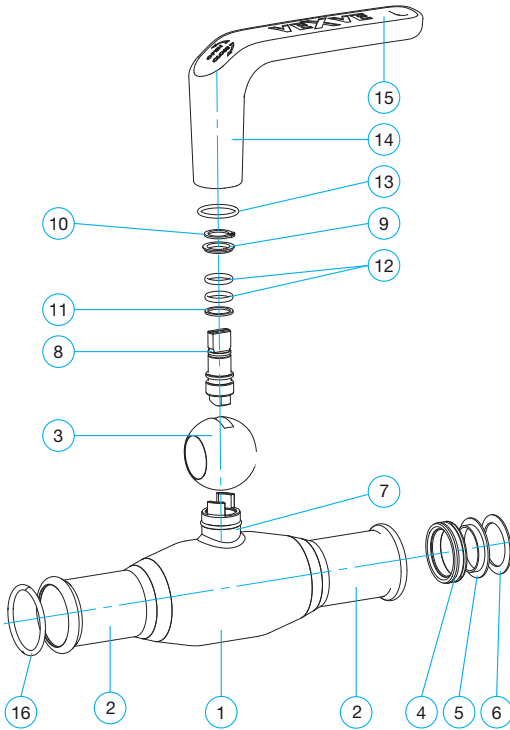

Component number		units
1	Body	1
2	Extension pipe, pressed	2
3	Ball	1
4	Ball seal	2
5	Support plate	2
6	Spring plate	2
7	Stem bush	1
8	Stem	1
9	Stem sealing bush	1
10	Retaining ring	1
11	Sliding plate	1
12	O-ring	2
13	O-ring	1
14	Handle	1
15	Handle cover	1
16	LBP O-ring	2

6.3 Kv curves for balancing valves

DN 15

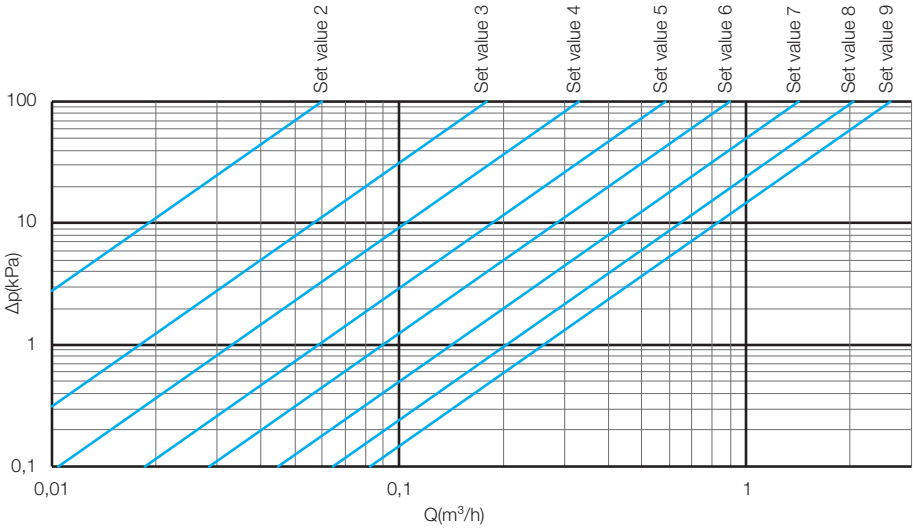

DN 20

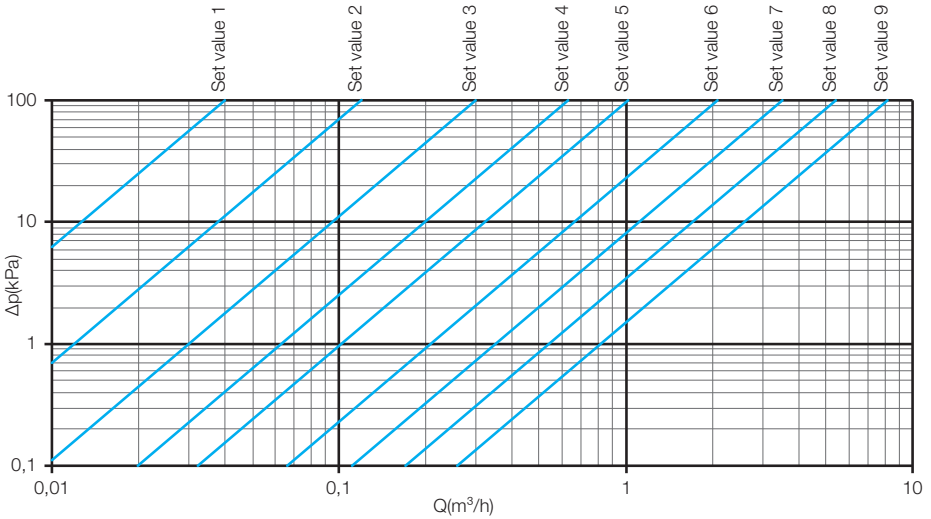

DN 25

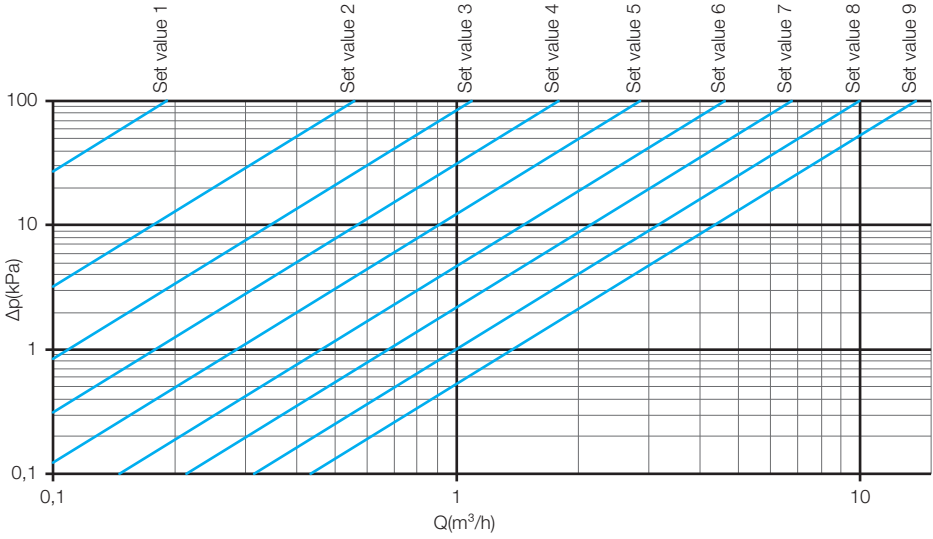

DN 32

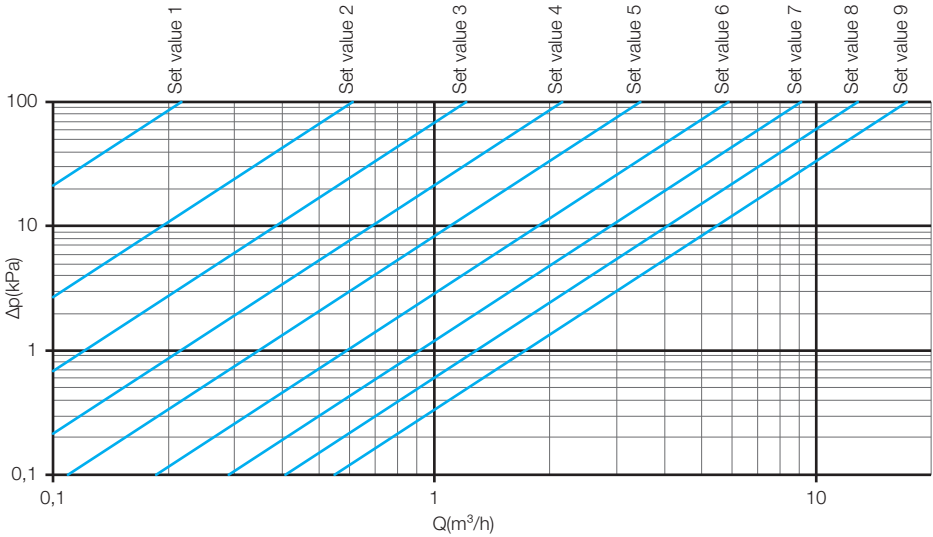

DN 40

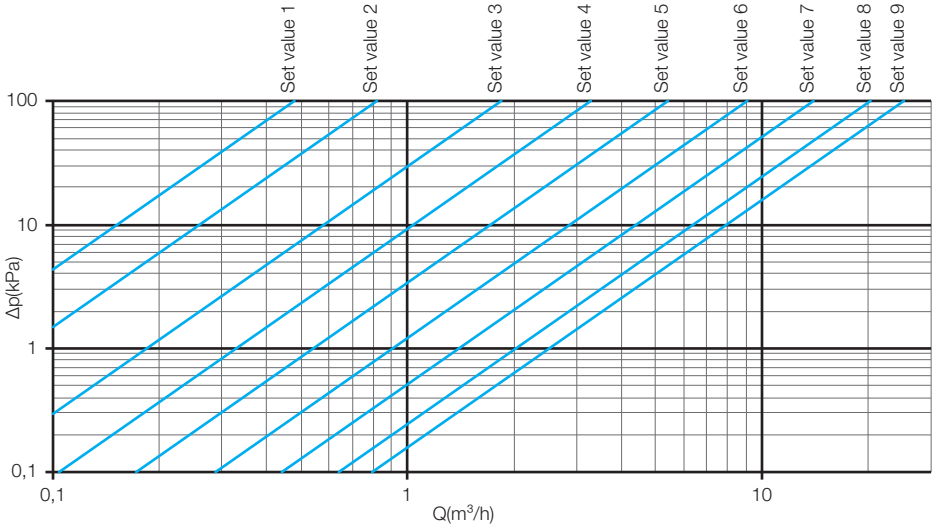

DN 50

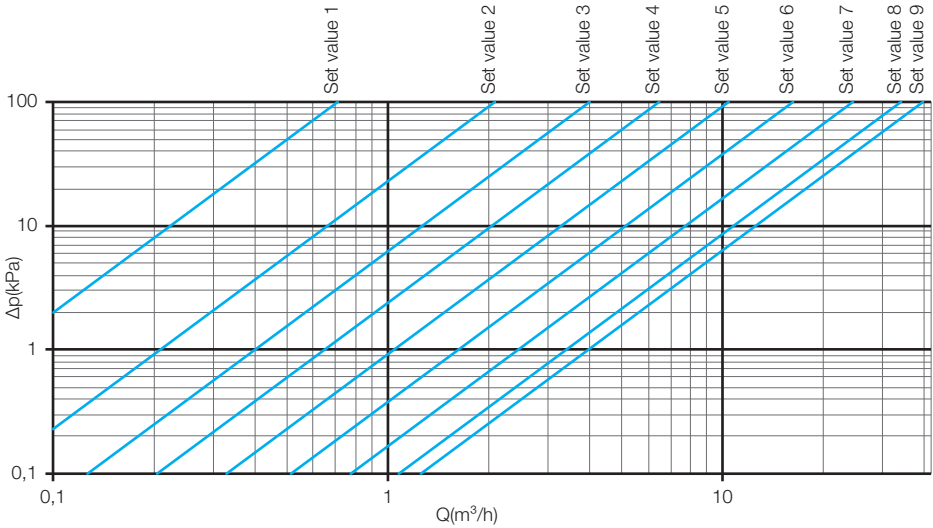

6.4 Kv curves for shut-off valves

DN 15–50, reduced bore

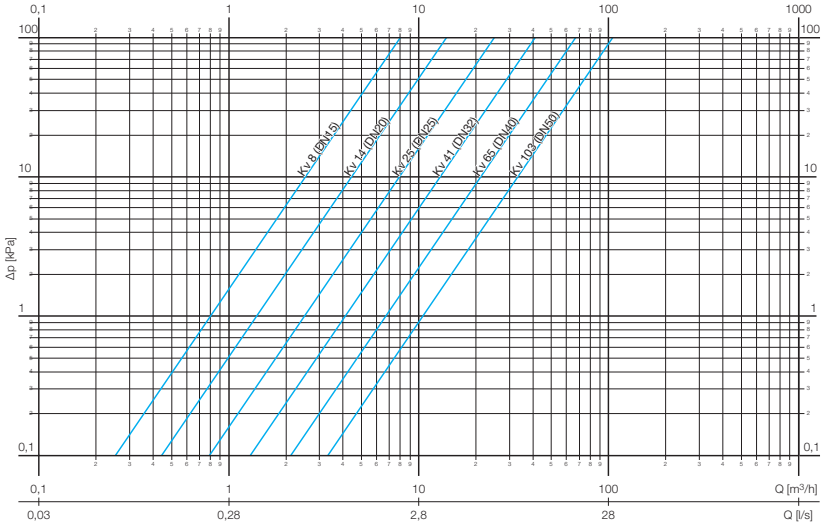

DN 10–40, full bore

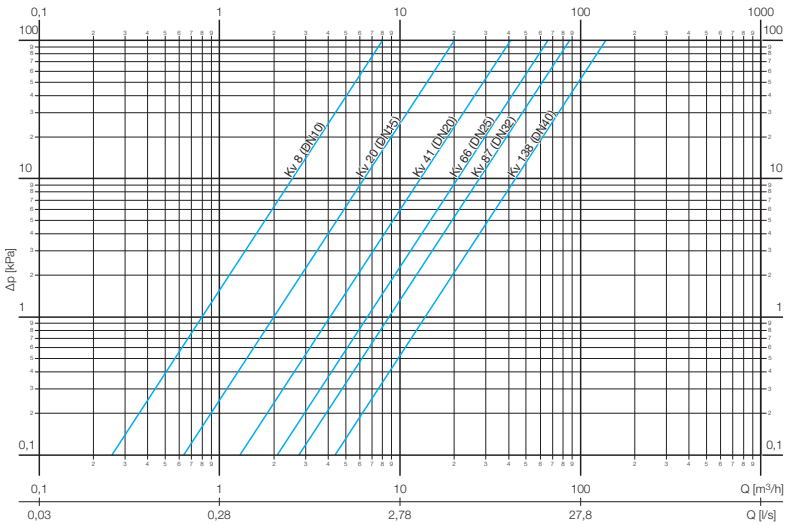

6.5 Kv values for shut-off valves

DN size	Kv value	
	Reduced bore	Full bore
10		8
15	8	20
20	14	41
25	25	66
32	41	87
40	67	139
50	106	



Note: Kv values for water

6.6 Coupling dimensions DN 10–50

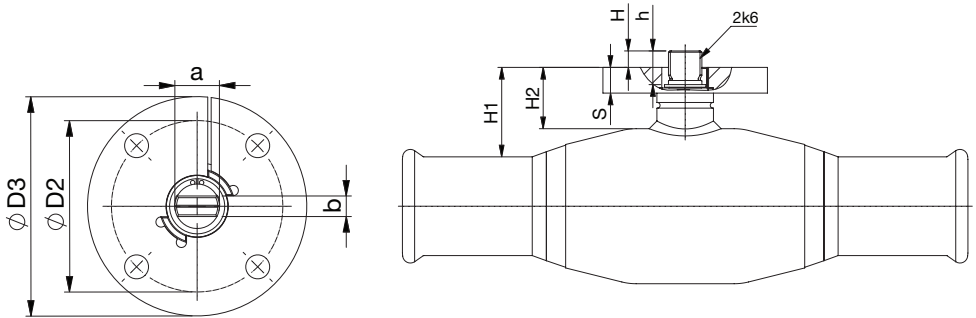

DN	H1	H2	H	h	S	a	b	D2	D3
DN 15	41,4	35,2	6,4	11,5	10	13	6	50	64
DN 20	42,6	34,8	6,4	11,5	10	13	6	50	64
DN 25	41,2	33,9	6,4	11,5	10	13	6	50	64
DN 32	40,8	31,9	6,4	11,5	10	13	6	50	64
DN 40	42,4	31,5	6,4	11,5	10	13	6	50	64
DN 50	43,4	35,5	6,4	11,5	10	13	6	50	64
Toler.									

6.7 Torque DN 10–50

DN size reduced bore	DN size full bore	Torque	Max. pressure class
DN 15	DN 10	1 Nm	PN 40
DN 20	DN 15	2 Nm	
DN 25	DN 20	4 Nm	
DN 32	DN 25	6 Nm	
DN 40	DN 32	8 Nm	
DN 50	DN 40	12 Nm	



Note:

A torque value of 20 Nm should be used to dimension the actuators.



Vexve Oy

Pajakatu 11
38200 Sastamala
Finland

Riihenkalliontie 10
23800 Laitila
Finland

Tel. +358 10 734 0800
vexve.customer@vexve.com

www.vexve.com