

Hydro Multi-E

CR(I)E

 GRUNDFOS
PRESSURE BOOSTING





1

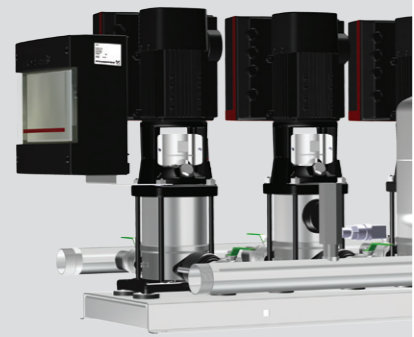

2



3

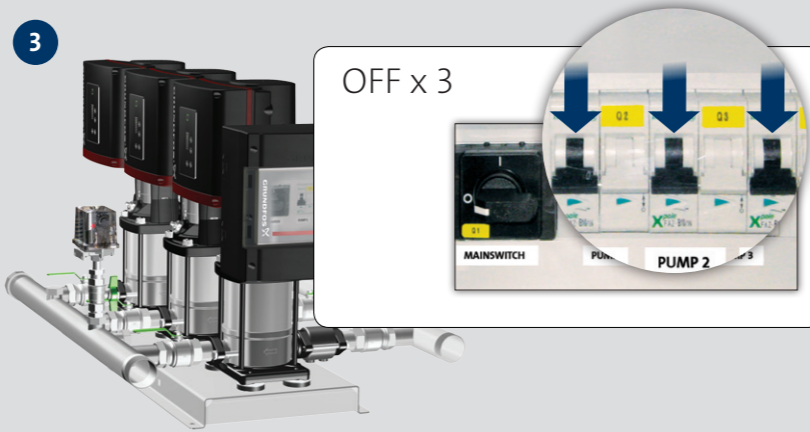

4

Factory settings	
Date	Setting (SP)

Customer settings		
Date	Setting (SP)	Initials



$P = 0.7 \times \text{SP}$

$P = 0 \text{ bar}$



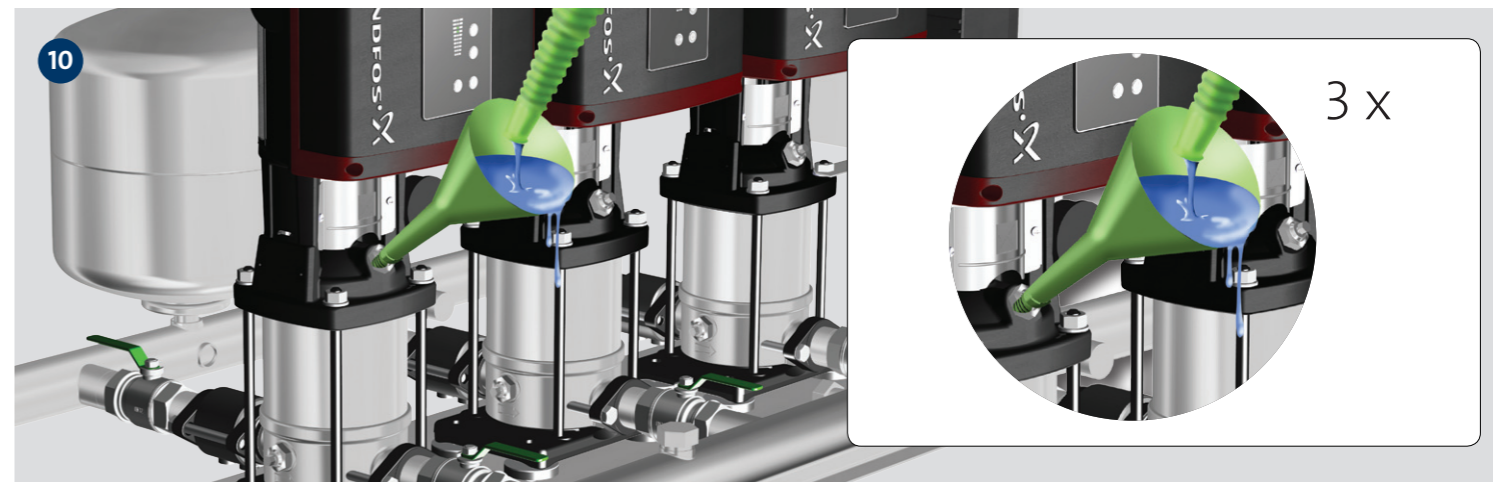
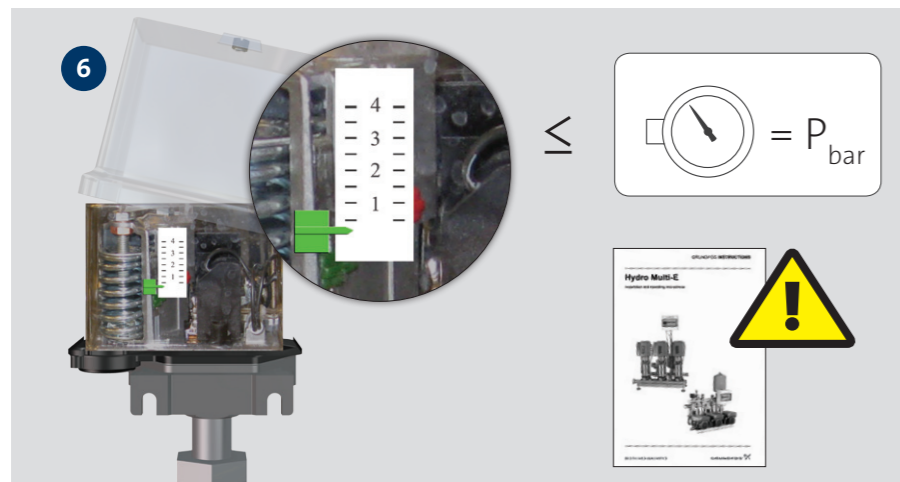
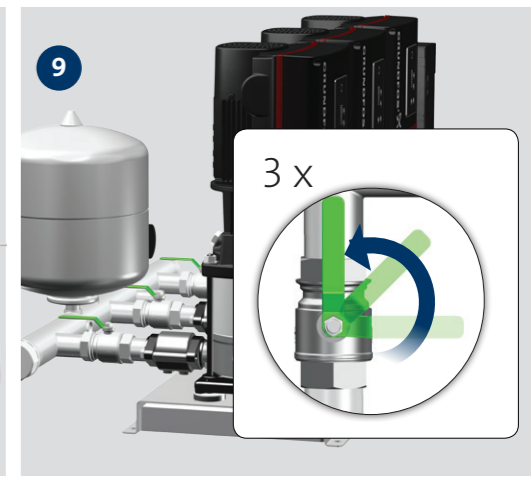
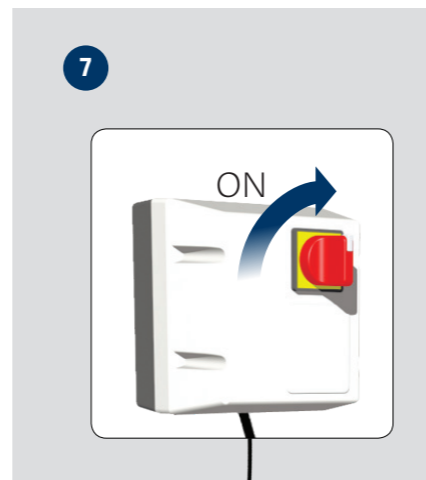
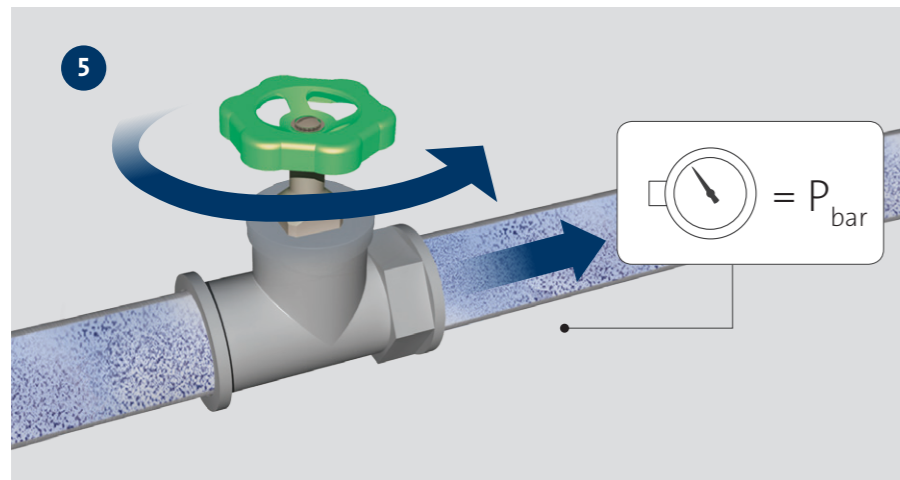



11

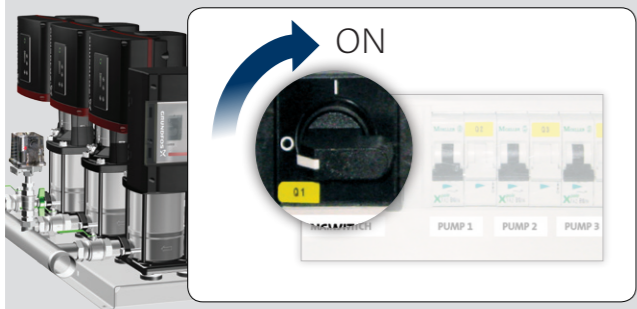

12

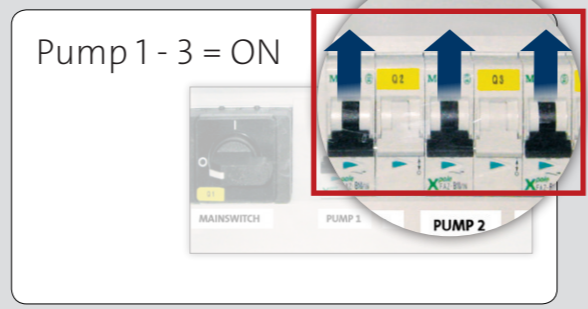

15

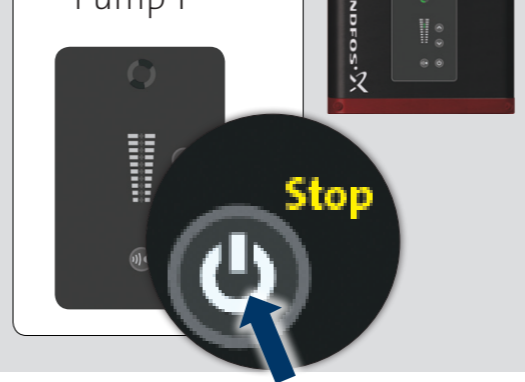

16



13

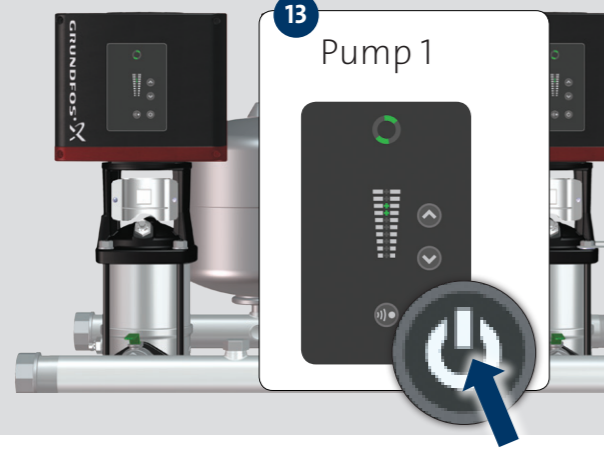

14

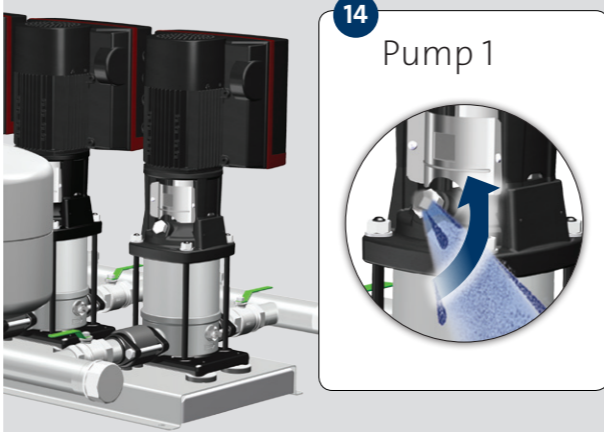

17

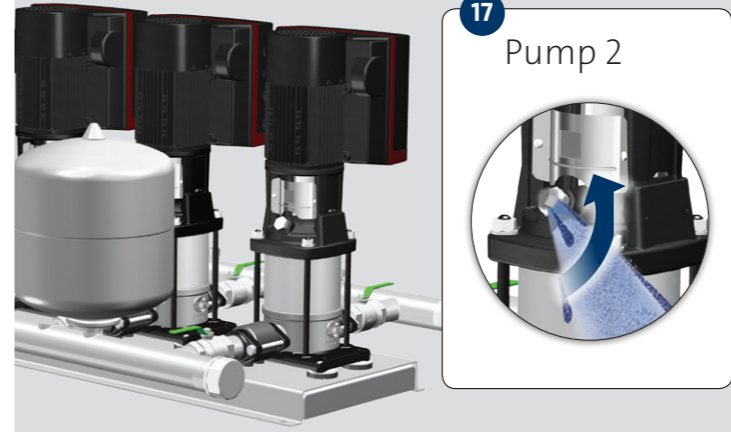

18

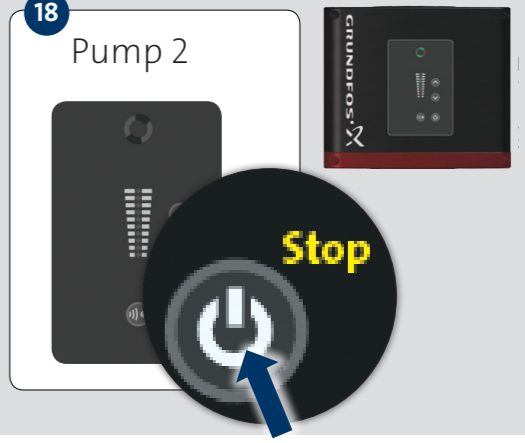

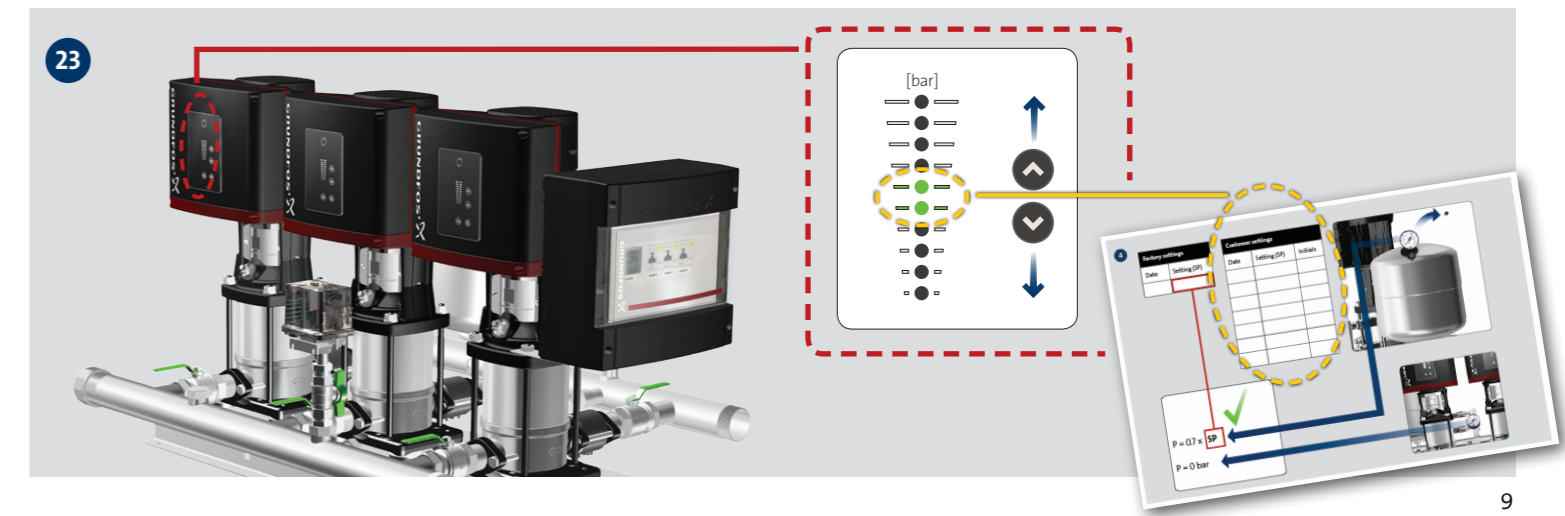
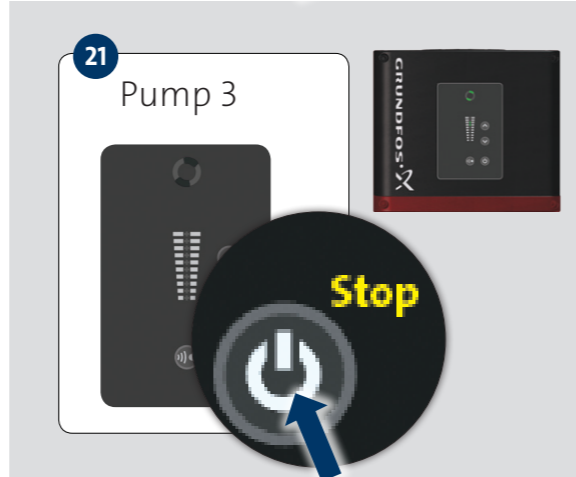
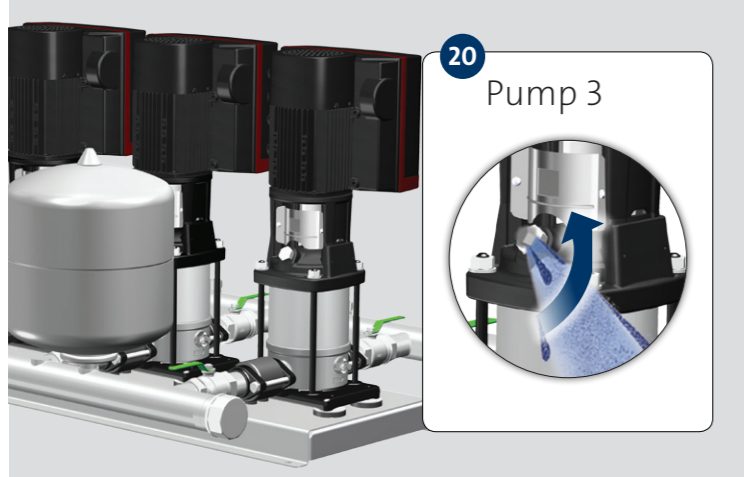
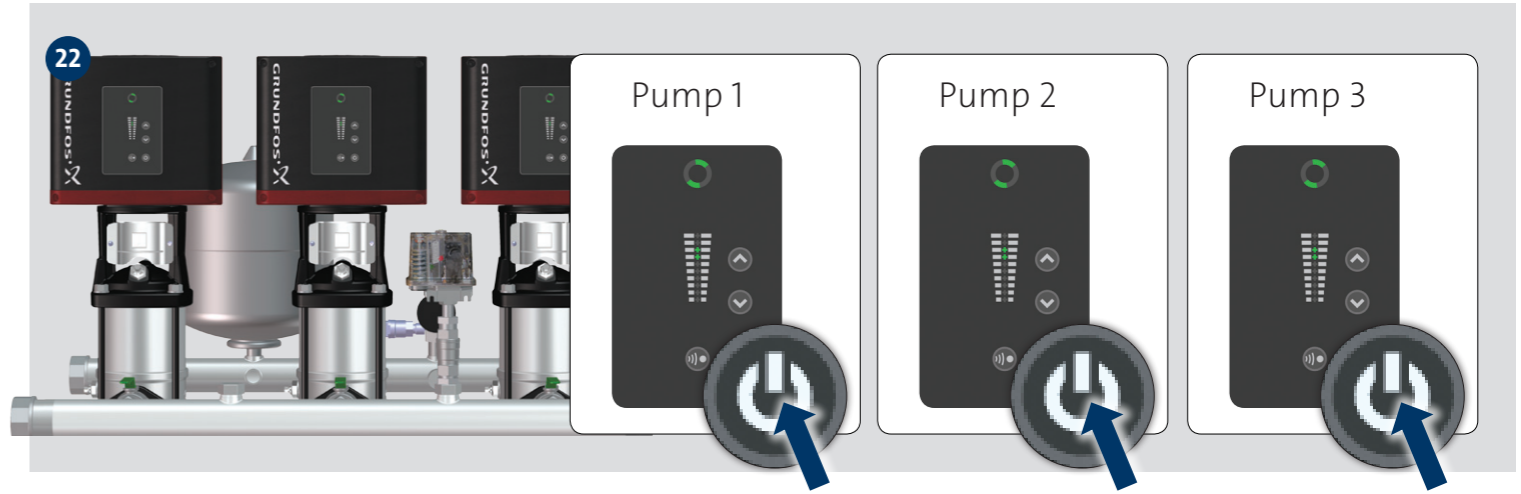



24

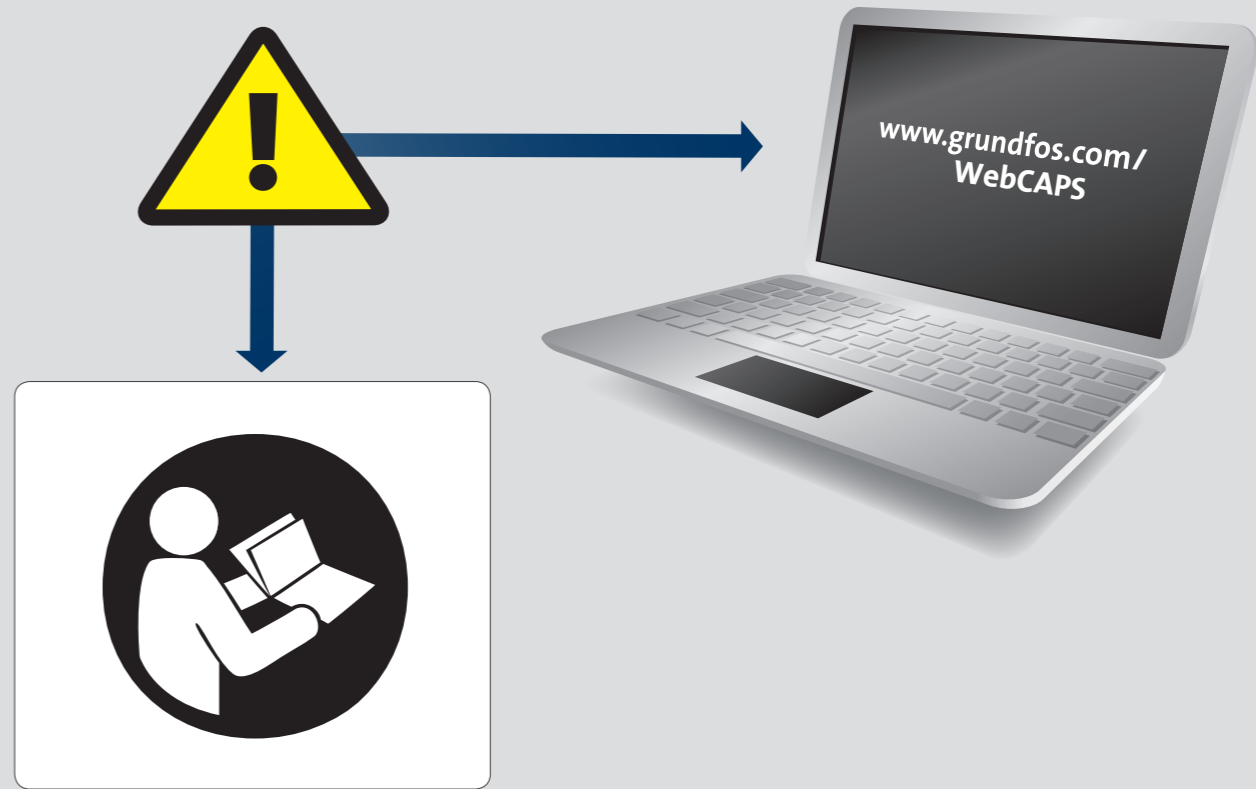

98477592 0713

ECM: 1117625

be think innovate

GRUNDFOS 

The name Grundfos, the Grundfos logo, and the phrase be think innovate, are registered trademarks owned by Grundfos Holding A/S or Grundfos A/S, Denmark. All rights reserved worldwide.